



**Pb-free  
HEAT**



# 1101W Series

Single Color 3216 Type  
(High Reliability type, V-Series)

## Product features

Package	3216 Type, Water Clear resin
Product features	<ul style="list-style-type: none"> <li>• Outer Dimension 3.0 x 1.5 x 1.5mm ( L x W x H )</li> <li>• Wide operation temperature range. Storage Temperature : InGaN :-40°C~110°C : AlGaInP : -40°C~120°C</li> <li>• Operating Temperature : -40°C~100°C Operation Guarantee</li> <li>• Ramification of luminosity group sorting. It is possible to have a uniform transmission with little irregularities even when several are lined up.</li> <li>• Systematization of luminosity groups and color tone groups. Unified to a simple standard.</li> <li>• Corresponding to a use requiring high reliability in cars etc...</li> <li>• Lead-free soldering compatible</li> <li>• RoHS compliant</li> </ul>
Dominant wavelength	Blue : 470nm (VUB) Green : 530nm (VUG) , 562nm(VYBG) Yellow Green : 572nm (VYPY) Yellow : 590nm (VFY) Orange : 605nm (VFA) Red : 615nm (VFV) , 626nm (VFR)
Spatial distribution	VUB,VUG : $\theta_x = 140 \text{ deg.}, \theta_y = 145 \text{ deg.}$ VYBG,VYPY,VFY,VFA,VFV,VFR : $\theta_x = 140 \text{ deg.}, \theta_y = 140 \text{ deg.}$
Die materials	VUB,VUG : InGaN VYBG, VYPY, VFY, VFA, VFV, VFR :AlGaInP
Optical efficiency	VUB : 9.1lm/W                      VUG : 21.2lm/W VYBG : 1.1lm/W                    VYPY : 3.1lm/W VFY : 7.9lm/W                      VFA : 7.9lm/W VFV : 11.8lm/W                    VFR : 7.9lm/W
Rank grouping parameter	Sorted by luminous intensity and wavelength and taped according to rank.
Assembly methods (customer)	Corresponding to surface mounter.
Soldering methods	Corresponding to reflow soldering and manual soldering.
Taping dimensions	2,500pcs(standard) per reel in a 8mm width tape. Reel diameter : $\phi$ 180mm
ESD	AlGaInP : 2kV (HBM)              InGaN : 1kV (HBM)

## Recommended Applications

SW lighting for car indicators, meter panel, car audio and heater control, etc...

## Color Variations and Luminous Intensity

(Ta=25°C)

Part No.	Material	Emitted Color	Lens Color	Dominant Wavelength		Luminous Intensity			Luminous Flux	
				$\lambda d$ (nm)		$I_v$ (mcd)			$\phi_v$ (mlm)	
				TYP.	$I_F$	MIN.	MAX.	$I_F$	TYP.	$I_F$
VUB1101W	InGaN	Blue	Water Clear	470	10	15	56	10	300	10
VUG1101W	InGaN	Green		530	10	47	180	10	700	10
VYBG1101W	AlGaInP			562	20	5.6	27	20	45	20
VYPY1101W	AlGaInP	Yellow Green		572	20	18	68	20	130	20
VFY1101W	AlGaInP	Yellow		590	20	39	150	20	300	20
VFA1101W	AlGaInP	Orange		605	20	39	120	20	300	20
VFV1101W	AlGaInP	Red		615	20	68	220	20	450	20
VFR1101W	AlGaInP			626	20	39	150	20	300	20

※Note : The luminous intensity( $I_v$ ) and dominant wavelength ( $\lambda d$ ) above are the setup values of the sorting machine.  
(Tolerance :  $I_v$ ...  $\pm 10\%$ ,  $\lambda d$  ...  $\pm 1\text{nm}$ )

## Absolute Maximum Ratings

(Ta=25°C)

Item	Symbol	Absolute Maximum Ratings								Unit
		VUB	VUG	VYBG	VYPY	VFY	VFA	VFV	VFR	
Power Dissipation	$P_d$	84	84	81	81	78	78	78	78	mW
Forward Current	$I_F$	20	20	30	30	30	30	30	30	mA
Pulse Forward Current ※1	$I_{FRM}$	48	48	100	100	100	100	100	100	mA
Derating (Ta=75°C or higher)	$\Delta I_F$	0.40※2	0.40※2	1.0	1.0	1.0	1.0	1.0	1.0	mA/°C
	$\Delta I_{FRM}$	0.96※2	0.96※2	3.33	3.33	3.33	3.33	3.33	3.33	mA/°C
Reverse Voltage	$V_R$	5	5	5	5	5	5	5	5	V
Operating Temperature	$T_{opr}$	-40~+100								°C
Storage Temperature	$T_{stg}$	-40~+110		-40~+120						°C

 ※1  $I_{FRM}$  Measurement condition : Pulse Width  $\leq$  1ms., Duty  $\leq$  1/20.

※2 Temperature Condition: Ta=60°C or higher.

## Thermal Characteristics

Item	Symbol	Ratings								Unit
		VUB	VUG	VYBG	VYPY	VFY	VFA	VFV	VFR	
Junction Temperature (MAX.)	$T_j$	110	110	120	120	120	120	120	120	°C
Thermal Resistance (TYP.) (Junction/ ambient)	$R_{(th j-a)}$	600	600	700	650	650	650	650	650	°C/W

 ※ $R_{(th j-a)}$  Measurement Condition/ Substrate: FR4(t=1.6mm) Pattern Size: 16mm<sup>2</sup>.

## Electro-Optical Characteristics (VUB, VUG)

(Ta=25°C)

Item	Conditions	Symbol	Characteristic Ratings		Unit	
			VUB	VUG		
Forward Voltage	I <sub>F</sub> =10mA	V <sub>F</sub>	TYP.	3.3	3.3	V
			MAX.	3.8	3.8	
Reverse Current	V <sub>R</sub> =5V	I <sub>R</sub>	MAX.	100	100	μ A
Peak Wavelength	I <sub>F</sub> =10mA	λ <sub>p</sub>	TYP.	465	522	nm
Dominant Wavelength	I <sub>F</sub> =10mA	λ <sub>d</sub>	TYP.	470	530	nm
Spectral Line Half Width	I <sub>F</sub> =10mA	Δλ	TYP.	26	35	nm
Half Intensity Angle	I <sub>F</sub> =10mA	2θ 1/2	TYP.	140(θ x)	140(θ x)	deg.
				145(θ y)	145(θ y)	

※Note: The dominant wave length (λ<sub>d</sub>) above is the setup value of the sorting machine.  
(Tolerance : λ<sub>d</sub>...±1nm)

## Electro-Optical Characteristics (VYBG, VYPY, VFY, VFA, VFV, VFR)

Item	Conditions	Symbol	Characteristic Rating						Unit	
			VYBG	VYPY	VFY	VFA	VFV	VFR		
Forward Voltage	I <sub>F</sub> =20mA	V <sub>F</sub>	TYP.	2.1	2.1	1.9	1.9	1.9	1.9	V
			MAX.	2.5	2.5	2.4	2.4	2.4	2.4	
Reverse Current	V <sub>R</sub> =5V	I <sub>R</sub>	MAX.	100	100	100	100	100	100	μ A
Peak Wavelength	I <sub>F</sub> =20mA	λ <sub>p</sub>	TYP.	565	575	592	609	624	635	nm
Dominant Wavelength	I <sub>F</sub> =20mA	λ <sub>d</sub>	TYP.	562	572	590	605	615	626	nm
Spectral Line Half Width	I <sub>F</sub> =20mA	Δλ	TYP.	15	15	15	15	15	15	nm
Half Intensity Angle	I <sub>F</sub> =20mA	2θ 1/2	TYP.	140(θ x)	140(θ x)	140(θ x)	140(θ x)	140(θ x)	140(θ x)	deg.
				140(θ y)	140(θ y)	140(θ y)	140(θ y)	140(θ y)	140(θ y)	

※Note: The dominant wave length (λ<sub>d</sub>) above is the setup value of the sorting machine.  
(Tolerance : λ<sub>d</sub>...±1nm)

## Luminous Intensity Rank

(Ta=25°C)

### Standard Chart (Unit: mcd)

Rank	I <sub>v</sub> (mcd)		VUB	VUG	VYBG	VYPY	VFY	VFA	VFV	VFR
	MIN.	MAX.	I <sub>F</sub> =10mA		I <sub>F</sub> =20mA					
A7	3.3	3.9								
A8	3.9	4.7								
A9	4.7	5.6								
AX	5.6	6.8			AX					
AY	6.8	8.2								
AZ	8.2	10.0								
B1	10.0	12.0								
B2	12.0	15.0								
B3	15.0	18.0	B3							
B4	18.0	22.0				B4				
B5	22.0	27.0			B5					
B6	27.0	33.0								
B7	33.0	39.0								
B8	39.0	47.0					B8	B8		B8
B9	47.0	56.0	B9	B9						
BX	56.0	68.0			BX					
BY	68.0	82.0							BY	
BZ	82.0	100.0								
C1	100.0	120.0						C1		
C2	120.0	150.0					C2			C2
C3	150.0	180.0		C3						
C4	180.0	220.0							C4	
C5	220.0	270.0								
C6	270.0	330.0								
C7	330.0	390.0								
C8	390.0	470.0								
C9	470.0	560.0								

※Limited width of luminous intensity rank is from Min.4 rank width.

## Color Tone Groups (λd)

(Ta=25°C)

(unit : nm)

Tolerance : +/-1nm

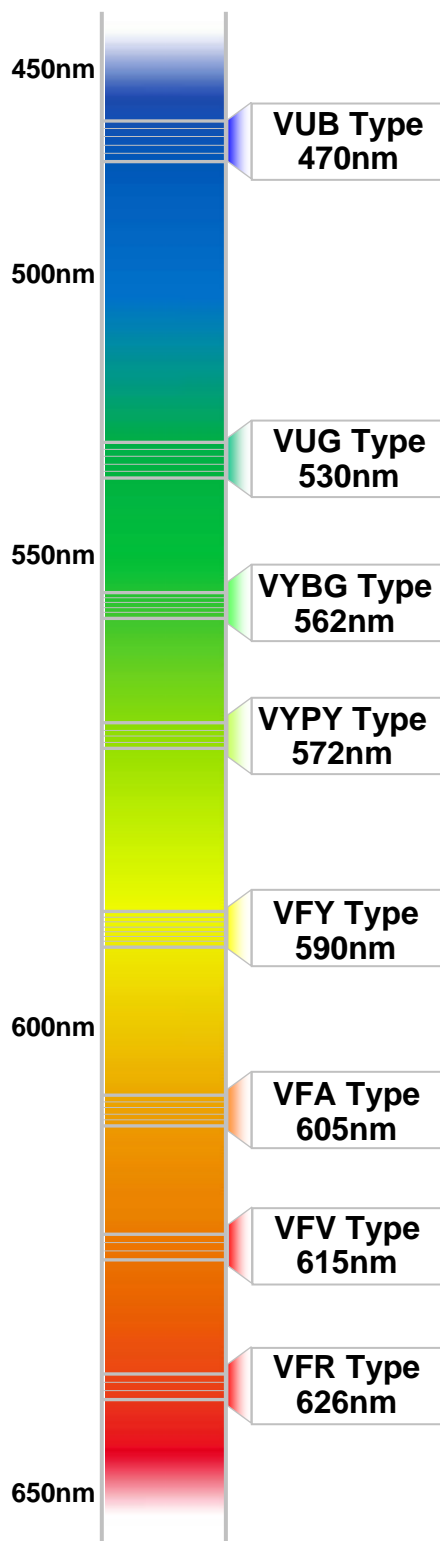

### VUB Type (I<sub>F</sub>=10mA)

	A	B	C	D
MIN.	460.0	464.0	468.0	472.0
MAX.	464.0	468.0	472.0	476.0

### VUG Type (I<sub>F</sub>=10mA)

	A	B	C	D
MIN.	515.0	520.0	525.0	530.0
MAX.	520.0	525.0	530.0	535.0

### VYBG Type (I<sub>F</sub>=20mA)

	B	C	D
MIN.	555.0	558.0	561.0
MAX.	558.0	561.0	564.0

### VYPY Type (I<sub>F</sub>=20mA)

	A	B	C
MIN.	567.0	570.0	573.0
MAX.	570.0	573.0	576.0

### VFY Type (I<sub>F</sub>=20mA)

	C	D	E	F
MIN.	583.0	586.0	589.0	592.0
MAX.	586.0	589.0	592.0	595.0

### VFA Type (I<sub>F</sub>=20mA)

	A	B	C	D
MIN.	597.0	600.0	603.0	606.0
MAX.	600.0	603.0	606.0	609.0

### VFV Type (I<sub>F</sub>=20mA)

	B	C	D
MIN.	613.0	616.0	619.0
MAX.	616.0	619.0	622.0

### VFR Type (I<sub>F</sub>=20mA)

	A	B	C
MIN.	620.0	626.0	632.0
MAX.	626.0	632.0	638.0

 ※Limited width of color tone rank is from Min.3 to Min.4 rank width.  
(It changes with product.)

## Characteristics Chart (VUB,VUG)

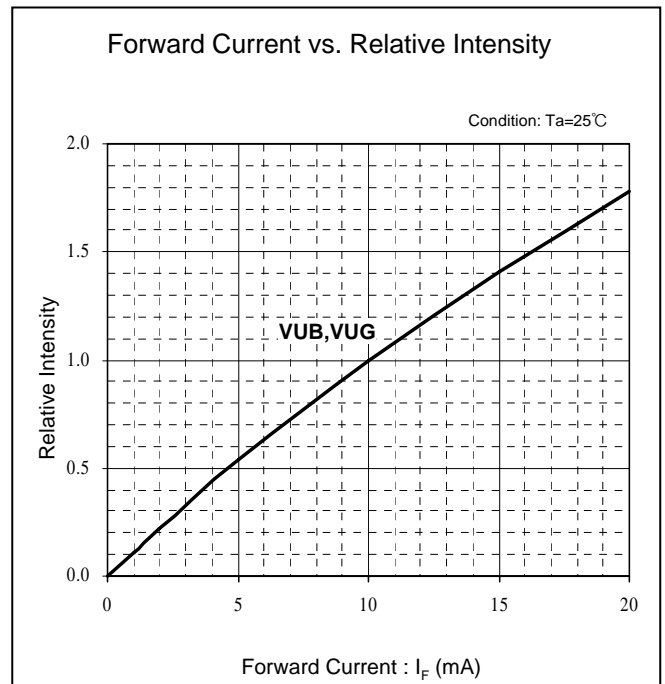
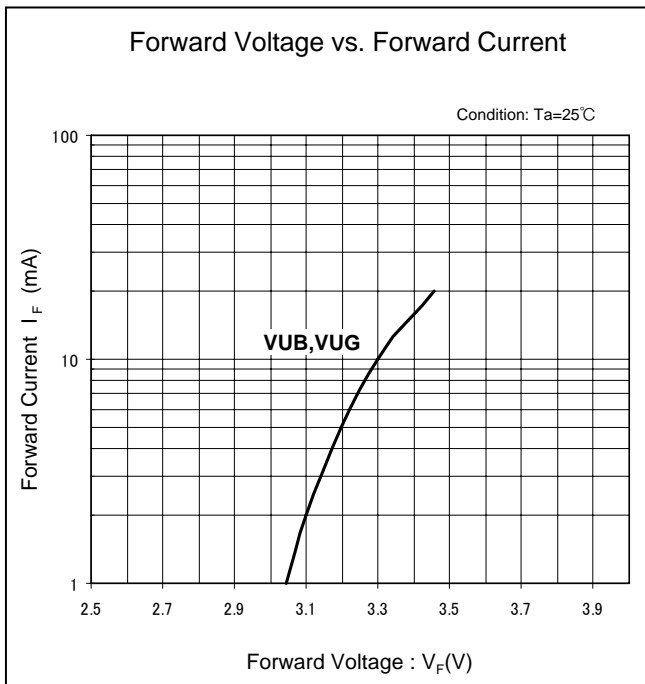
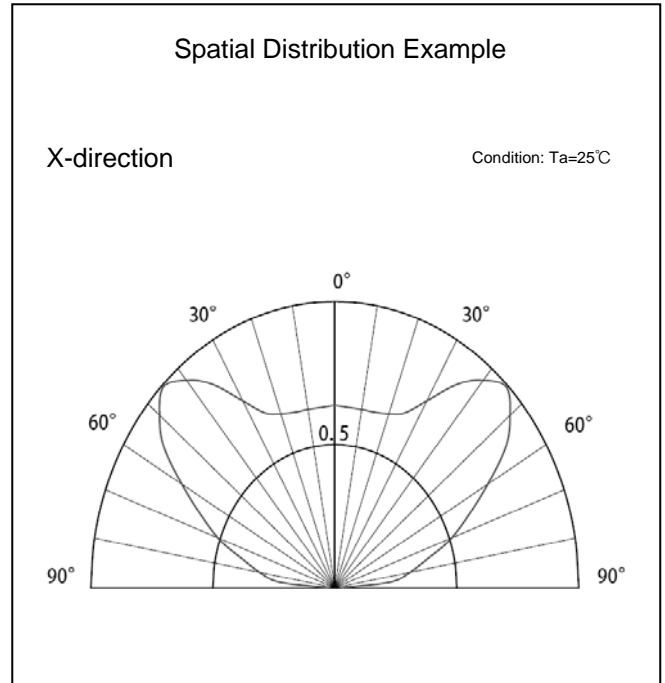
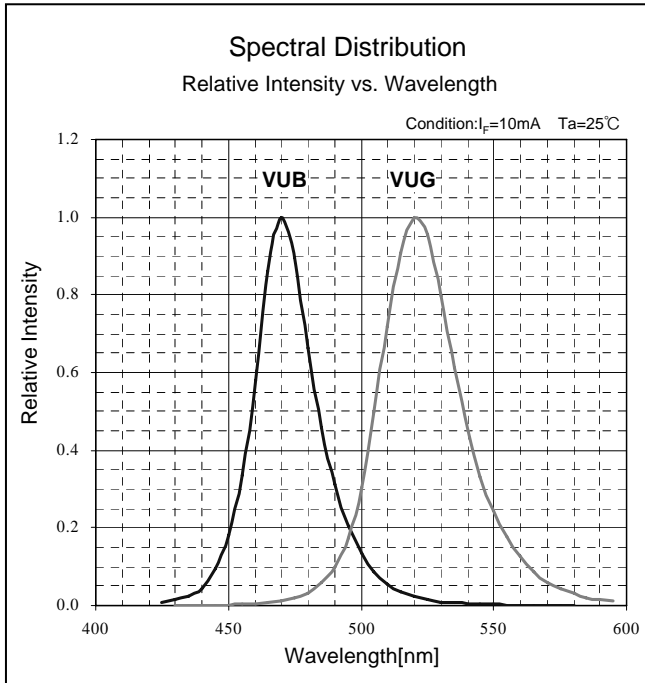

## Characteristics Chart (VUB, VUG)

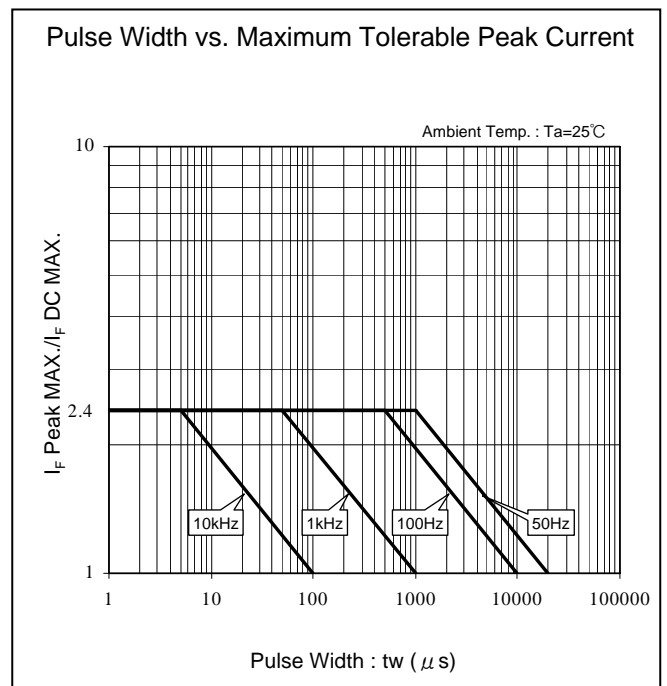
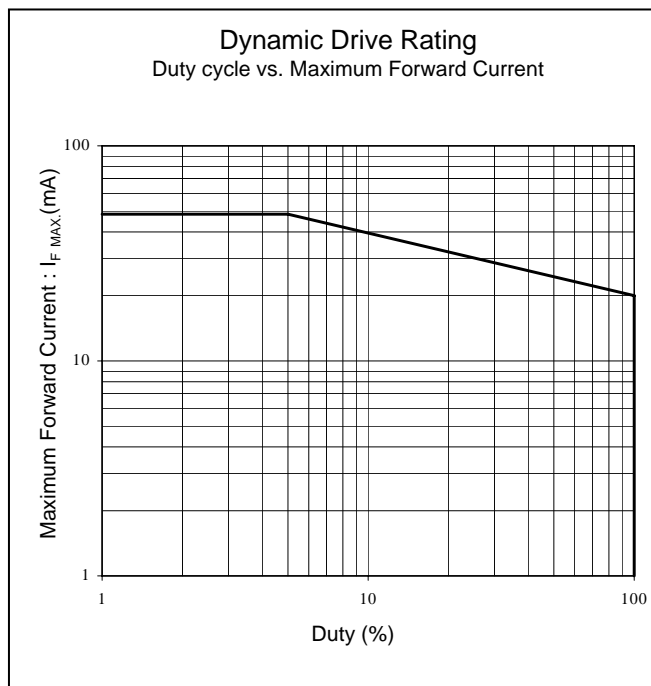
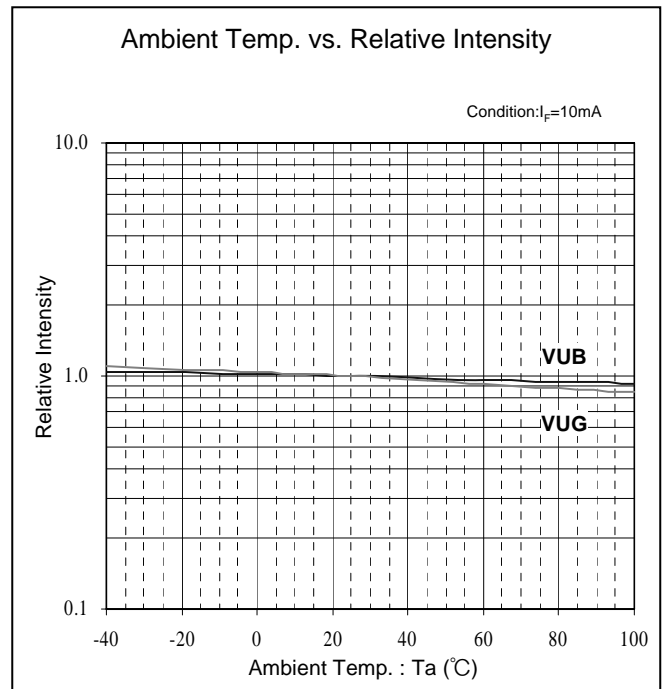
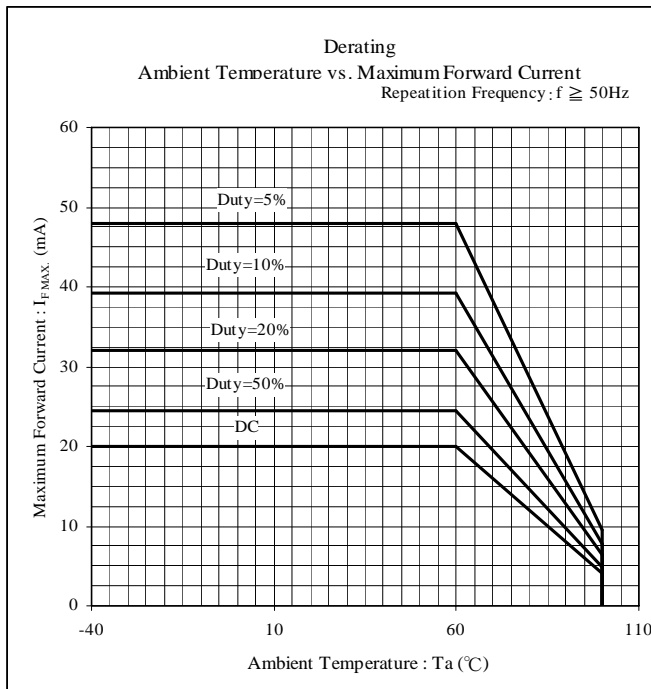



## Characteristics Chart(VYBG,VYPY)

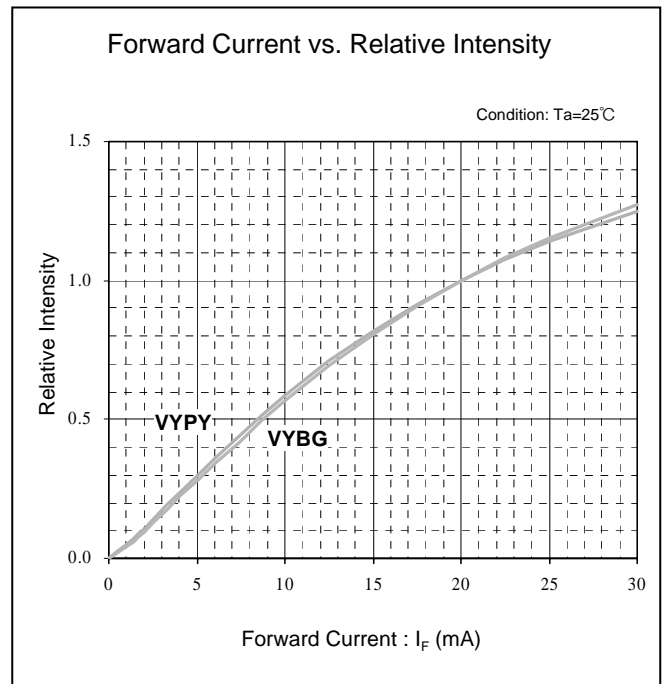
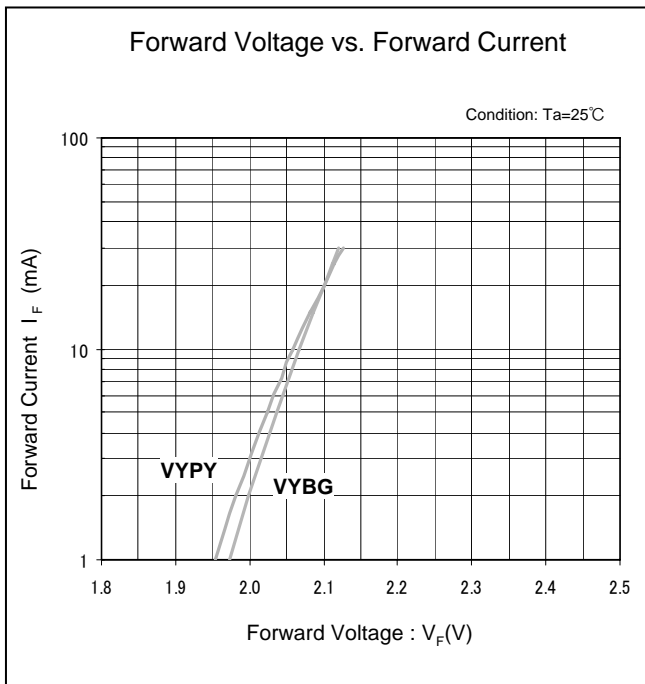
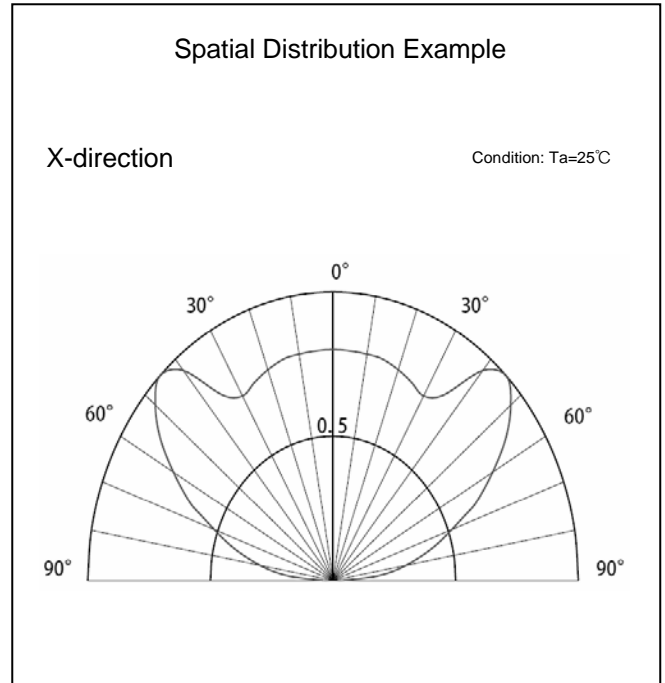
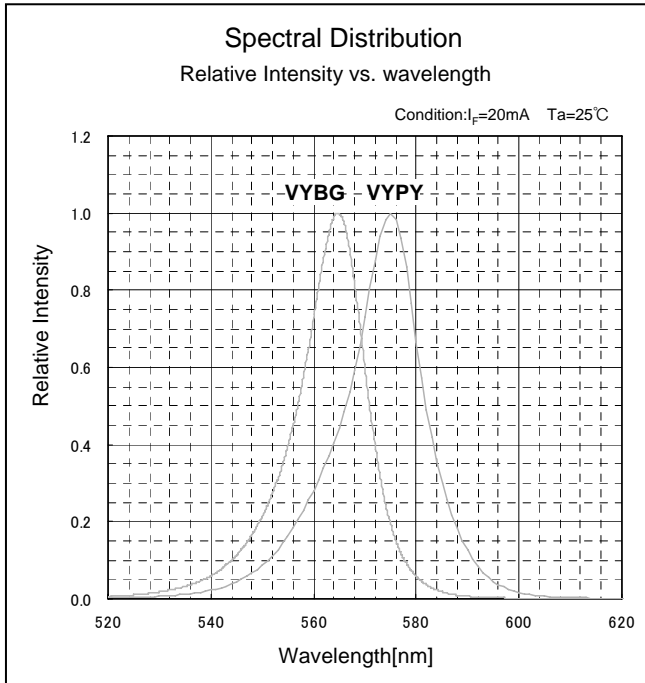

## Characteristics Chart (VYBG, VYPY)

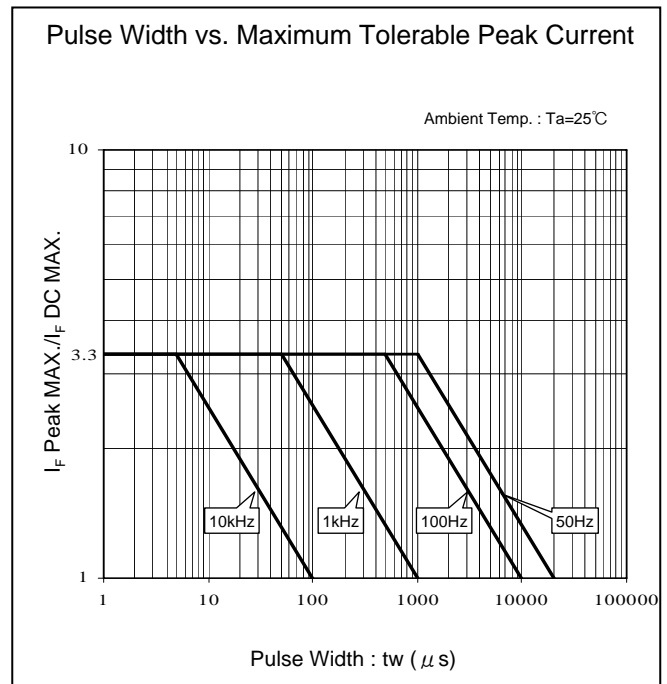
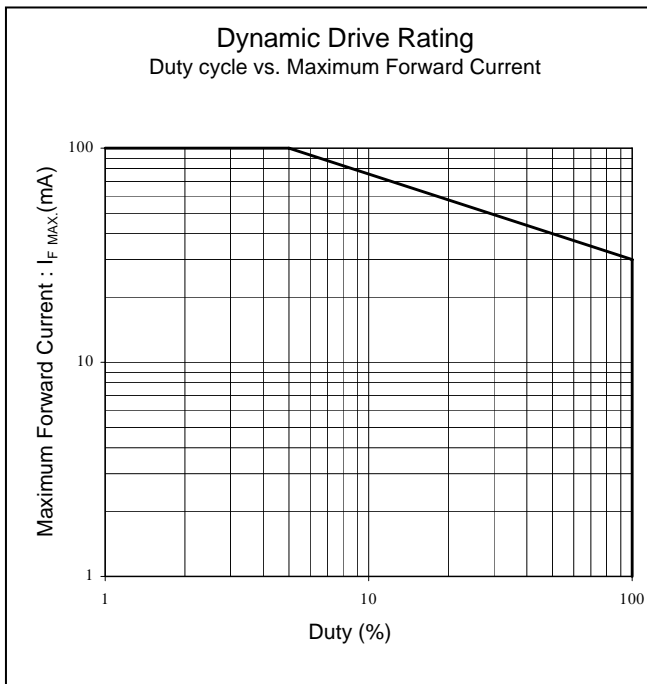
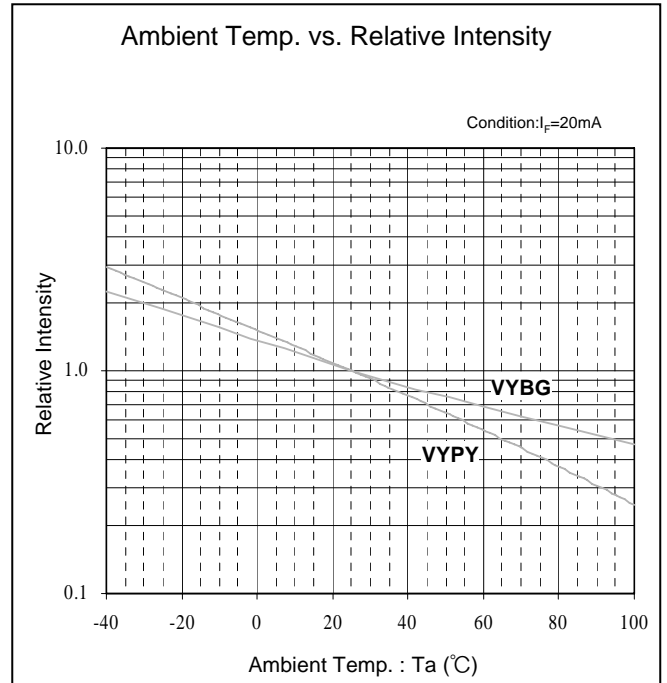
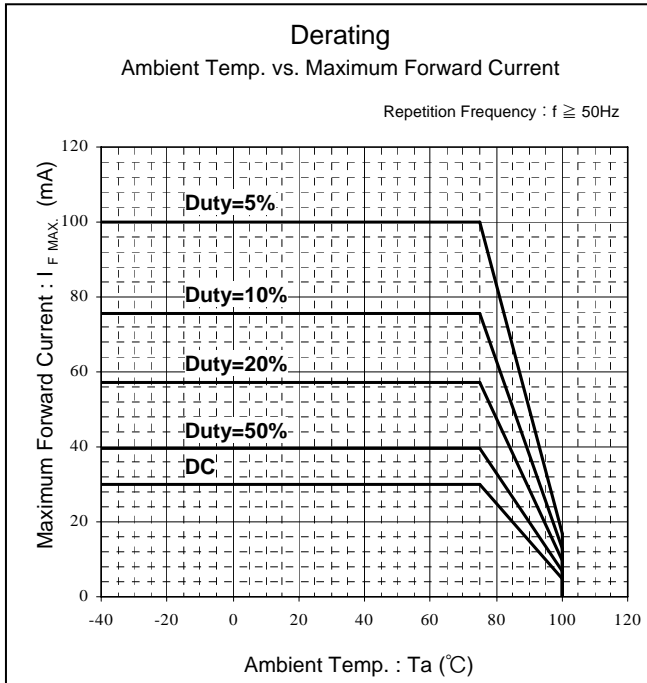

## Characteristics Chart (VFY, VFA, VFV, VFR)

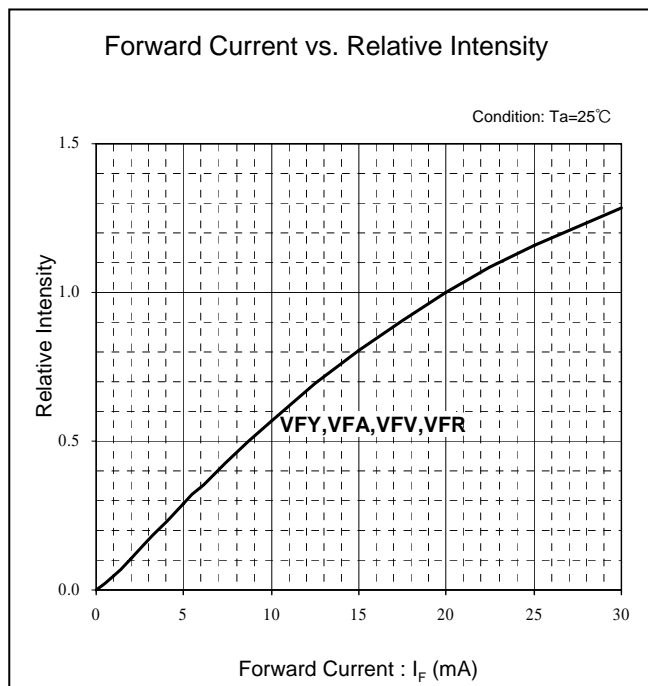
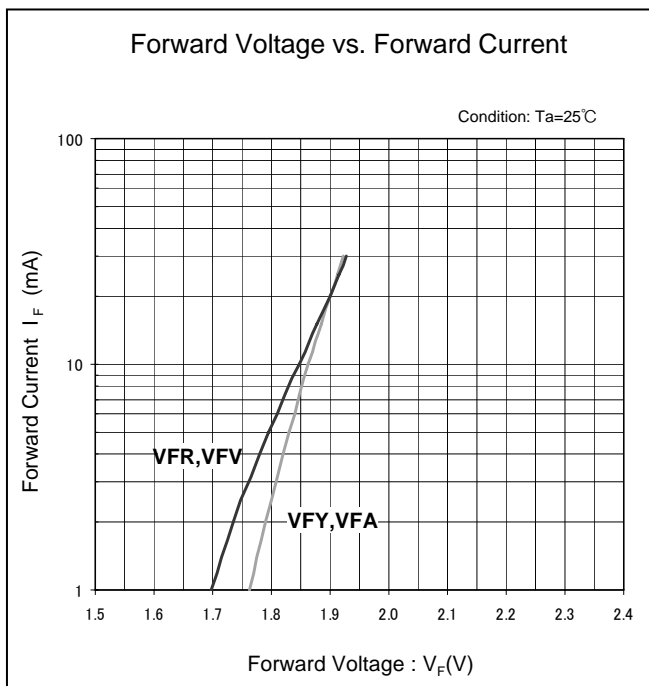
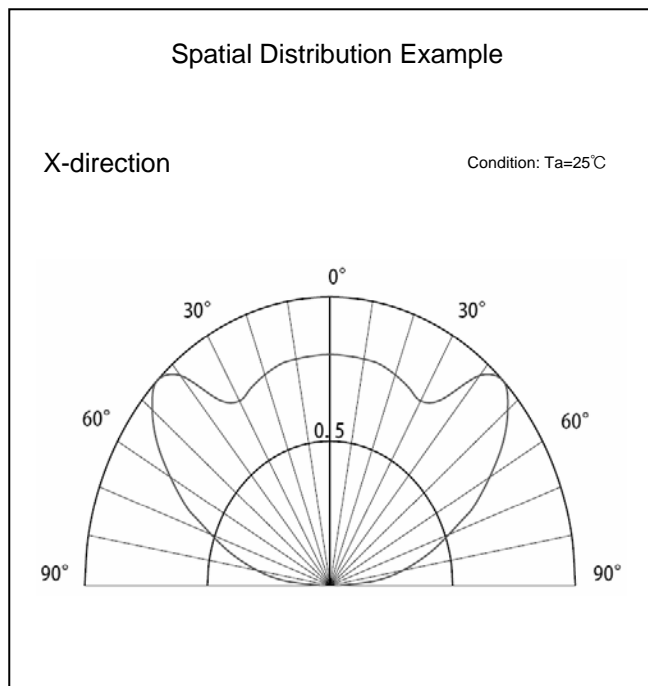
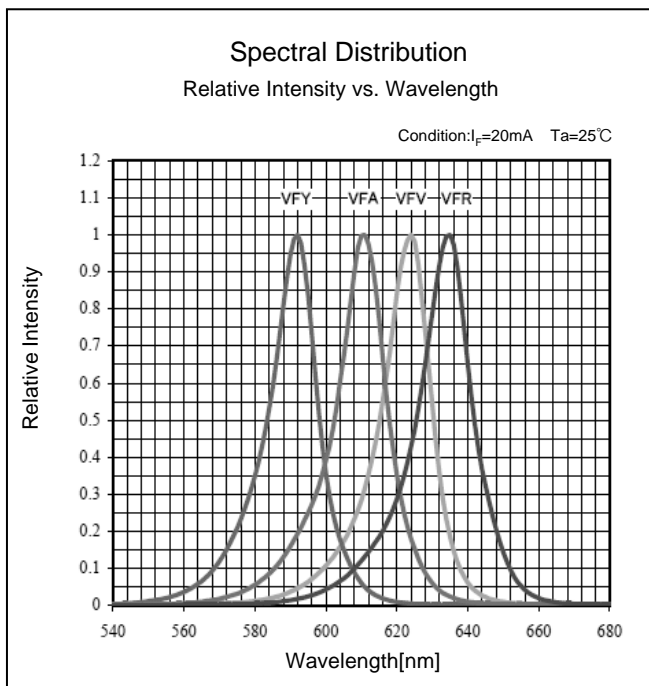

## Characteristics Chart (VFY, VFA, VFV, VFR)

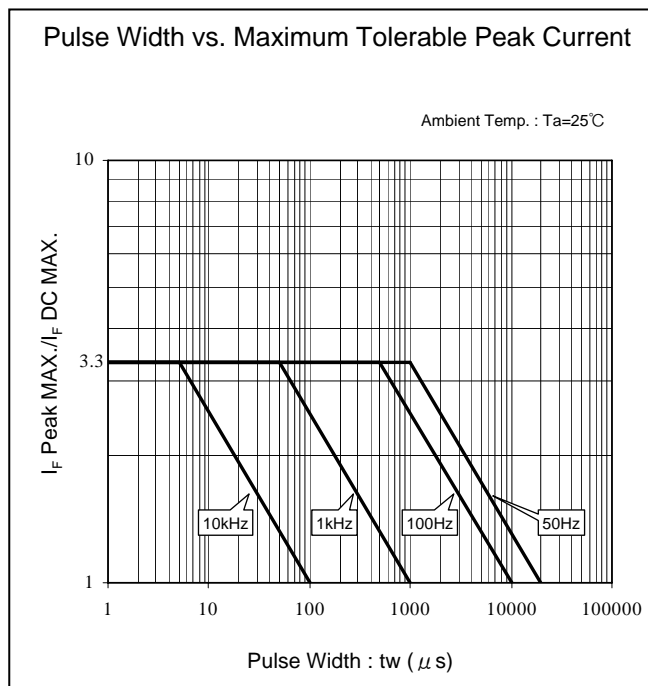
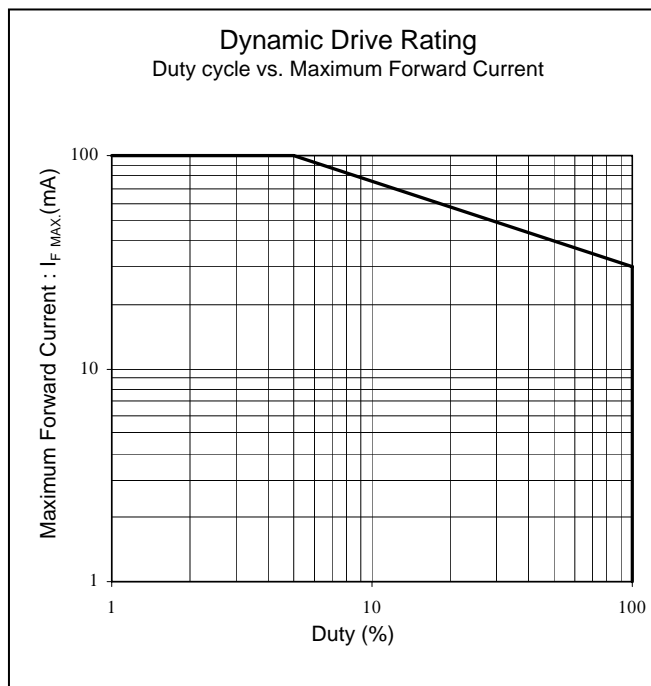
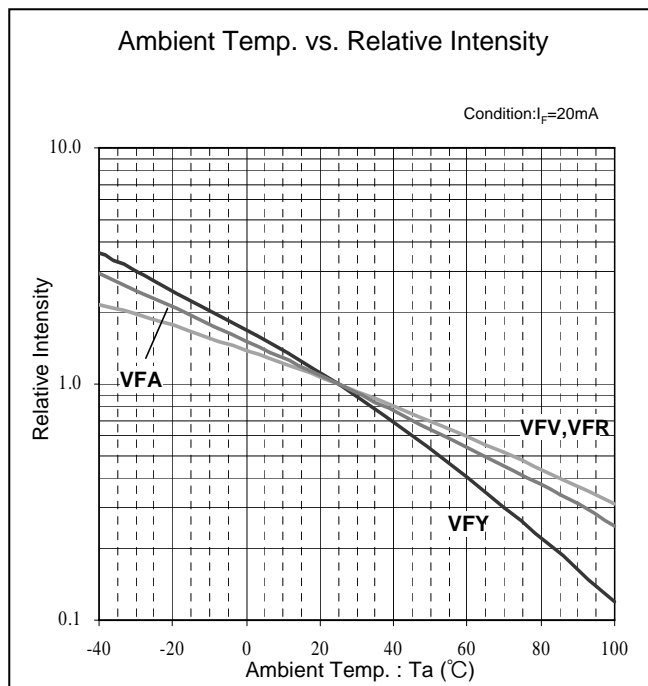
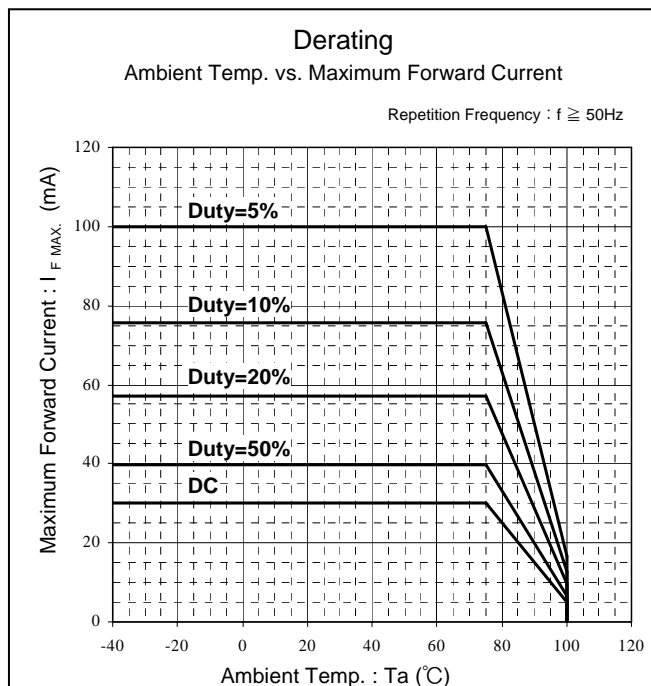

## Package Dimensions

(Unit: mm)

Weight: (7.80)mg

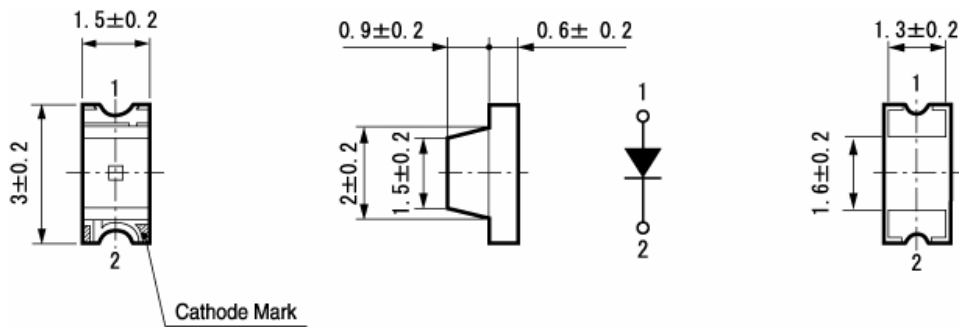

## Recommended Soldering Pattern

(Unit: mm)

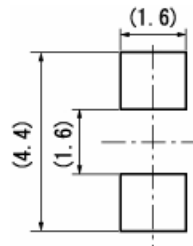

## Taping Specification

(Unit: mm)

Quantity : 2,500pcs/ reel (standard)

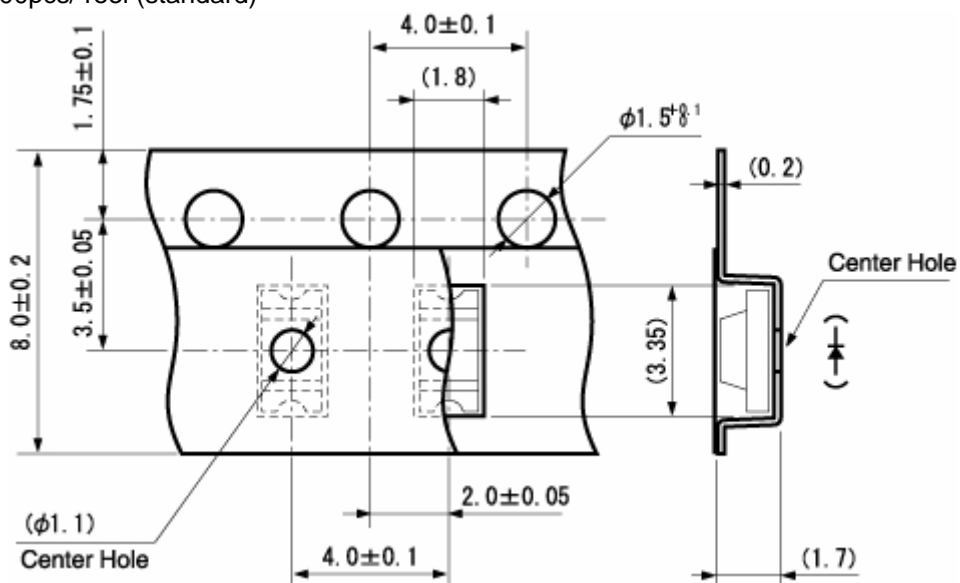

## Reflow Soldering Conditions

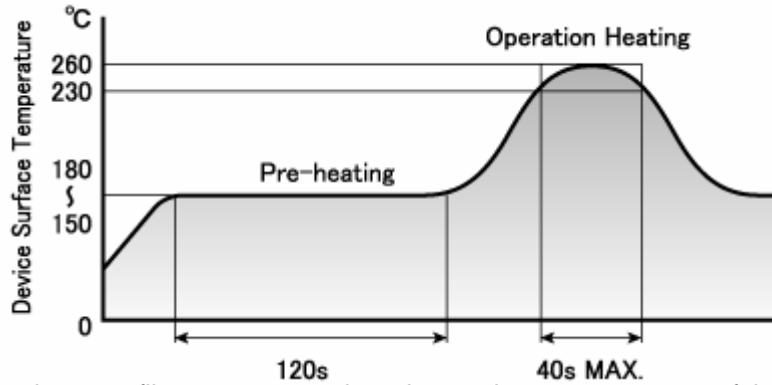

- 1) The above profile temperature gives the maximum temperature of the LED resin surface. Please set the temperature so as to avoid exceeding this range.
- 2) Total times of reflow soldering process shall be no more than 2 times. When the second reflow soldering process is performed, intervals between the first and second reflow should be short as possible (while allowing some time for the component to return to normal temperature after the first reflow) in order to prevent the LED from absorbing moisture.
- 3) Temperature fluctuation to the LED during the pre-heating process shall be minimized. (6°C maximum)

## Manual Soldering Conditions

Iron tip temp.	350 °C	(MAX.)
Soldering time and frequency	3 s	(MAX.)
	1 time	(MAX.)

## Reliability Testing Result

Reliability Testing Result	Applicable Standard	Testing Conditions	Duration	Failure
Room Temp. Operating Life	EAJED-4701/100(101)	Ta = 25°C, I <sub>F</sub> = Maximum Rated Current	1,000 h	0/20
High Temp. Operating Life	EAJED-4701/100(101)	Ta = Maximum Rated Operating Temperature, I <sub>F</sub> = Derating Value	1,000 h	0/20
Low Temp. Operating Life	EAJED-4701/100(101)	Ta = -40°C, I <sub>F</sub> = Maximum Rated Current	1,000 h	0/20
Wet High Temp. Operating Life	EAJED-4701/100(102)	Ta = 60°C, 90%, I <sub>F</sub> = Maximum Rated Current	1,000 h	0/20
Wet High Temp. Storage Life	EAJED-4701/100(103)	Ta = 60°C, 90%	1,000 h	0/20
Thermal Shock	EAJED-4701/100(105)	Ta = -40°C ~ Maximum Rated Storage Temperature (each 15min.)	1,000 cycles	0/20
Thermal Shock Operating	EAJED-4701/100(105)	Ta = -40°C(off) ~ 85°C (I <sub>F</sub> = Derating Value on), (each 15min.)	1,000 cycles	0/20
High Temp. Storage Life	EAJED-4701/200(201)	Ta = Maximum Rated Storage Temperature	1,000 h	0/20
Low Temp. Storage Life	EAJED-4701/200(202)	Ta = Minimum Rated Storage Temperature	1,000 h	0/20
Cycled Temp. Humidity Life	EAJED-4701/200(203)	Ta = -30°C(2h) ~ 80°C, 95%(2h), 8h/cycle, I <sub>F</sub> = Derating Value, 5min on-off	30 cycles	0/20
Resistance to Reflow Soldering	EAJED-4701/300(301)	Moisture Soak : 30°C, 70%, 72h Preheat : 150 ~ 180°C(120s Max.) Soldering Temp. : 260°C(5s)	Twice	0/20
Electric Static Discharge (ESD) <sup>※1</sup>	EAJED-4701/300(304)	C = 100pF, R <sub>2</sub> = 1.5KΩ, ±2,000V	once each polarity	0/10
Vibration, Variable Frequency	EAJED-4701/400(403)	98.1m/s <sup>2</sup> (10G), 100 ~ 2KHz, 20min, XYZ each direction	2 h	0/10

※1 Reference test

## Failure Criteria

Items	Symbols	Conditions	Failure criteria
Luminous Intensity	I <sub>v</sub>	I <sub>F</sub> Value of each product Luminous Intensity	Testing Min. Value < Spec. Min. Value x 0.5
Forward Voltage	V <sub>F</sub>	I <sub>F</sub> Value of each product Forward Voltage	Testing Max. Value ≥ Spec. Max. Value x 1.2
Reverse Current	I <sub>R</sub>	V <sub>R</sub> = Maximum Rated Reverse Voltage V	Testing Max. Value ≥ Spec. Max. Value x 2.5
Cosmetic Appearance	-	-	Occurrence of notable decoloration, deformation and cracking

## Special Notice to Customers Using the Products and Technical Information Shown in This Data Sheet

- 1) The technical information shown in the data sheets are limited to the typical characteristics and circuit examples of the referenced products. It does not constitute the warranting of industrial property nor the granting of any license.
- 2) For the purpose of product improvement, the specifications, characteristics and technical data described in the data sheets are subject to change without prior notice. Therefore it is recommended that the most updated specifications be used in your design.
- 3) When using the products described in the data sheets, please adhere to the maximum ratings for operating voltage, heat dissipation characteristics, and other precautions for use. We are not responsible for any damage which may occur if these specifications are exceeded.
- 4) The products that have been described to this catalog are manufactured so that they will be used for the electrical instrument of the benchmark (OA equipment, telecommunications equipment, AV machine, home appliance and measuring instrument).  
The application of aircrafts, space borne application, transportation equipment, medical equipment and nuclear power control equipment, etc. needs a high reliability and safety, and the breakdown and the operation might influence the life or the human body. Please consult us beforehand if you plan to use our product for the usages of aircrafts, space borne application, transportation equipment, medical equipment and nuclear power control equipment, etc. except OA equipment, telecommunications equipment, AV machine, home appliance and measuring instrument.
- 5) In order to export the products or technologies described in this data sheet which are under the "Foreign Exchange and Foreign Trade Control Law," it is necessary to first obtain an export permit from the Japanese government.
- 6) No part of this data sheet may be reprinted or reproduced without prior written permission from Stanley Electric Co., Ltd.
- 7) The most updated edition of this data sheet can be obtained from the address below:  
<http://www.stanley-components.com>