



**Pb-free
HEAT**



U□1112H Series

Single Color Ultra High Brightness Type

Features

| | |
|-------------------------|--|
| Package | 2125(h =0.8mm) Type, Milky White resin |
| Product features | <ul style="list-style-type: none"> • Outer Dimension 2.0 x 1.25 x 0.8mm (L x W x H) • Temperature range Storage Temperature : -40 ~100 Operating Temperature : -40 ~85 • Lead-free soldering compatible • RoHS compliant |
| Dominant wavelength | Blue : 470nm(UB) Green : 530nm(UG) Yellow : 590nm(UY) Red : 630nm(UR) |
| Half Intensity Angle | UB,UG :θx = 140 deg., θy = 165 deg. UY,UR :θx = 150 deg., θy = 140 deg. |
| Die materials | UB,UG : InGaN, UY,UR : AlGaInP |
| Rank grouping parameter | Sorted by luminous intensity and wavelength per rank taping |
| Assembly method | Auto pick & place machine (Auto Mounter) |
| Soldering methods | Reflow soldering and manual soldering |
| Taping and reel | 4,000pcs per reel in a 8mm width tape. (Standard) Reel diameter:φ180mm |
| ESD | 1kV (HBM) |

Recommended Applications

Communication Machine, Electric Household Appliances, OA/FA, Other General Applications

Color and Luminous Intensity

(Ta=25)

| Part No. | Material | Emitted Color | Lens Color | Dominant Wavelength | | Luminous Intensity | | |
|----------|----------|---------------|-------------|---------------------|----------------|--------------------|------|----------------|
| | | | | λd (nm) | | Iv (mcd) | | |
| | | | | TYP. | I _F | MIN. | TYP. | I _F |
| UB1112H | InGaN | Blue | Milky White | 470 | 10 | 17 | 34 | 10 |
| UG1112H | InGaN | Green | | 530 | 10 | 96 | 160 | 10 |
| UY1112H | AlGaInP | Yellow | | 590 | 20 | 50 | 100 | 20 |
| UR1112H | AlGaInP | Red | | 630 | 20 | 50 | 100 | 20 |

Absolute Maximum Ratings

(Ta=25)

| Item | Symbol | Absolute Maximum Ratings | | | | Unit |
|---------------------------------|------------------|--------------------------|------|------|------|-------|
| | | UB | UG | UY | UR | |
| Power Dissipation | P_d | 78 | 78 | 87 | 87 | mW |
| Forward Current | I_F | 20 | 20 | 30 | 30 | mA |
| Pulse Forward Current ※1 | I_{FRM} | 48 | 48 | 100 | 100 | mA |
| Derating (Ta=25°C or higher) | ΔI_F | 0.28 | 0.28 | 0.43 | 0.43 | mA/°C |
| | ΔI_{FRM} | 0.69 | 0.69 | 1 | 1 | mA/°C |
| Reverse Voltage | V_R | 5 | 5 | 5 | 5 | V |
| Operating Temperature | T_{opr} | -40~+85 | | | | °C |
| Storage Temperature | T_{stg} | -40~+100 | | | | °C |

 1 I_{FRM} Measurement condition :tw 1ms., Duty 1/20 (UY,UR : 1/10).

Electro-Optical Characteristics(UB,UG)

(Ta=25)

| Item | Conditions | Symbol | Characteristics | | Unit | |
|--------------------------|----------------------|----------------|-----------------|----------|----------|------|
| | | | UB | UG | | |
| Forward Voltage | I _F =10mA | V _F | TYP. | 3.4 | 3.4 | V |
| | | | MAX. | 3.9 | 3.9 | |
| Reverse Current | V _R =5V | I _R | MAX. | 100 | 100 | μ A |
| Peak Wavelength | I _F =10mA | λ _p | TYP. | 465 | 522 | nm |
| Dominant Wavelength | I _F =10mA | λ _d | TYP. | 470 | 530 | nm |
| Spectral Line Half Width | I _F =10mA | Δλ | TYP. | 26 | 35 | nm |
| Half Intensity Angle | I _F =10mA | 2θ 1/2 | TYP. | 140(θ x) | 140(θ x) | deg. |
| | | | | 165(θ y) | 165(θ y) | |

Electro-Optical Characteristics(UY,UR)

(Ta=25)

| Item | Conditions | Symbol | Characteristics | | Unit | |
|--------------------------|----------------------|----------------|-----------------|----------|----------|------|
| | | | UY | UR | | |
| Forward Voltage | I _F =20mA | V _F | TYP. | 2.2 | 2.2 | V |
| | | | MAX. | 2.8 | 2.8 | |
| Reverse Current | V _R =5V | I _R | MAX. | 100 | 100 | μ A |
| Peak Wavelength | I _F =20mA | λ _p | TYP. | 592 | 641 | nm |
| Dominant Wavelength | I _F =20mA | λ _d | TYP. | 590 | 630 | nm |
| Spectral Line Half Width | I _F =20mA | Δλ | TYP. | 18 | 18 | nm |
| Half Intensity Angle | I _F =20mA | 2θ 1/2 | TYP. | 150(θ x) | 150(θ x) | deg. |
| | | | | 140(θ y) | 140(θ y) | |

Luminous Intensity Rank

(Ta=25)

| Rank | I _v (mcd) | | | | | | | |
|------|----------------------|------|----------------------|------|----------------------|------|----------------------|------|
| | UB | | UG | | UY | | UR | |
| | I _F =10mA | | I _F =10mA | | I _F =20mA | | I _F =20mA | |
| | MIN. | MAX. | MIN. | MAX. | MIN. | MAX. | MIN. | MAX. |
| A | / | | / | | 50 | 100 | 50 | 100 |
| B | | | | | 70 | 140 | 70 | 140 |
| C | | | | | 96 | 136 | 100 | 200 |
| D | 17 | 24 | 112 | 160 | 140 | 280 | 140 | 280 |
| E | 20 | 28 | 136 | 192 | 200 | 400 | 200 | 400 |
| F | 24 | 34 | 160 | 224 | 280 | - | 280 | - |
| G | 28 | 40 | 192 | 272 | / | | / | |
| H | 34 | 48 | 224 | 320 | | | | |
| J | 40 | 56 | 272 | - | | | | |
| K | 48 | - | / | | | | | |

Please contact our sales staff concerning rank designation.

Color Tone Groups (λd)

(Ta=25)

| Rank | Dominant Wavelength λd (nm) | | | |
|------|--------------------------------------|------|----------------------|------|
| | UY | | UR | |
| | I _F =20mA | | I _F =20mA | |
| | MIN. | MAX. | MIN. | MAX. |
| A | 580 | 585 | 620 | 630 |
| B | 584 | 589 | 628 | 638 |
| C | 588 | 593 | / | |
| D | 592 | 597 | | |
| E | 596 | 601 | | |

Please contact our sales staff concerning rank designation.

Technical Data(UB)

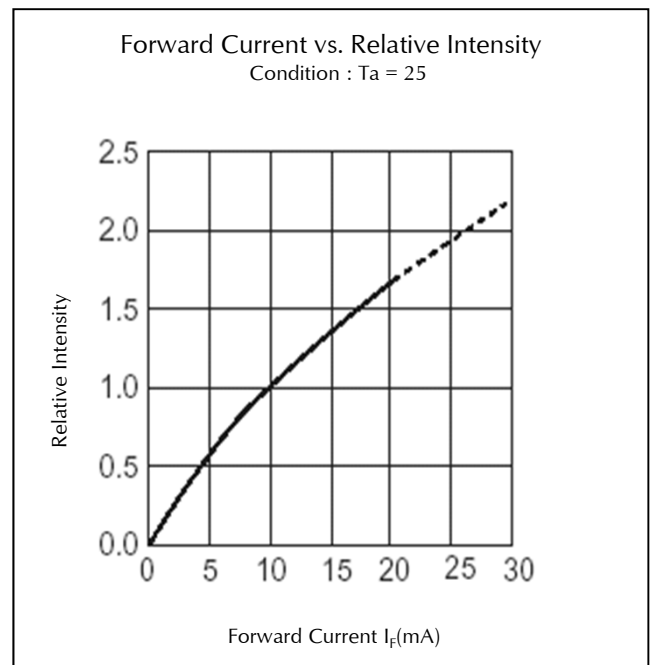
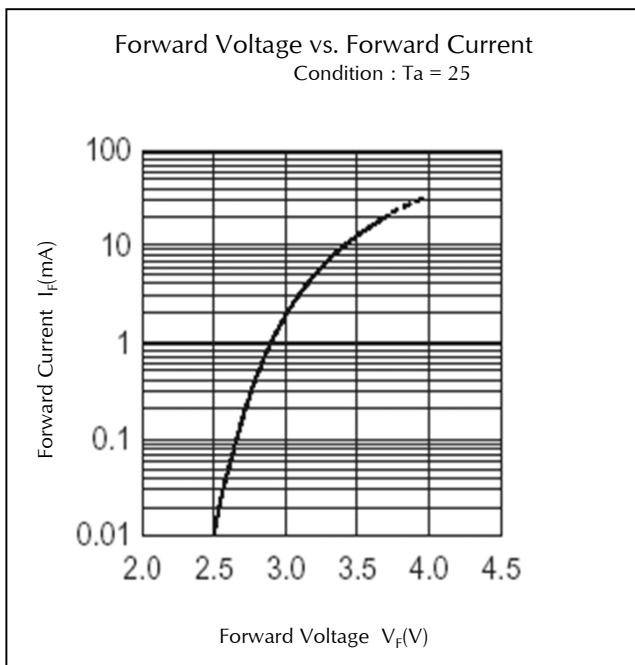
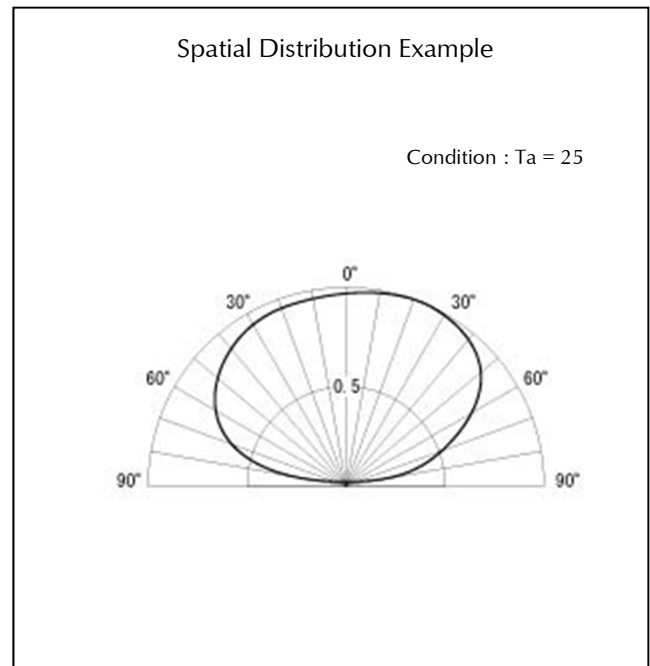
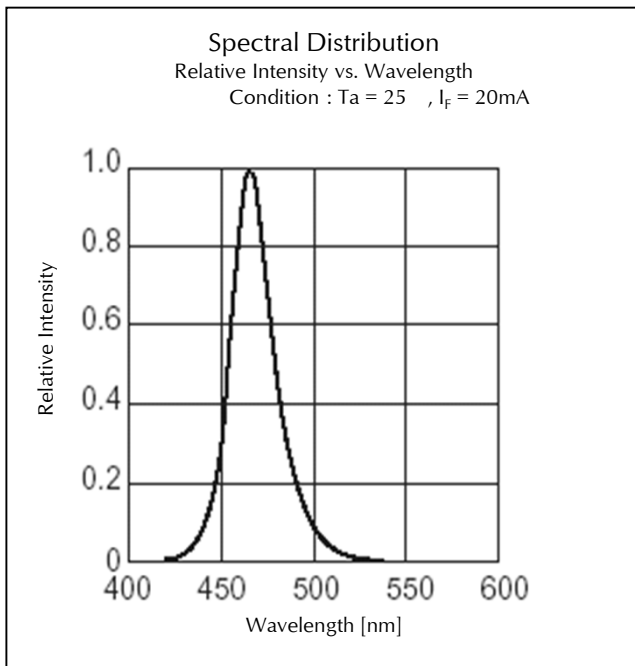

Technical Data(UB)

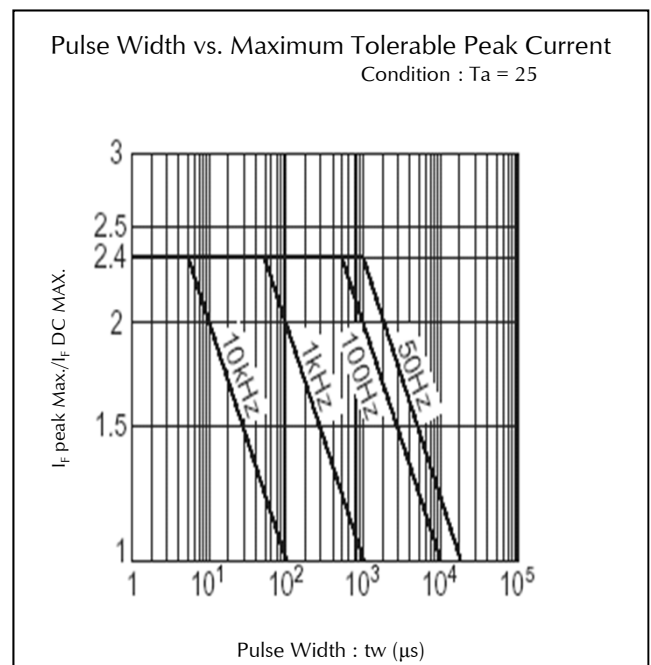
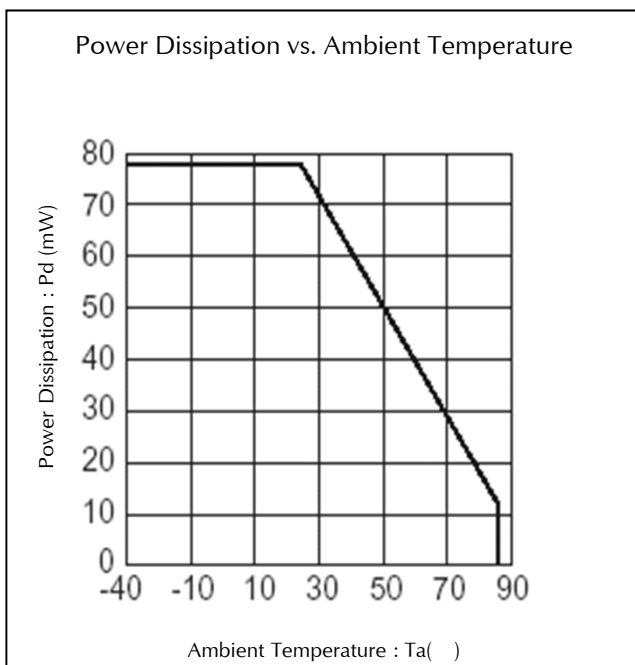
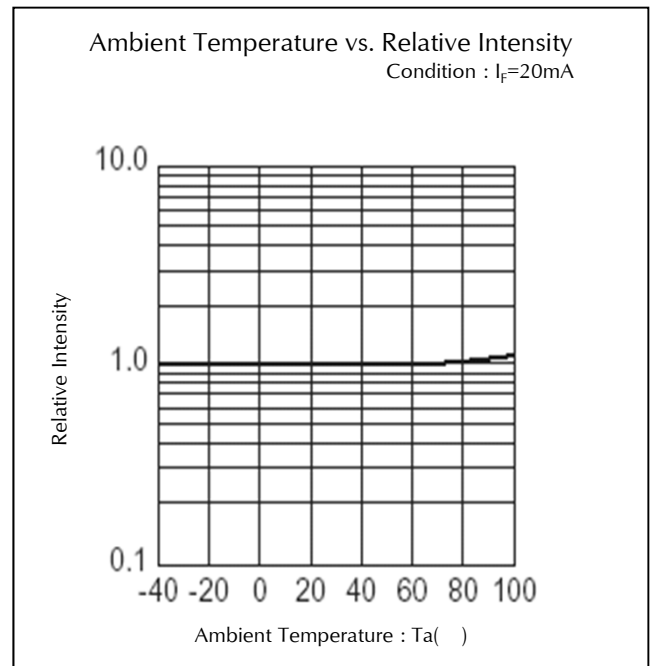
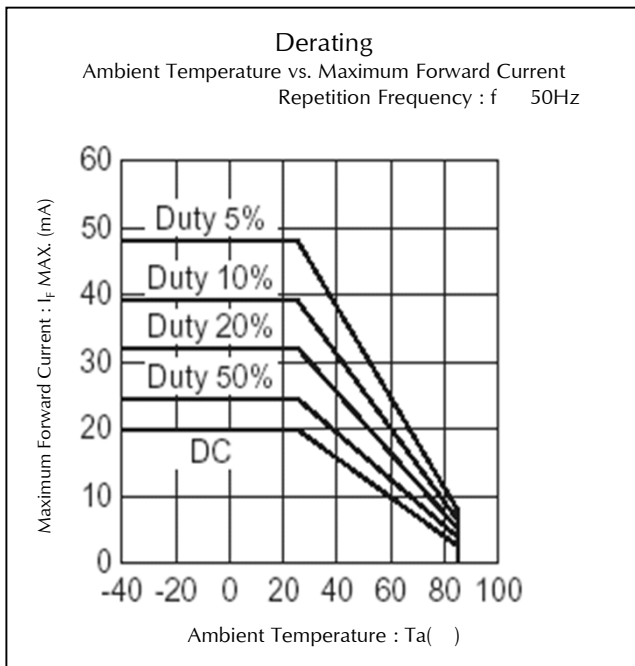

Technical Data(UG)

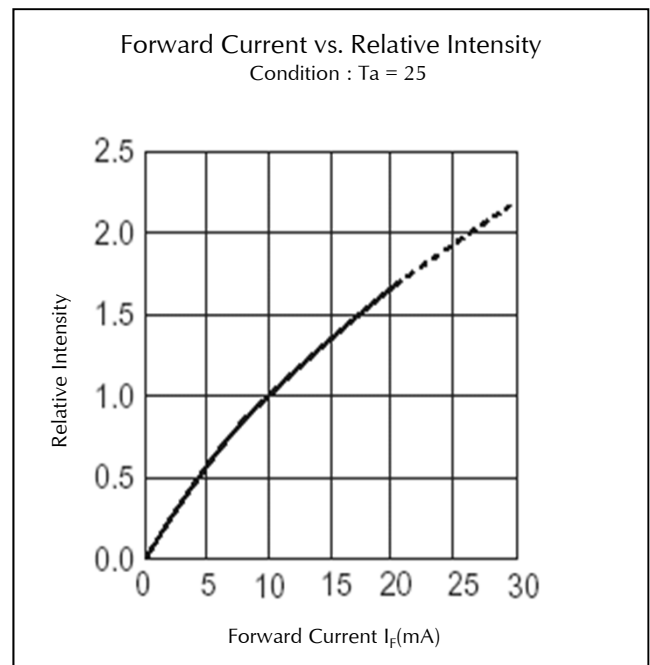
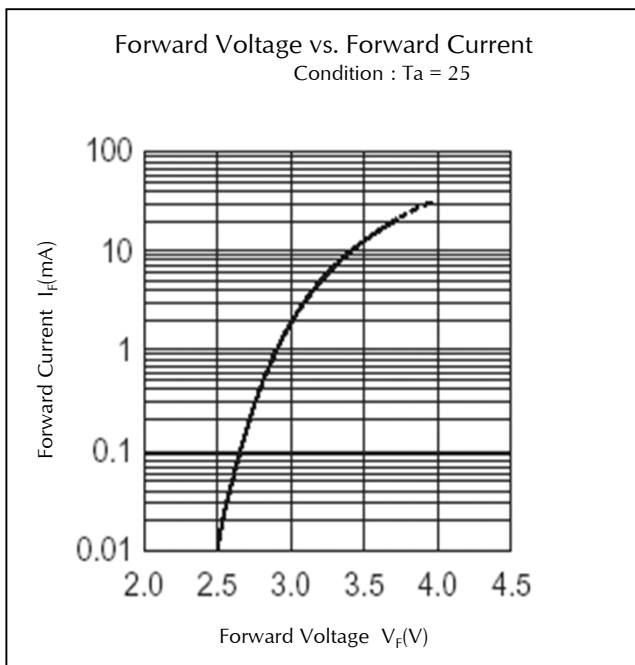
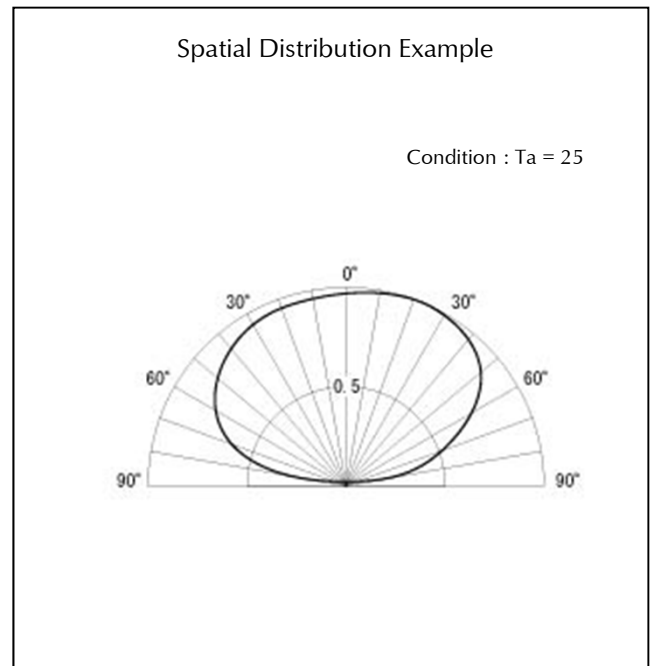
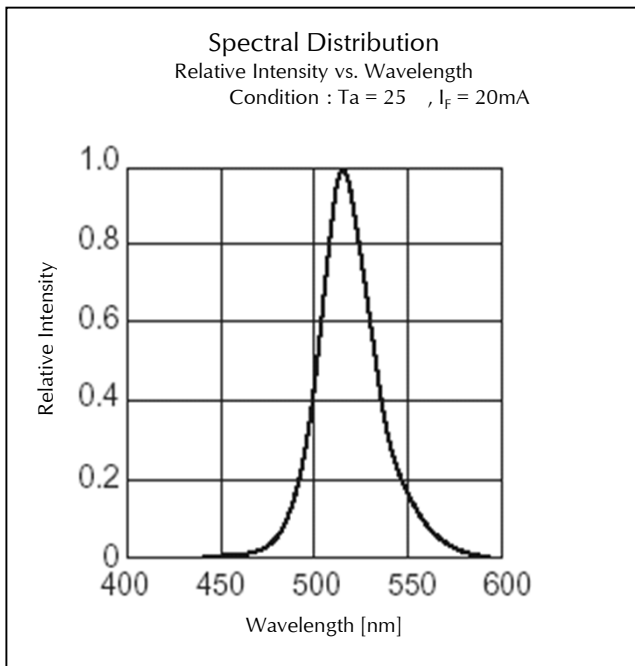

Technical Data(UG)

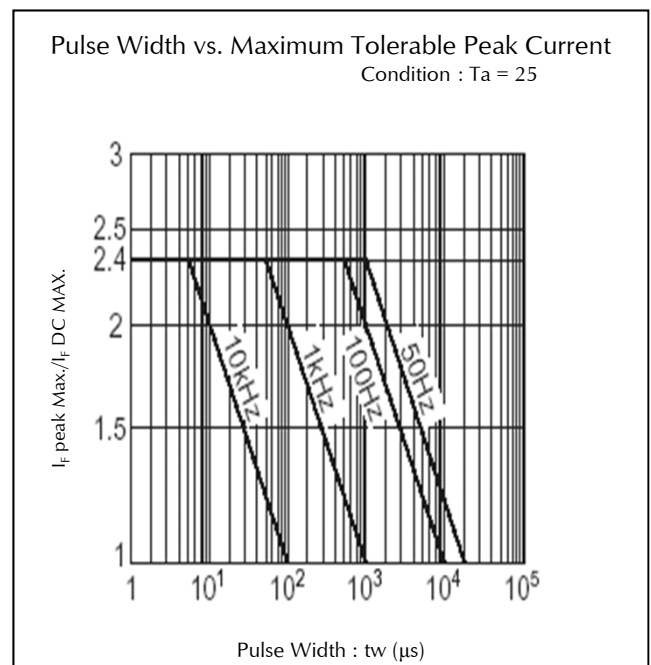
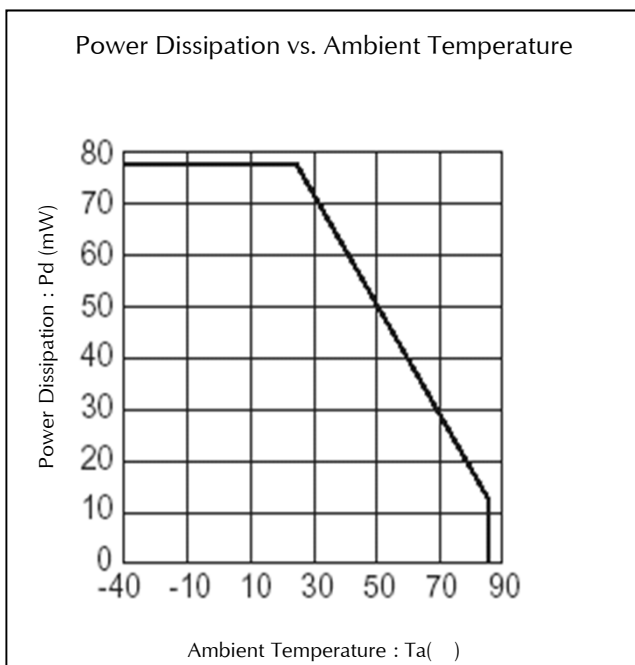
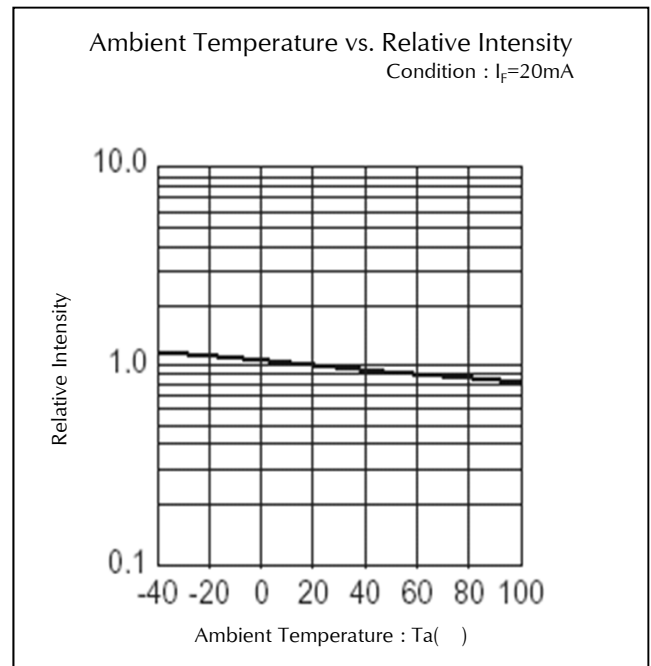
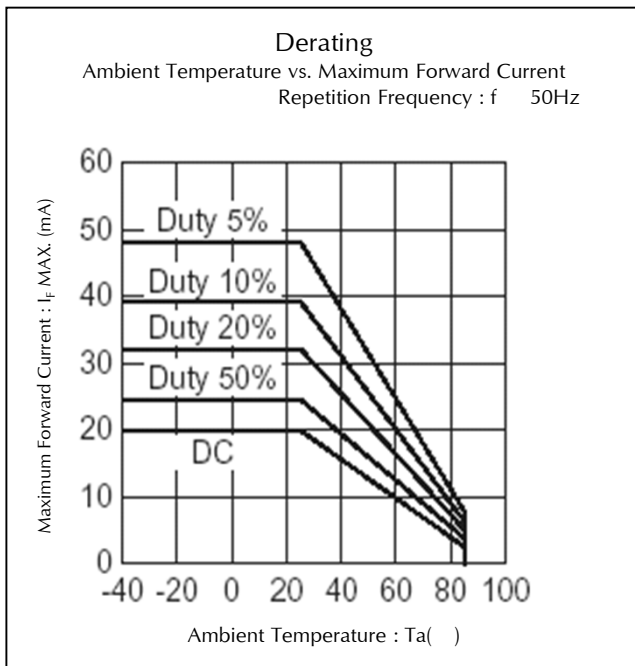

Technical Data(UY)

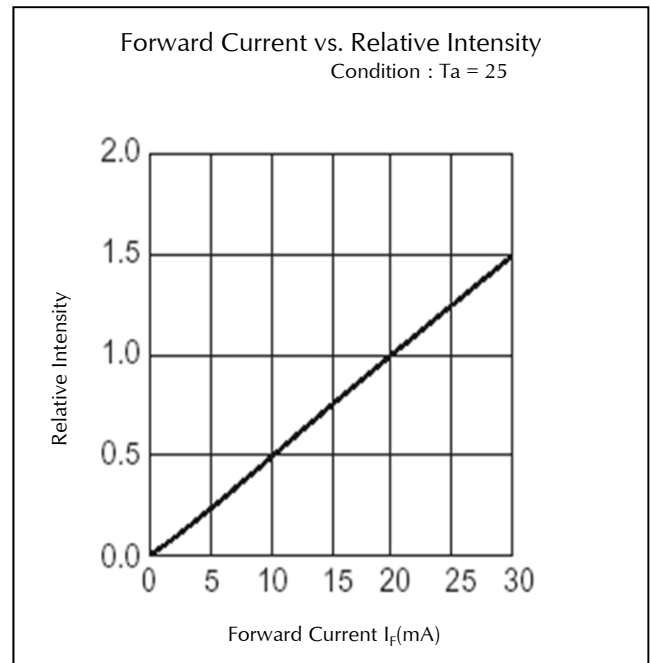
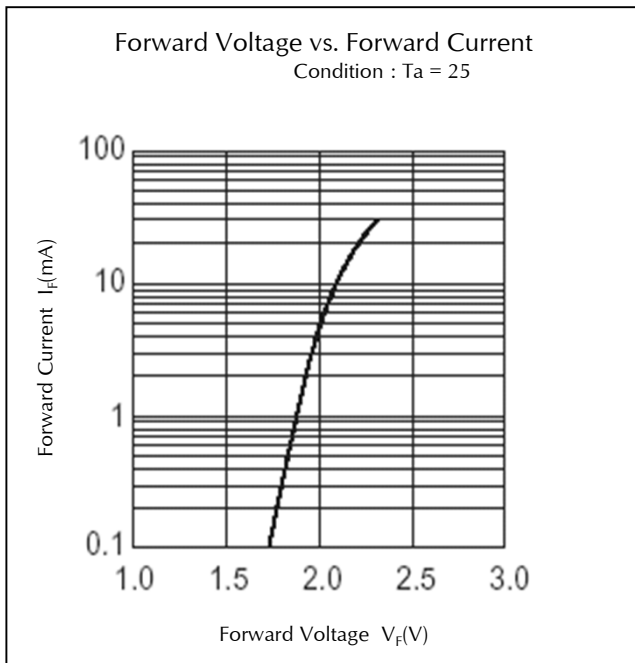
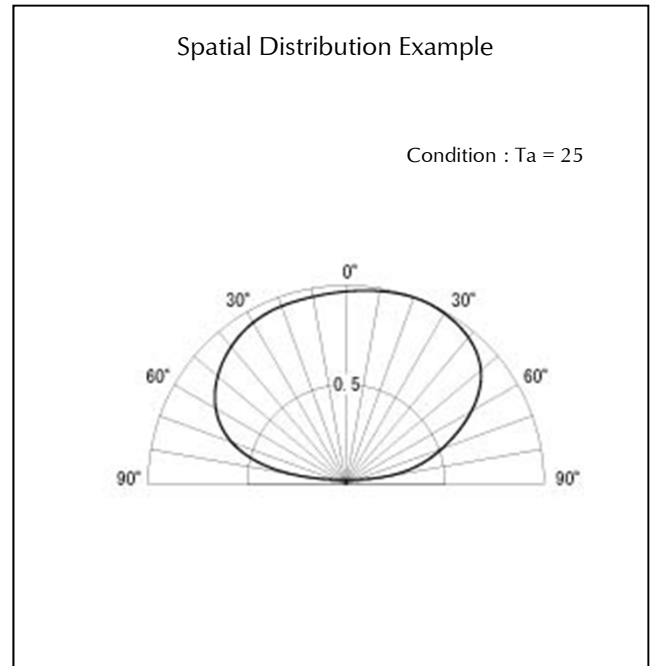
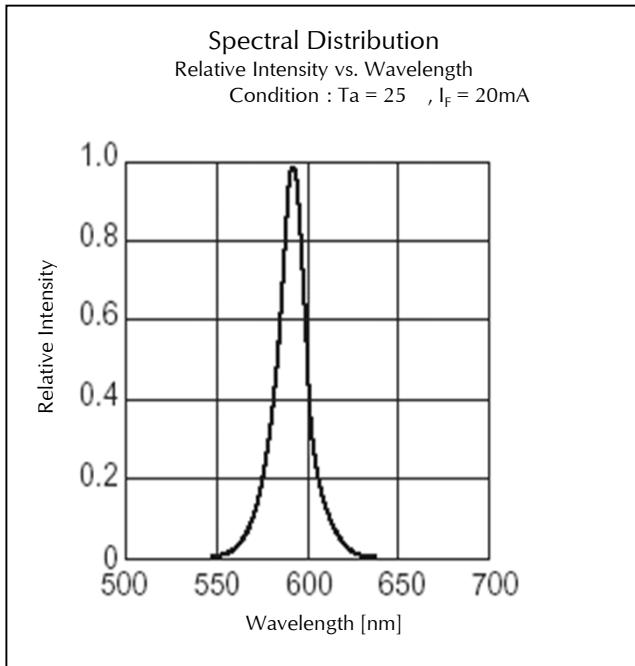

Technical Data(UY)

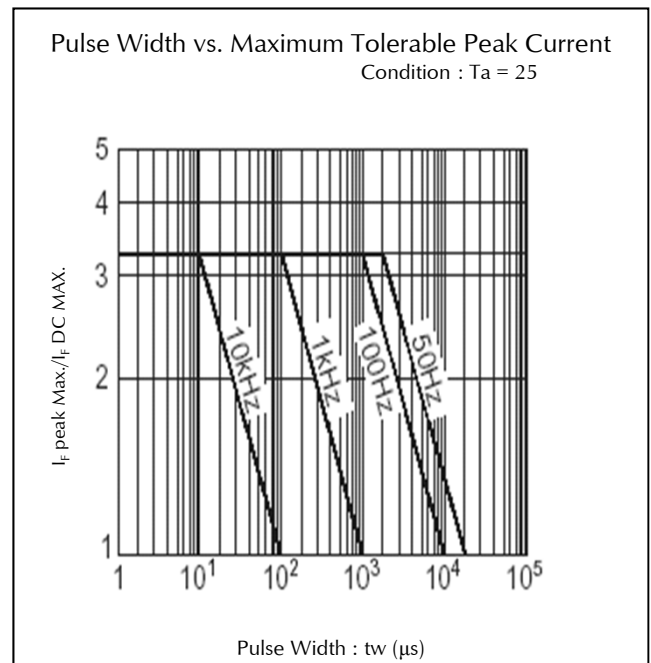
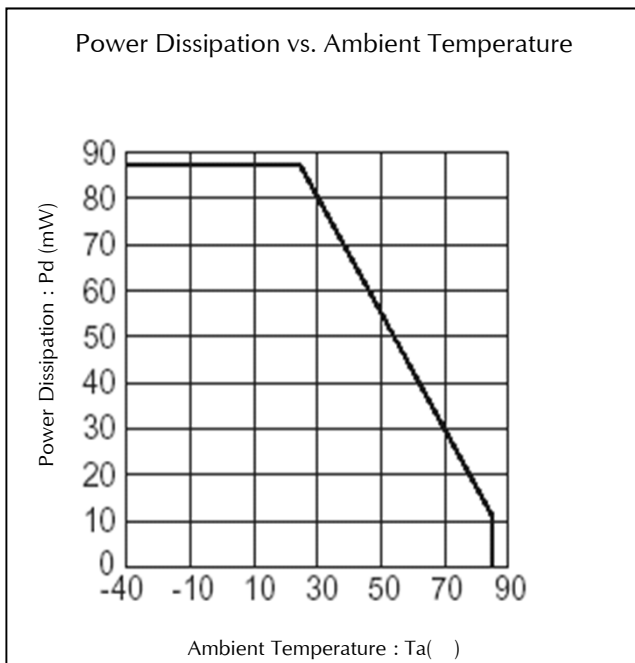
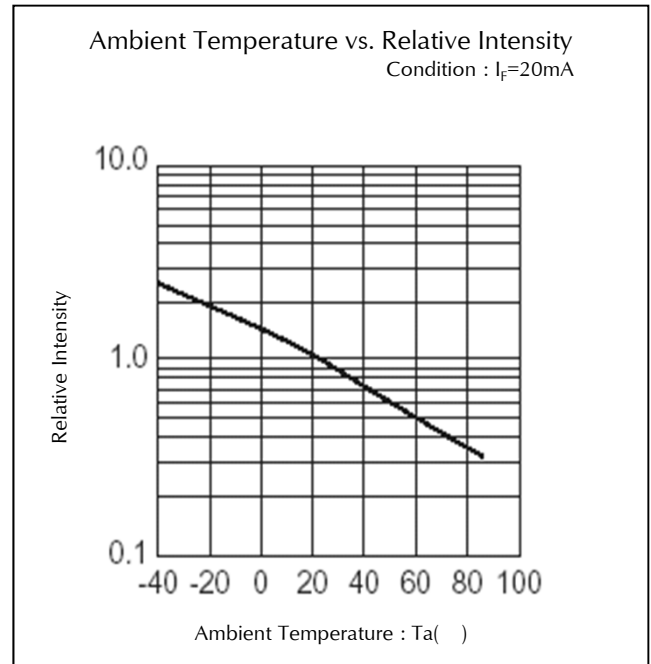
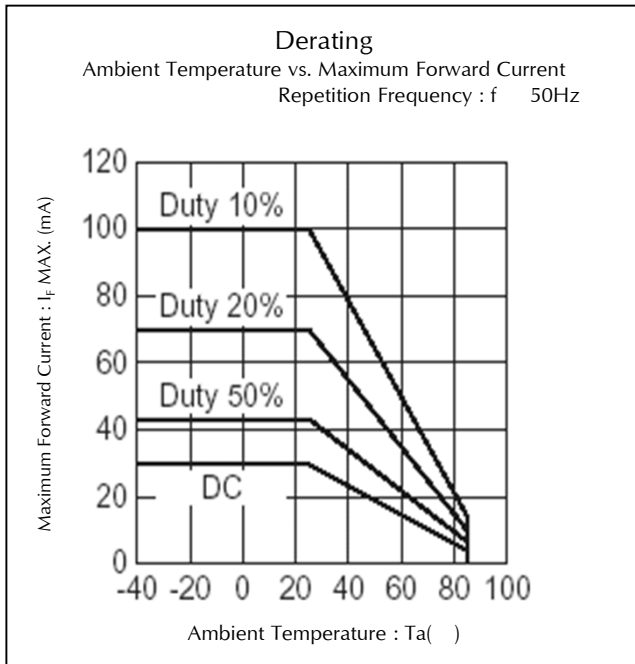

Technical Data(UR)

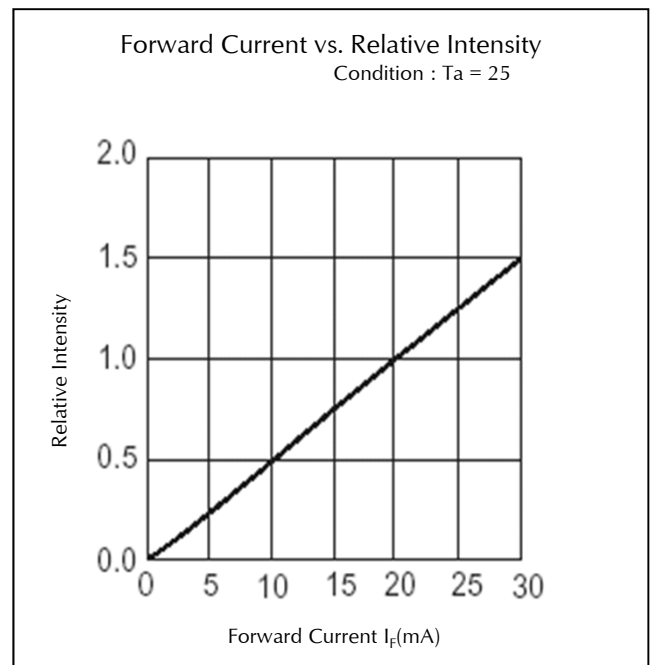
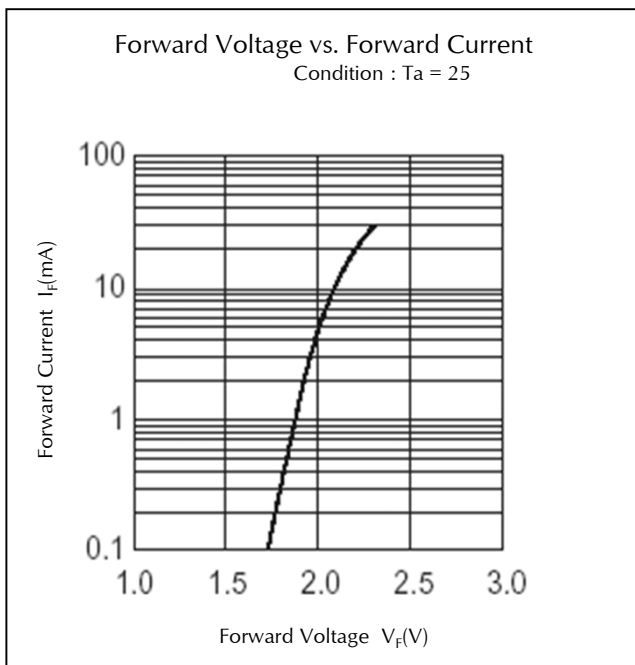
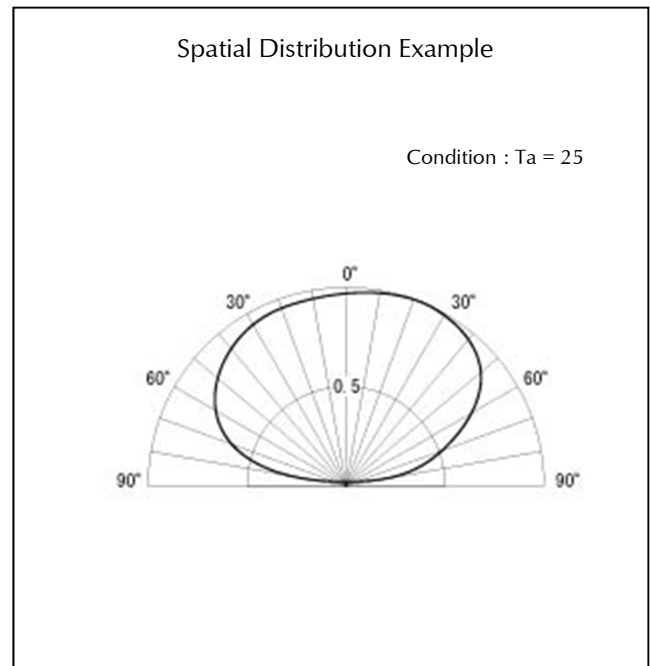
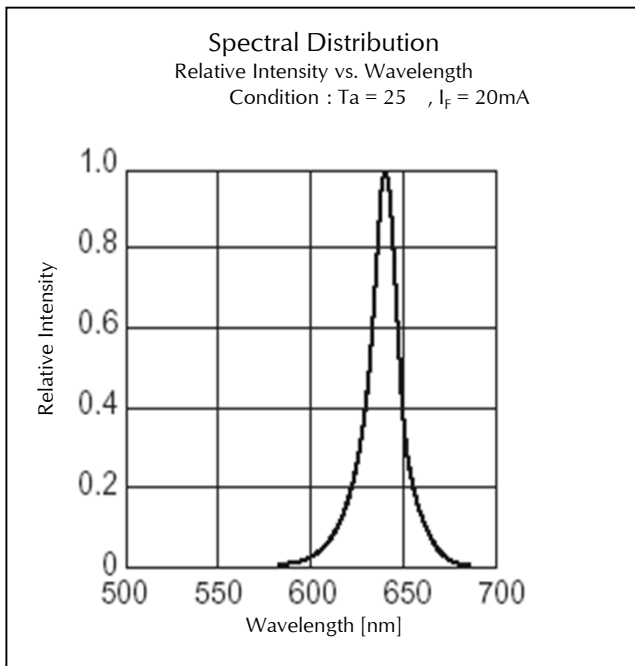

Technical Data(UR)

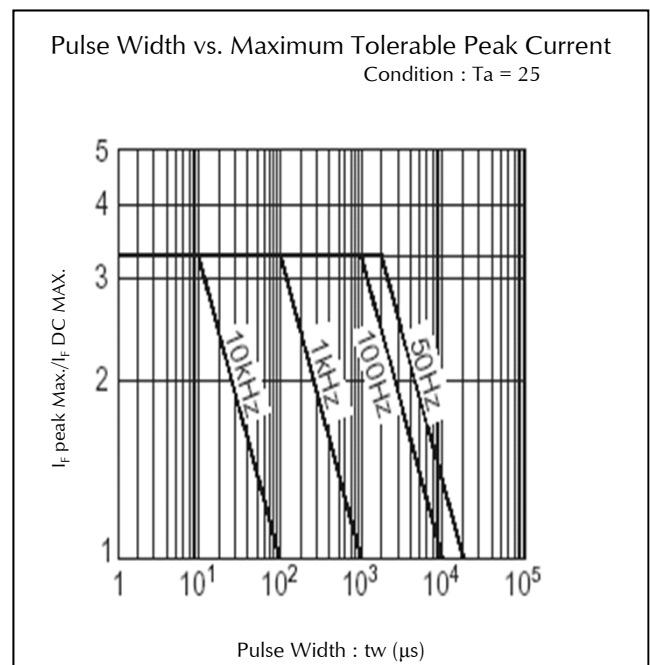
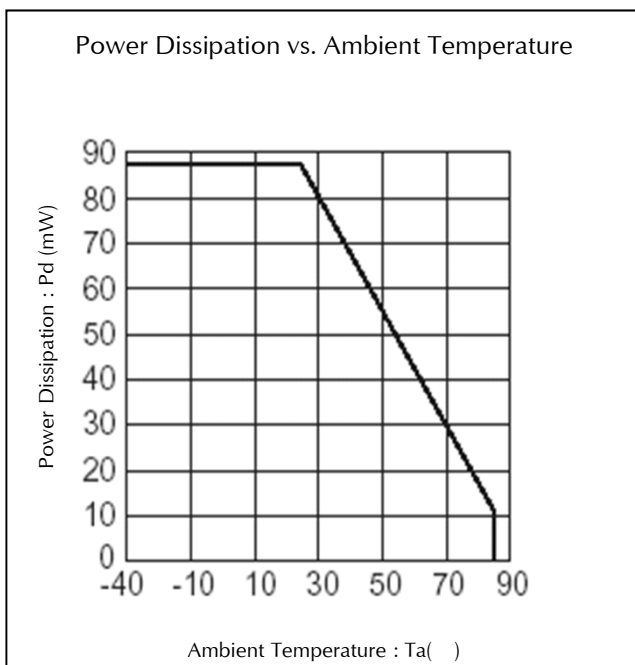
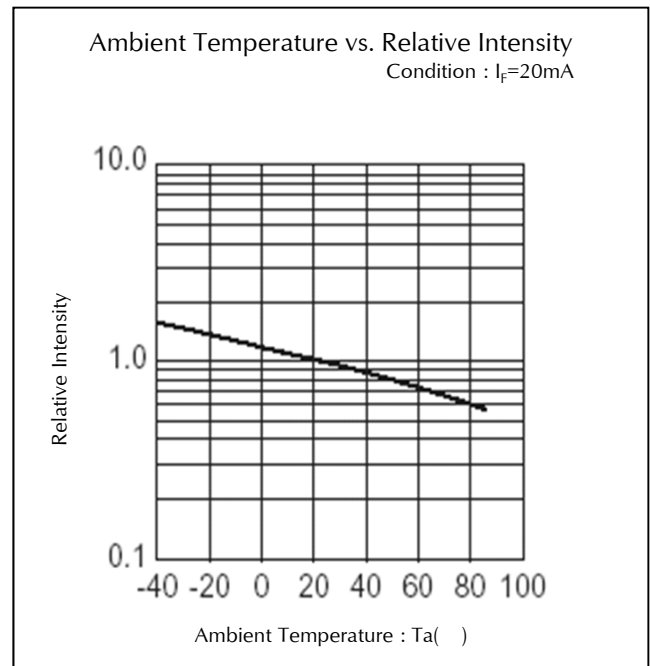
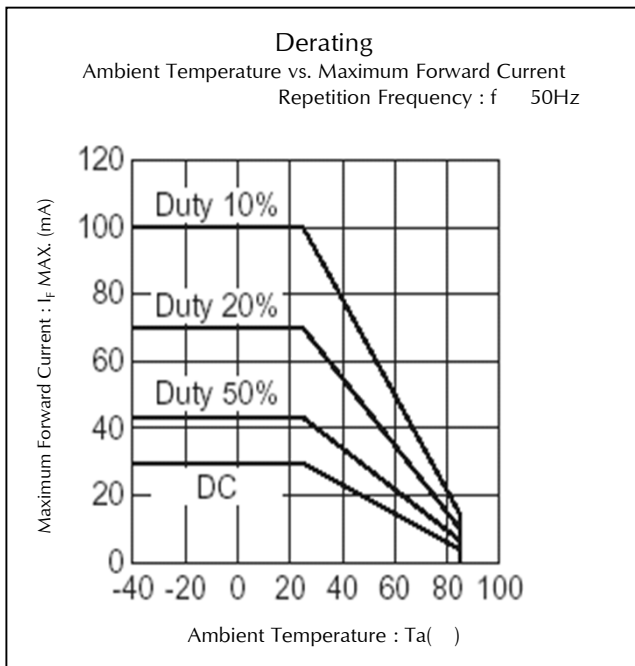

Package Dimensions

(Unit: mm)

Weight: (2.84)mg

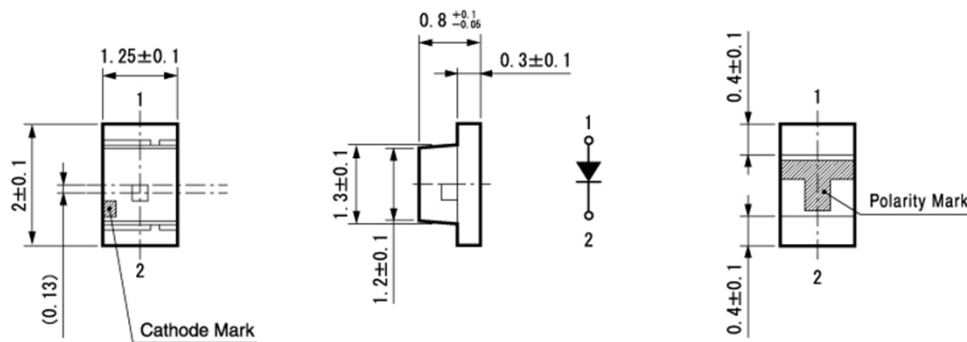

Recommended Soldering Pattern

(Unit: mm)

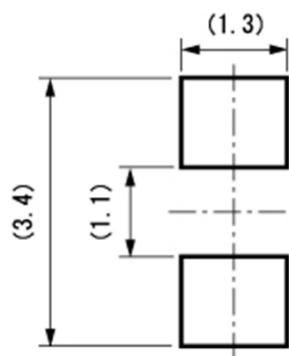

Taping Specification

(Unit: mm)

Quantity : 4,000pcs/ reel (standard)

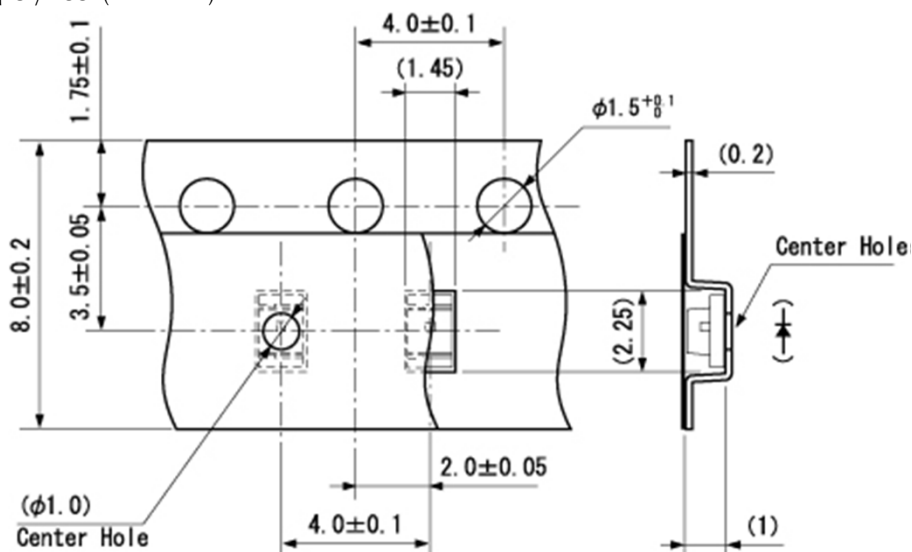

Reflow Soldering Conditions

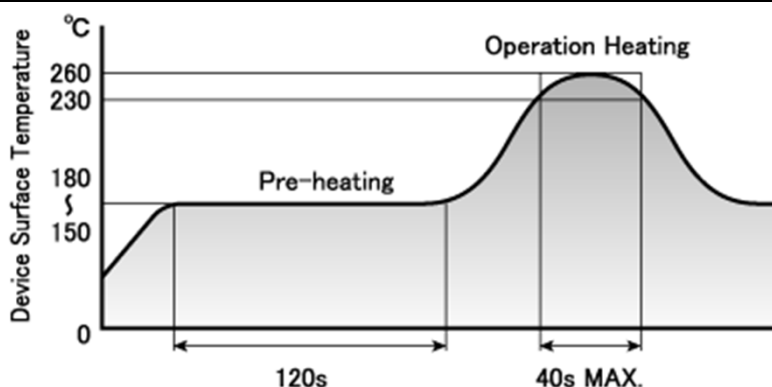

- 1) The above profile temperature gives the maximum temperature of the LED resin surface. Please set the temperature so as to avoid exceeding this range.
- 2) Total times of reflow soldering process shall be no more than 2 times. When the second reflow soldering process is performed, intervals between the first and second reflow should be short as possible (while allowing some time for the component to return to normal temperature after the first reflow) in order to prevent the LED from absorbing moisture.
- 3) Temperature fluctuation to the LED during the pre-heating process shall be minimized.

Manual Soldering Conditions

| | | |
|------------------------------|--------|--------|
| Iron tip temp. | 350 | (MAX.) |
| Soldering time and frequency | 3 s | (MAX.) |
| | 1 time | (MAX.) |

Reliability Testing Result

| Reliability Testing Result | Applicable Standard | Testing Conditions | Duration | Failure |
|-------------------------------|-----------------------|---|----------|---------|
| Room Temp. Operating Life | EIAJ ED-4701/100(101) | Ta = 25°C, If = Maximum Rated Current | 1,000 h | 0/25 |
| Resistance to Soldering Heat | EIAJ ED-4701/300(301) | Pre-heating : 150~180°C 120s Max. Operation Heating : 230°C 40s Max. Peak Temperature : 260°C | Twice | 0/25 |
| Temperature Cycling | EIAJ ED-4701/100(105) | Minimum Rated Storage Temperature(30min) ~Normal Temperature(15min) ~Maximum Rated Storage Temperature(30min) ~Normal Temperature(15min) | 5 cycles | 0/25 |
| Wet High Temp. Storage Life | EIAJ ED-4701/100(103) | Ta = 60±2°C, RH = 90±5% | 1,000 h | 0/25 |
| High Temp. Storage Life | EIAJ ED-4701/200(201) | Ta = Maximum Rated Storage Temperature | 1,000 h | 0/25 |
| Low Temp. Storage Life | EIAJ ED-4701/200(202) | Ta = Minimum Rated Storage Temperature | 1,000 h | 0/25 |
| Vibration, Variable Frequency | EIAJ ED-4701/400(403) | 98.1m/s ² (10G), 100 ~ 2KHz sweep for 20min., XYZ each direction | 2 h | 0/10 |

Failure Criteria

| Items | Symbols | Conditions | Failure criteria |
|---------------------|----------------|---|---|
| Luminous Intensity | Iv | If Value of each product Luminous Intensity | Testing Min. Value < Spec. Min. Value x 0.5 |
| Forward Voltage | V _F | If Value of each product Forward Voltage | Testing Max. Value ≥ Spec. Max. Value x 1.2 |
| Reverse Current | I _R | V _R = Maximum Rated Reverse Voltage V | Testing Max. Value ≥ Spec. Max. Value x 2.5 |
| Cosmetic Appearance | - | - | Occurrence of notable decoloration, deformation and cracking |

Special Notice to Customers Using the Products and Technical Information Shown in This Data Sheet

- 1) The technical information shown in the data sheets are limited to the typical characteristics and circuit examples of the referenced products. It does not constitute the warranting of industrial property nor the granting of any license.
- 2) For the purpose of product improvement, the specifications, characteristics and technical data described in the data sheets are subject to change without prior notice. Therefore it is recommended that the most updated specifications be used in your design.
- 3) When using the products described in the data sheets, please adhere to the maximum ratings for operating voltage, heat dissipation characteristics, and other precautions for use. We are not responsible for any damage which may occur if these specifications are exceeded.
- 4) The products that have been described to this catalog are manufactured so that they will be used for the electrical instrument of the benchmark (OA equipment, telecommunications equipment, AV machine, home appliance and measuring instrument).
The application of aircrafts, space borne application, transportation equipment, medical equipment and nuclear power control equipment, etc. needs a high reliability and safety, and the breakdown and the wrong operation might influence the life or the human body. Please consult us beforehand if you plan to use our product for the usages of aircrafts, space borne application, transportation equipment, medical equipment and nuclear power control equipment, etc. except OA equipment, telecommunications equipment, AV machine, home appliance and measuring instrument.
- 5) In order to export the products or technologies described in this data sheet which are under the "Foreign Exchange and Foreign Trade Control Law," it is necessary to first obtain an export permit from the Japanese government.
- 6) No part of this data sheet may be reprinted or reproduced without prior written permission from Stanley Electric Co., Ltd.
- 7) The most updated edition of this data sheet can be obtained from the address below:
<http://www.stanley-components.com>