

PRELIMINARY SPEC

**Features**

- 1.6mmX0.8mm SMT LED, 0.75mm THICKNESS.
- LOW POWER CONSUMPTION.
- WIDE VIEWING ANGLE.
- IDEAL FOR BACKLIGHT AND INDICATOR.
- VARIOUS COLORS AND LENS TYPES AVAILABLE.
- PACKAGE: 2000PCS / REEL .
- MOISTURE SENSITIVITY LEVEL : LEVEL 3.
- RoHS COMPLIANT.



ATTENTION  
 OBSERVE PRECAUTIONS  
 FOR HANDLING  
 ELECTROSTATIC  
 DISCHARGE  
 SENSITIVE  
 DEVICES

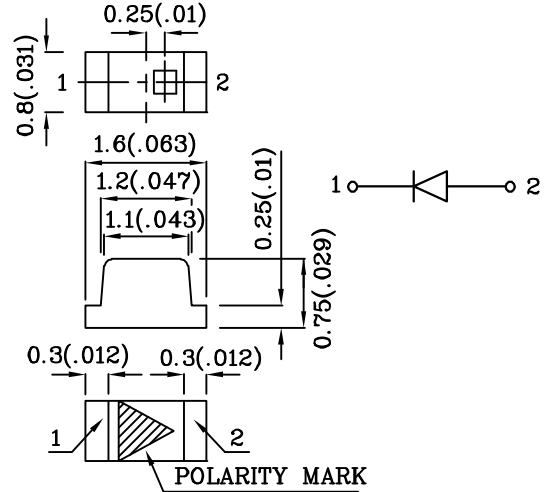

Notes:

1. All dimensions are in millimeters (inches).
2. Tolerance is  $\pm 0.1(0.004)$  unless otherwise noted.
3. Specifications are subject to change without notice.

Absolute Maximum Ratings (TA=25°C)		M2BG (InGaN)	Unit
Reverse Voltage	V <sub>R</sub>	5	V
Forward Current	I <sub>F</sub>	30	mA
Forward Current (peak) 1/10 Duty Cycle 0.1ms Pulse Width	i <sub>FS</sub>	100	mA
Power Dissipation	P <sub>T</sub>	111	mW
Operating Temperature	T <sub>A</sub>	-40 ~ +85	°C
Storage Temperature	T <sub>stg</sub>	-40 ~ +85	
Electrostatic Discharge Threshold (HBM)		1000	V

Operating Characteristics (TA=25°C)		M2BG (InGaN)	Unit
Forward Voltage (Typ.) (I <sub>F</sub> =20mA)	V <sub>F</sub>	3.2	V
Forward Voltage (Max.) (I <sub>F</sub> =20mA)	V <sub>F</sub>	3.7	V
Reverse Current (Max.) (V <sub>R</sub> =5V)	I <sub>R</sub>	10	uA
Wavelength Of Peak Emission (Typ.) (I <sub>F</sub> =20mA)	λ P	525	nm
Wavelength Of Dominant Emission (Typ.) (I <sub>F</sub> =20mA)	λ D	535	nm
Spectral Line Full Width At Half-Maximum (Typ.) (I <sub>F</sub> =20mA)	Δλ	39	nm
Capacitance (Typ.) (V <sub>F</sub> =0V, f=1MHz)	C	65	pF

Part Number	Emitting Color	Emitting Material	Lens-color	Luminous Intensity (I <sub>F</sub> =20mA) mcd	Wavelength nm λ P	Viewing Angle 2 θ 1/2
				min.      typ.		
ZM2BG53W-1	Green	InGaN	Water Clear	380      795	525	120 °

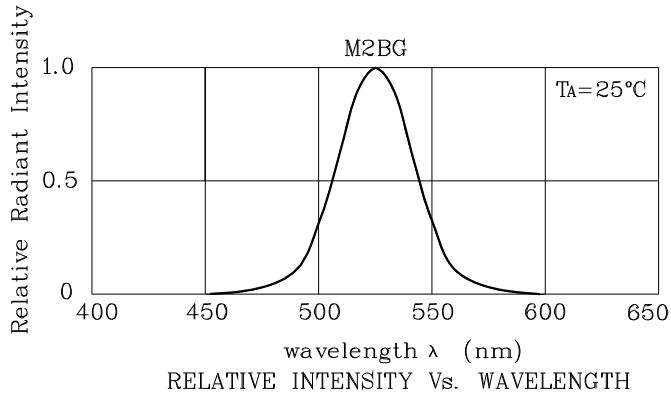

❖ M2BG

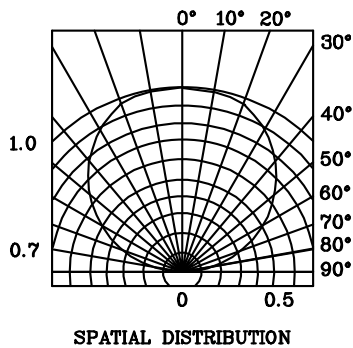
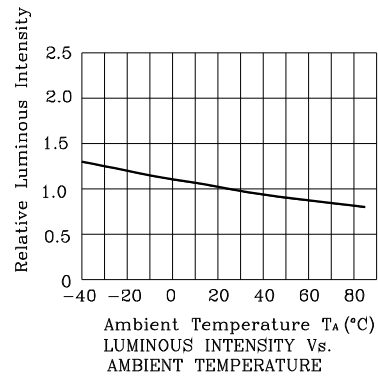
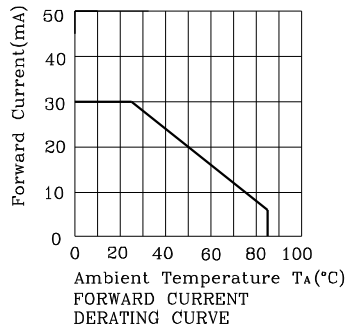
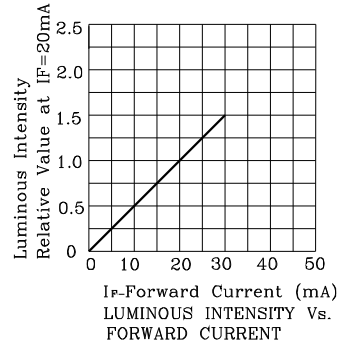
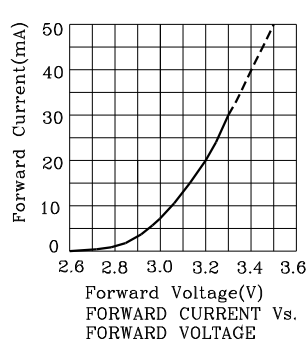

Reflow Soldering Profile For Lead-free SMT Process.

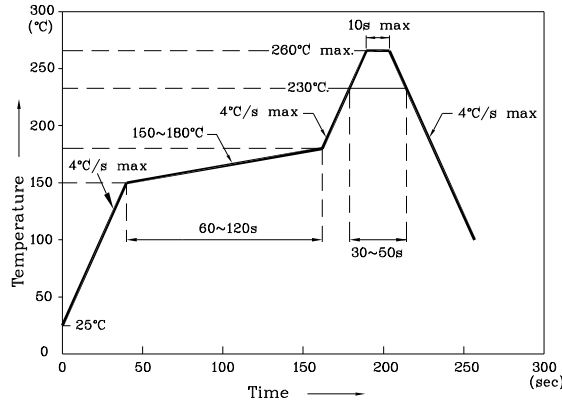

Notes:

1. Maximum soldering temperature should not exceed 260°C.
2. Recommended reflow temperature: 145°C-260°C.
3. Do not put stress to the epoxy resin during high temperatures conditions.

❖ Recommended Soldering Pattern  
(Units : mm;Tolerance:± 0.1)

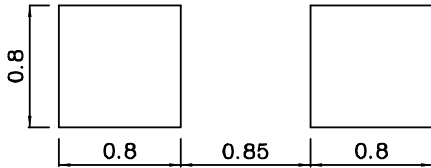

❖ The device has a single mounting surface. The device must be mounted according to the specifications.

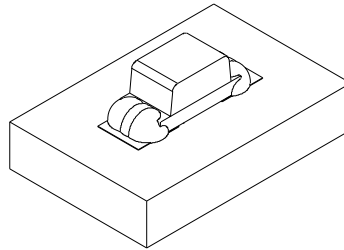

❖ Tape Specification (Units : mm)

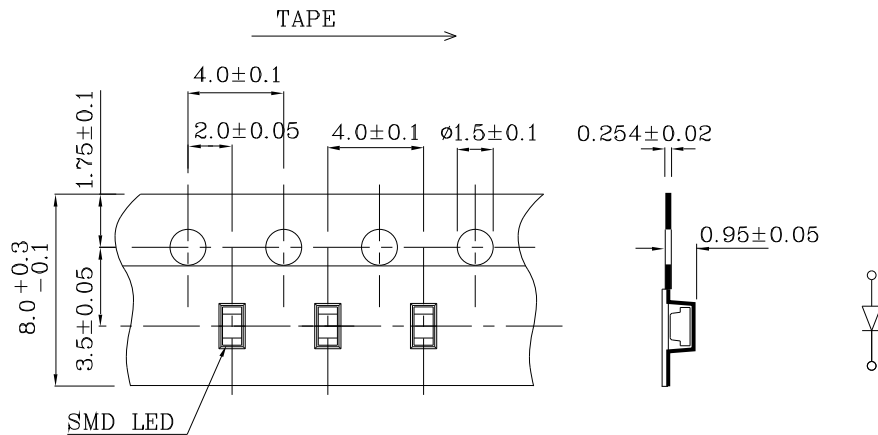

Remarks:

If special sorting is required (e.g. binning based on forward voltage, Luminous intensity / luminous flux, or wavelength), the typical accuracy of the sorting process is as follows:

1. Wavelength: +/-1nm
2. Luminous Intensity / Luminous Flux: +/-15%
3. Forward Voltage: +/-0.1V



Note: Accuracy may depend on the sorting parameters.

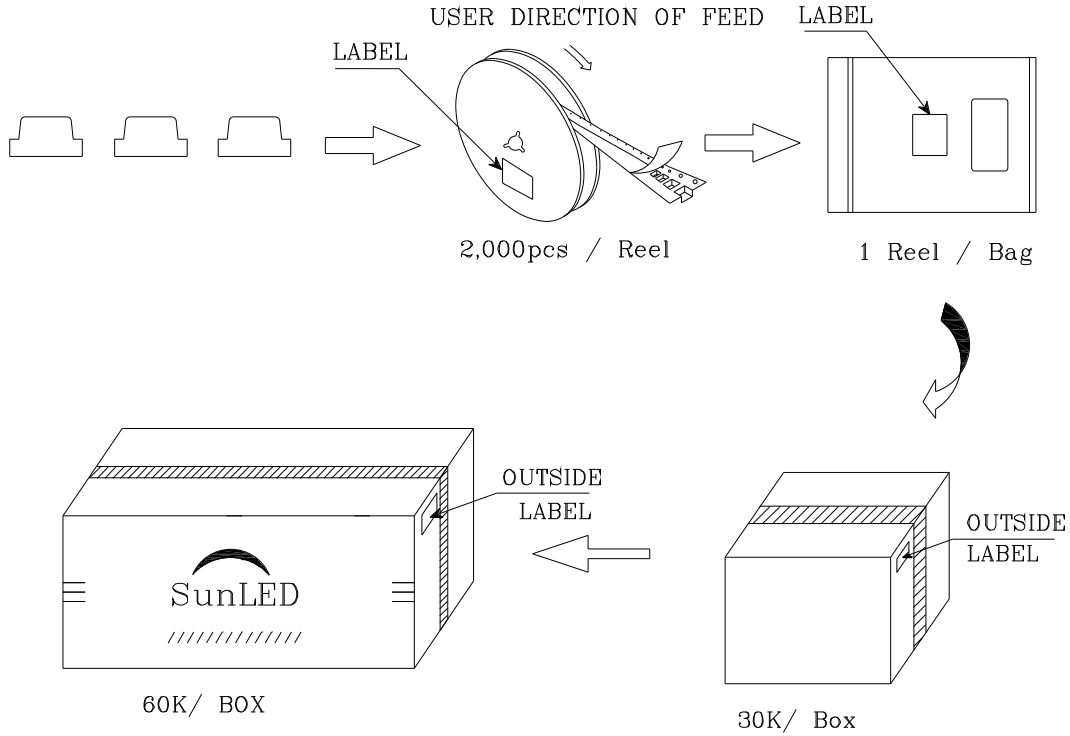

**PACKING & LABEL SPECIFICATIONS**

**ZM2BG53W-1**



		
P/NO : Zxxx53x-1		
QTY : 2000 pcs	CODE: XXX	
S/N : XX		
LOT NO:		
 XXXXXXXXXXXXXXXXXXXXXXXX		
RoHS Compliant		