

SS Type

Type No. Lighting Color
 LNJ308G8JRA Green

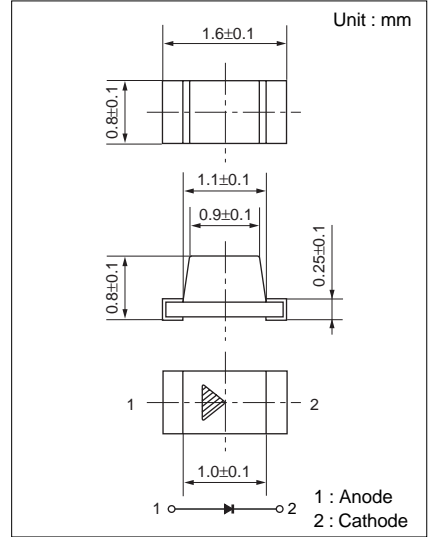

絶対最大定格 Absolute Maximum Ratings (Ta=25°C)

Lighting Color	P _D (mW)	I _F (mA)	I _{FP} (mA)*	V _R (V)	T _{opr} (°C)	T _{stg} (°C)
Green	50	20	100	4	-25 ~ +85	-40 ~ +100

* I_{FP}の条件は、duty 10%, Pulse width 1 msec. The condition of I_{FP} is duty 10%, Pulse width 1 msec

電気的光学的特性 Electro-Optical Characteristics (Ta=25°C)

Type No.	Lighting Color	Lens Color	I _O		I _F	V _F		λ _P	Δλ	I _F	I _R	
			typ	min		typ	max	typ	typ		max	V _R
LNJ308G8JRA	Green	Green Diffused	6.8	3.6	10	2.0	2.6	565	30	10	10	4
Unit	—	—	mcd	mcd	mA	V	V	nm	nm	mA	μA	V

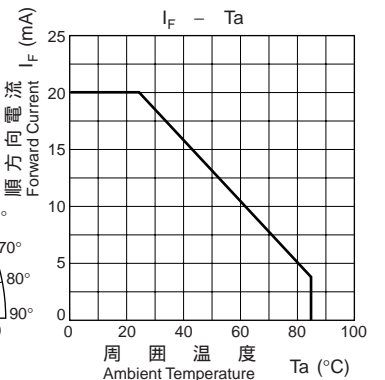
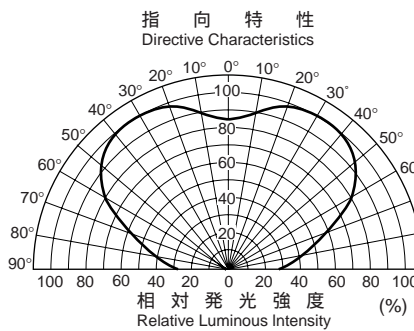
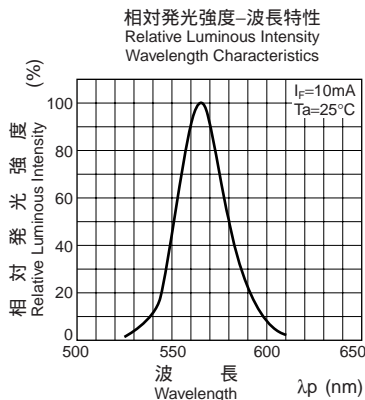
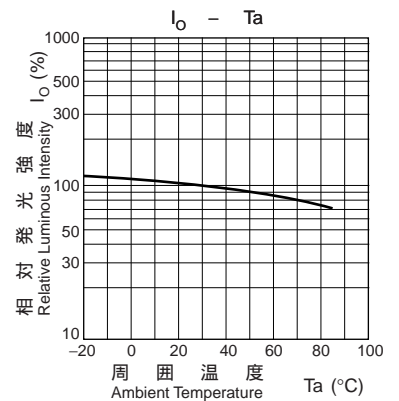
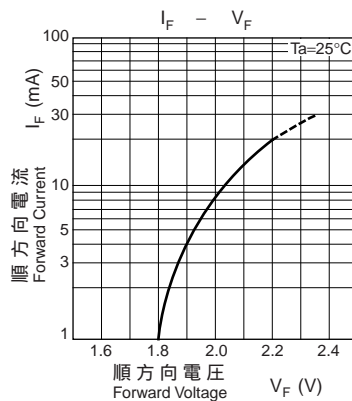
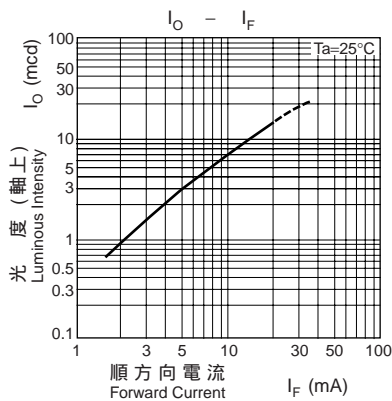

This datasheet has been download from:

www.datasheetcatalog.com

Datasheets for electronics components.