

No. STSE-CC7014C

<Cat.No.070606>

SPECIFICATIONS FOR NICHIA CHIP TYPE WHITE LED

MODEL : NSSW006T

NICHIA CORPORATION

1.SPECIFICATIONS

(1) Absolute Maximum Ratings (Ta=25°C)

| Item | Symbol | Absolute Maximum Rating | Unit |
|-----------------------|------------------|---|------|
| Forward Current | I _F | 35 | mA |
| Pulse Forward Current | I _{FP} | 100 | mA |
| Reverse Voltage | V _R | 5 | V |
| Power Dissipation | P _D | 123 | mW |
| Operating Temperature | T _{opr} | -30 ~ + 85 | °C |
| Storage Temperature | T _{stg} | -40 ~ +100 | °C |
| Soldering Temperature | T _{sld} | Reflow Soldering : 260°C for 10sec. Hand Soldering : 350°C for 3sec. | |

I_{FP} Conditions : Pulse Width ≤ 10msec. and Duty ≤ 1/10

(2) Initial Electrical/Optical Characteristics (Ta=25°C)

| Item | Symbol | Condition | Typ. | Max. | Unit |
|---|----------------|------------------------|--------|------|------|
| Forward Voltage | V _F | I _F =20[mA] | (3.2) | 3.5 | V |
| Reverse Current | I _R | V _R = 5[V] | - | 50 | μA |
| Luminous Intensity (Chromaticity Coordinate 1) | I _v | I _F =20[mA] | (2.20) | - | cd |
| Chromaticity Coordinate*1 | x | I _F =20[mA] | 0.310 | - | - |
| | y | I _F =20[mA] | 0.320 | - | - |
| Luminous Intensity (Chromaticity Coordinate 2) | I _v | I _F =20[mA] | (2.05) | - | cd |
| Luminous Flux (Chromaticity Coordinate 2) | φ _v | I _F =20[mA] | (5.5) | - | lm |
| Chromaticity Coordinate*2 | x | I _F =20[mA] | 0.300 | - | - |
| | y | I _F =20[mA] | 0.295 | - | - |

* Please refer to CIE 1931 chromaticity diagram.

(3) Ranking (Ta=25°C)

| Item | Symbol | Condition | Min. | Max. | Unit | |
|--------------------|----------|----------------|------------------------|------|------|----|
| Luminous Intensity | Rank A22 | I _v | I _F =20[mA] | 2.20 | 2.30 | cd |
| | Rank A21 | I _v | I _F =20[mA] | 2.10 | 2.20 | cd |
| | Rank A20 | I _v | I _F =20[mA] | 2.00 | 2.10 | cd |
| | Rank A19 | I _v | I _F =20[mA] | 1.90 | 2.00 | cd |
| | Rank A18 | I _v | I _F =20[mA] | 1.80 | 1.90 | cd |
| | Rank A17 | I _v | I _F =20[mA] | 1.70 | 1.80 | cd |

* Luminous Intensity Measurement allowance is ± 7%.

Color Ranks

(I_F=20mA, Ta=25°C)

| Rank a52 | | | | |
|----------|--------|--------|--------|--------|
| x | 0.2800 | 0.2720 | 0.2820 | 0.2880 |
| y | 0.2480 | 0.2580 | 0.2720 | 0.2620 |

| Rank a56 | | | | |
|----------|--------|--------|--------|--------|
| x | 0.2830 | 0.2800 | 0.2880 | 0.2910 |
| y | 0.2440 | 0.2480 | 0.2620 | 0.2580 |

| Rank a57 | | | |
|----------|--------|--------|--------|
| x | 0.2720 | 0.2793 | 0.2820 |
| y | 0.2580 | 0.2755 | 0.2720 |

| Rank a62 | | | | |
|----------|--------|--------|--------|--------|
| x | 0.2880 | 0.2820 | 0.2910 | 0.2960 |
| y | 0.2620 | 0.2720 | 0.2870 | 0.2760 |

| Rank a66 | | | | |
|----------|--------|--------|--------|--------|
| x | 0.2910 | 0.2880 | 0.2960 | 0.2980 |
| y | 0.2580 | 0.2620 | 0.2760 | 0.2710 |

| Rank a67 | | | | |
|----------|--------|--------|--------|--------|
| x | 0.2820 | 0.2793 | 0.2887 | 0.2910 |
| y | 0.2720 | 0.2755 | 0.2916 | 0.2870 |

| Rank bj2 | | | | |
|----------|--------|--------|--------|--------|
| x | 0.2960 | 0.2910 | 0.2990 | 0.3040 |
| y | 0.2760 | 0.2870 | 0.3010 | 0.2900 |

| Rank bj6 | | | | |
|----------|--------|--------|--------|--------|
| x | 0.2980 | 0.2960 | 0.3040 | 0.3062 |
| y | 0.2710 | 0.2760 | 0.2900 | 0.2853 |

| Rank bj7 | | | | |
|----------|--------|--------|--------|--------|
| x | 0.2910 | 0.2887 | 0.2968 | 0.2990 |
| y | 0.2870 | 0.2916 | 0.3058 | 0.3010 |

| Rank bk2 | | | | |
|----------|--------|--------|--------|--------|
| x | 0.3040 | 0.2990 | 0.3070 | 0.3120 |
| y | 0.2900 | 0.3010 | 0.3150 | 0.3040 |

| Rank bk6 | | | | |
|----------|--------|--------|--------|--------|
| x | 0.3062 | 0.3040 | 0.3120 | 0.3142 |
| y | 0.2853 | 0.2900 | 0.3040 | 0.2993 |

| Rank bk7 | | | | |
|----------|--------|--------|--------|--------|
| x | 0.2990 | 0.2968 | 0.3048 | 0.3070 |
| y | 0.3010 | 0.3058 | 0.3198 | 0.3150 |

* Color Coordinates Measurement allowance is ± 0.005 .

* One delivery will include up to four color ranks and six luminous intensity ranks of the products.

The quantity-ratio of the ranks is decided by Nichia.

2.INITIAL OPTICAL/ELECTRICAL CHARACTERISTICS

Please refer to figure's page.

3.OUTLINE DIMENSIONS AND MATERIALS

Please refer to figure's page.

Material as follows ;

| | | |
|---------------------|---|---|
| Package | : | Heat-Resistant Polymer |
| Encapsulating Resin | : | Silicone Resin (with Diffused + Phosphor) |
| Electrodes | : | Ag Plating Copper Alloy |

4.PACKAGING

· The LEDs are packed in cardboard boxes after taping.

Please refer to figure's page.

The label on the minimum packing unit shows ; Part Number, Lot Number, Ranking, Quantity

· In order to protect the LEDs from mechanical shock, we pack them in cardboard boxes for transportation.

· The LEDs may be damaged if the boxes are dropped or receive a strong impact against them, so precautions must be taken to prevent any damage.

· The boxes are not water resistant and therefore must be kept away from water and moisture.

· When the LEDs are transported, we recommend that you use the same packing method as Nichia.

5.LOT NUMBER

The first six digits number shows **lot number**.

The lot number is composed of the following characters;

○ □ × × × × - △ ■

○ - Year (6 for 2006, 7 for 2007)

□ - Month (1 for Jan., 9 for Sep., A for Oct., B for Nov.)

× × × × - Nichia's Product Number

△ - Ranking by Color Coordinates

■ - Ranking by Luminous Intensity

6.RELIABILITY

(1) TEST ITEMS AND RESULTS

| Test Item | Standard Test Method | Test Conditions | Note | Number of Damaged |
|---|--------------------------|---|--------------------|-------------------|
| Resistance to Soldering Heat (Reflow Soldering) | JEITA ED-4701 300 301 | Tsld=260°C, 10sec. (Pre treatment 30°C,70%,168hrs.) | 2 times | 0/50 |
| Solderability (Reflow Soldering) | JEITA ED-4701 300 303 | Tsld=215 ± 5°C, 3sec. (Lead Solder) | 1 time over 95% | 0/50 |
| Thermal Shock | JEITA ED-4701 300 307 | 0°C ~ 100°C 15sec. 15sec. | 20 cycles | 0/50 |
| Temperature Cycle | JEITA ED-4701 100 105 | -40°C ~ 25°C ~ 100°C ~ 25°C 30min. 5min. 30min. 5min. | 100 cycles | 0/50 |
| Moisture Resistance Cyclic | JEITA ED-4701 200 203 | 25°C ~ 65°C ~ -10°C 90%RH 24hrs./1cycle | 10 cycles | 0/50 |
| High Temperature Storage | JEITA ED-4701 200 201 | Ta=100°C | 1000 hrs. | 0/50 |
| Temperature Humidity Storage | JEITA ED-4701 100 103 | Ta=60°C, RH=90% | 1000 hrs. | 0/50 |
| Low Temperature Storage | JEITA ED-4701 200 202 | Ta=-40°C | 1000 hrs. | 0/50 |
| Steady State Operating Life Condition 1 | | Ta=25°C, IF=20mA | 1000 hrs. | 0/50 |
| Steady State Operating Life Condition 2 | | Ta=25°C, IF=35mA | 500 hrs. | 0/50 |
| Steady State Operating Life of High Temperature | | Ta=85°C, IF=8.5mA | 1000 hrs. | 0/50 |
| Steady State Operating Life of High Humidity Heat | | 60°C, RH=90%, IF=15mA | 500 hrs. | 0/50 |
| Steady State Operating Life of Low Temperature | | Ta=-30°C, IF=20mA | 1000 hrs. | 0/50 |
| Vibration | JEITA ED-4701 400 403 | 100 ~ 2000 ~ 100Hz Sweep 4min. 200m/s ² 3directions, 4cycles | 48min. | 0/50 |
| Substrate Bending | JEITA ED-4702 | 3mm, 5 ± 1 sec. | 1 time | 0/50 |
| Adhesion Strength | JEITA ED-4702 | 5N, 10 ± 1 sec. | 1 time | 0/50 |

(2) CRITERIA FOR JUDGING DAMAGE

| Item | Symbol | Test Conditions | Criteria for Judgement | |
|--------------------|----------------|----------------------|------------------------|----------------|
| | | | Min. | Max. |
| Forward Voltage | V _F | I _F =20mA | - | U.S.L.*) × 1.1 |
| Reverse Current | I _R | V _R =5V | - | U.S.L.*) × 2.0 |
| Luminous Intensity | I _V | I _F =20mA | L.S.L.***) × 0.7 | - |

*) U.S.L. : Upper Standard Level

**) L.S.L. : Lower Standard Level

7.CAUTIONS

The LEDs are devices which are materialized by combining Blue LEDs and special phosphors. Consequently, the color of the LEDs is changed a little by an operating current. Care should be taken after due consideration when using LEDs.

(1) Moisture Proof Package

- When moisture is absorbed into the SMT package it may vaporize and expand during soldering. There is a possibility that this can cause exfoliation of the contacts and damage to the optical characteristics of the LEDs. For this reason, the moisture proof package is used to keep moisture to a minimum in the package.
- The moisture proof package is made of an aluminum moisture proof bag. A package of a moisture absorbent material (silica gel) is inserted into the aluminum moisture proof bag. The silica gel changes its color from blue to pink as it absorbs moisture.

(2) Storage

· Storage Conditions

Before opening the package :

The LEDs should be kept at 30°C or less and 90%RH or less. The LEDs should be used within a year. When storing the LEDs, moisture proof packaging with absorbent material (silica gel) is recommended.

After opening the package :

The LEDs should be kept at 30°C or less and 70%RH or less. The LEDs should be soldered within 168 hours (7days) after opening the package. If unused LEDs remain, they should be stored in moisture proof packages, such as sealed containers with packages of moisture absorbent material (silica gel). It is also recommended to return the LEDs to the original moisture proof bag and to reseal the moisture proof bag again.

- If the moisture absorbent material (silica gel) has faded away or the LEDs have exceeded the storage time, baking treatment should be performed using the following conditions.

Baking treatment : more than 24 hours at $65 \pm 5^{\circ}\text{C}$

- Nichia LED electrodes and leadframes are silver plated copper alloy. The silver surface may be affected by environments which contain corrosive substances. Please avoid conditions which may cause the LED to corrode, tarnish or discolor. This corrosion or discoloration might lower solderability or might affect on optical characteristics.
- Please avoid rapid transitions in ambient temperature, especially in high humidity environments where condensation can occur.

(3) Heat Generation

- Thermal design of the end product is of paramount importance. Please consider the heat generation of the LED when making the system design. The coefficient of temperature increase per input electric power is affected by the thermal resistance of the circuit board and density of LED placement on the board, as well as other components. It is necessary to avoid intense heat generation and operate within the maximum ratings given in this specification.
- The operating current should be decided after considering the ambient maximum temperature of LEDs.

(4) Soldering Conditions

- The LEDs can be soldered in place using the reflow soldering method. Nichia cannot make a guarantee on the LEDs after they have been assembled using the dip soldering method.
- Recommended soldering conditions

| | Reflow Soldering | | Hand Soldering | |
|------------------|-----------------------------------|--|----------------|--|
| | Lead Solder | Lead-free Solder | Temperature | 350°C Max. 3 sec. Max. (one time only) |
| Pre-heat | 120 ~ 150°C | 180 ~ 200°C | Soldering time | |
| Pre-heat time | 120 sec. Max. | 120 sec. Max. | | |
| Peak temperature | 240°C Max. | 260°C Max. | | |
| Soldering time | 10 sec. Max. | 10 sec. Max. | | |
| Condition | refer to Temperature - profile ①. | refer to Temperature - profile ②. (N ₂ reflow is recommended.) | | |

* Although the recommended soldering conditions are specified in the above table, reflow or hand soldering at the lowest possible temperature is desirable for the LEDs.

* A rapid-rate process is not recommended for cooling the LEDs down from the peak temperature.

[Temperature-profile (Surface of circuit board)]

Use the conditions shown to the under figure.

<① : Lead Solder>

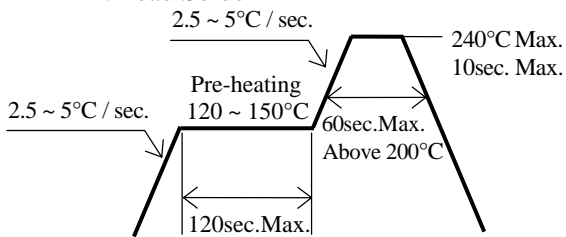

<② : Lead-free Solder>

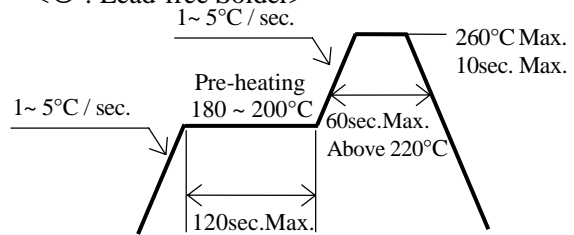

[Recommended soldering pad design]

Use the following conditions shown in the figure.

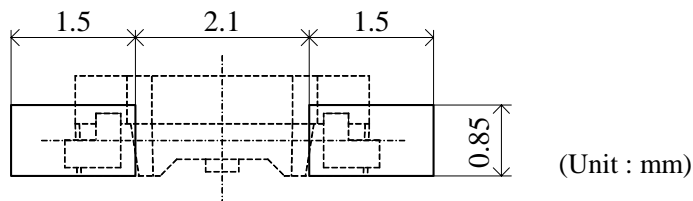

- Occasionally there is a brightness decrease caused by the influence of heat or ambient atmosphere during air reflow. It is recommended that the User use the nitrogen reflow method.
- Repairing should not be done after the LEDs have been soldered. When repairing is unavoidable, a double-head soldering iron should be used. It should be confirmed beforehand whether the characteristics of the LEDs will or will not be damaged by repairing.
- Reflow soldering should not be done more than two times.
- When soldering, do not put stress on the LEDs during heating.
- After soldering, do not warp the circuit board.

(5) Cleaning

- It is recommended that isopropyl alcohol be used as a solvent for cleaning the LEDs. When using other solvents, it should be confirmed beforehand whether the solvents will dissolve the package and the resin or not. Freon solvents should not be used to clean the LEDs because of worldwide regulations.
- Do not clean the LEDs by the ultrasonic. When it is absolutely necessary, the influence of ultrasonic cleaning on the LEDs depends on factors such as ultrasonic power and the assembled condition. Before cleaning, a pre-test should be done to confirm whether any damage to the LEDs will occur.

(6) Static Electricity

- Static electricity or surge voltage damages the LEDs.
It is recommended that a wrist band or an anti-electrostatic glove be used when handling the LEDs.
- All devices, equipment and machinery must be properly grounded. It is recommended that precautions be taken against surge voltage to the equipment that mounts the LEDs.
- When inspecting the final products in which LEDs were assembled, it is recommended to check whether the assembled LEDs are damaged by static electricity or not. It is easy to find static-damaged LEDs by a light-on test or a VF test at a lower current (below 1mA is recommended).
- Damaged LEDs will show some unusual characteristics such as the leak current remarkably increases, the forward voltage becomes lower, or the LEDs do not light at the low current.

Criteria : (VF > 2.0V at IF=0.5mA)

(7) Others

- NSSW006 complies with RoHS Directive.
- Care must be taken to ensure that the reverse voltage will not exceed the absolute maximum rating when using the LEDs with matrix drive.
- The LED light output is strong enough to injure human eyes. Precautions must be taken to prevent looking directly at the LEDs with unaided eyes for more than a few seconds.
- Flashing lights have been known to cause discomfort in people; you can prevent this by taking precautions during use. Also, people should be cautious when using equipment that has had LEDs incorporated into it.
- The LEDs described in this brochure are intended to be used for ordinary electronic equipment (such as office equipment, communications equipment, measurement instruments and household appliances). Consult Nichia's sales staff in advance for information on the applications in which exceptional quality and reliability are required, particularly when the failure or malfunction of the LEDs may directly jeopardize life or health (such as for airplanes, aerospace, submersible repeaters, nuclear reactor control systems, automobiles, traffic control equipment, life support systems and safety devices).
- User shall not reverse engineer by disassembling or analysis of the LEDs without having prior written consent from Nichia. When defective LEDs are found, the User shall inform Nichia directly before disassembling or analysis.
- The formal specifications must be exchanged and signed by both parties before large volume purchase begins.
- The appearance and specifications of the product may be modified for improvement without notice.

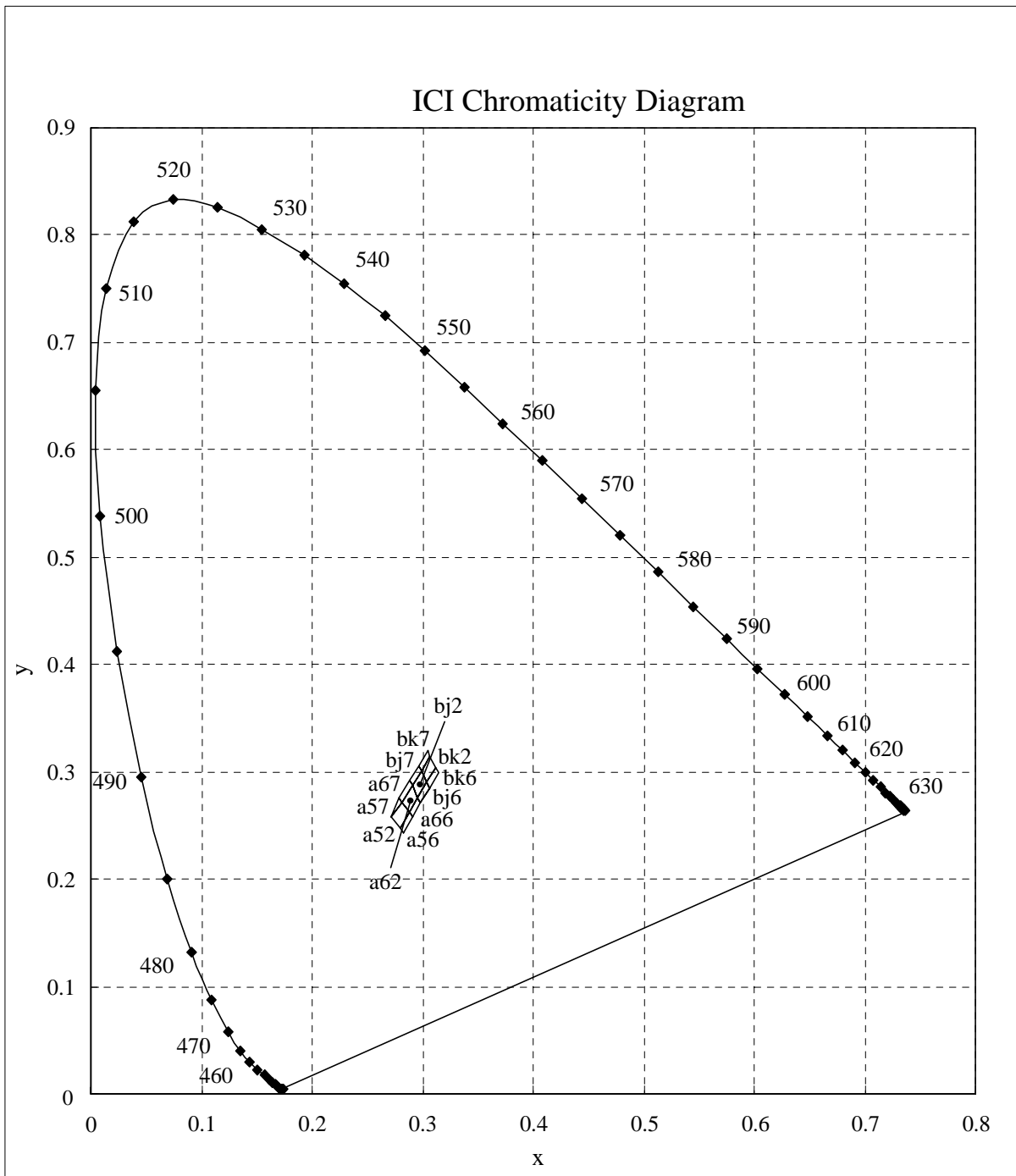

* Color Coordinates Measurement allowance is ± 0.005 .

■ Forward Voltage vs. Forward Current

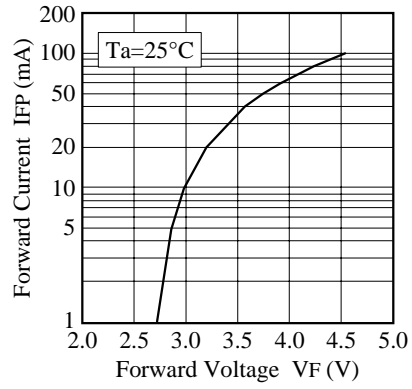

■ Forward Current vs. Relative Luminosity

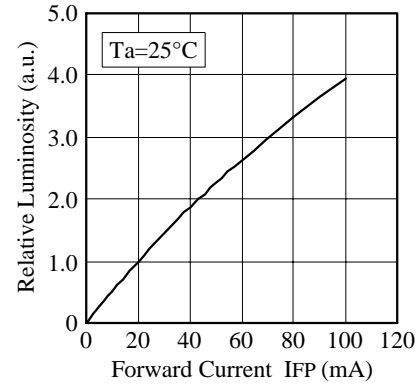

■ Duty Ratio vs. Allowable Forward Current

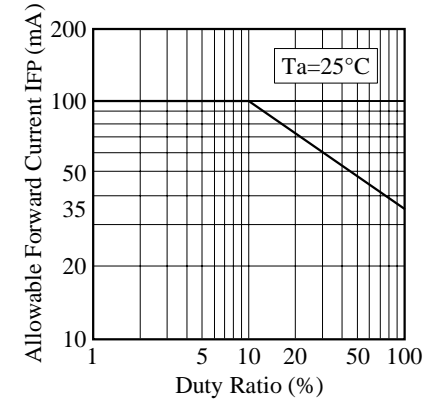

■ Ambient Temperature vs. Forward Voltage

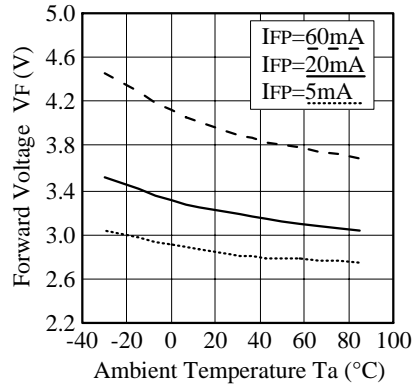

■ Ambient Temperature vs. Relative Luminosity

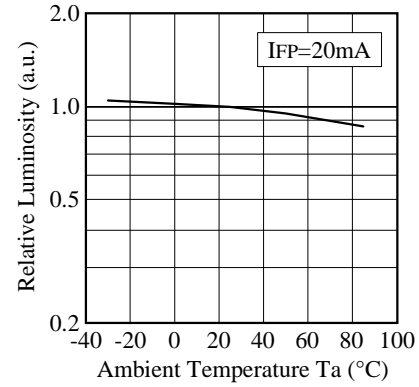

■ Ambient Temperature vs. Allowable Forward Current

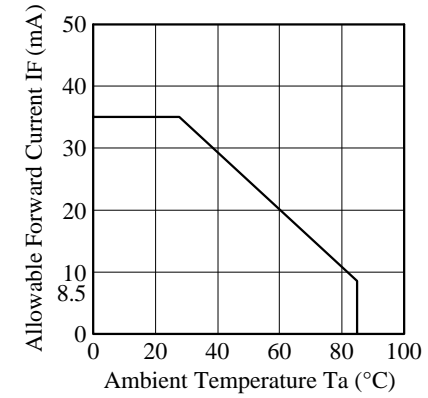

| | | |
|---------------------------|-------|-----------------|
| NICHIA CORPORATION | Model | NSSW006 |
| | Title | CHARACTERISTICS |
| | No. | 070208761421 |

■ Forward Current vs. Chromaticity Coordinate

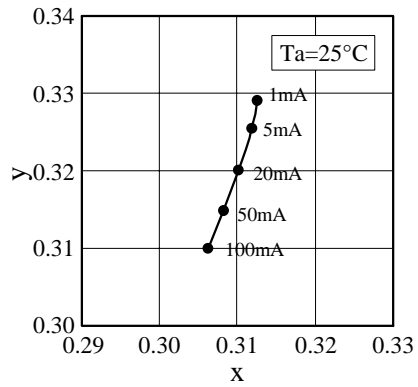

■ Spectrum

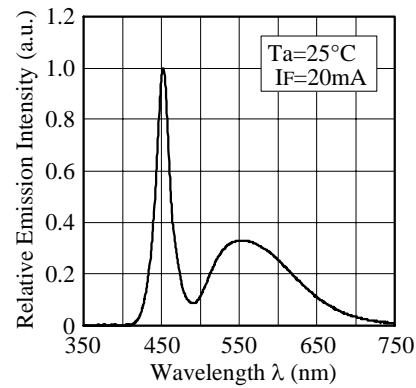

■ Ambient Temperature vs. Chromaticity Coordinate

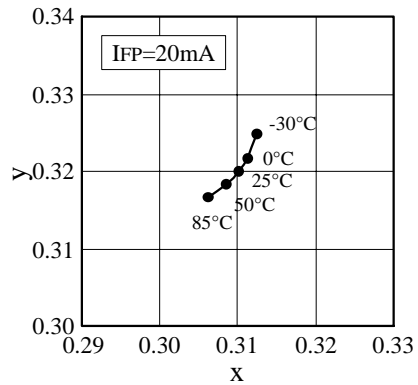

■ Directivity

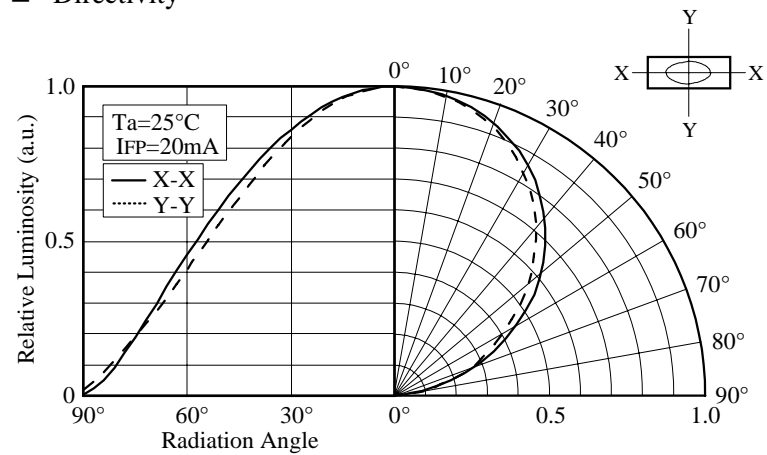

| | | |
|---------------------------|-------|-----------------|
| NICHIA CORPORATION | Model | NSSW006 |
| | Title | CHARACTERISTICS |
| | No. | 070208761431 |

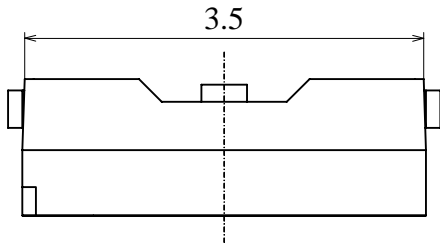

Cathode mark
C 0.12

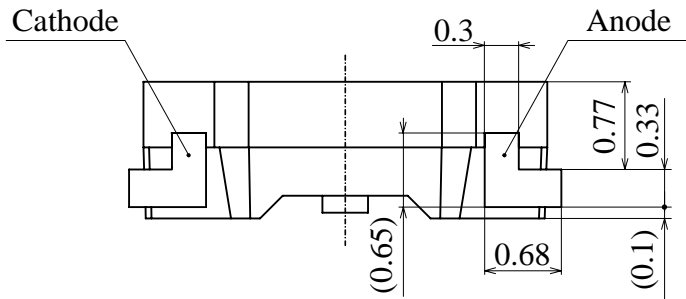
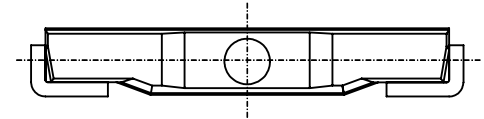
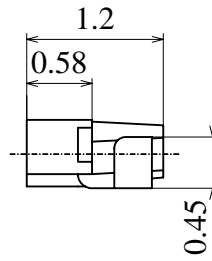
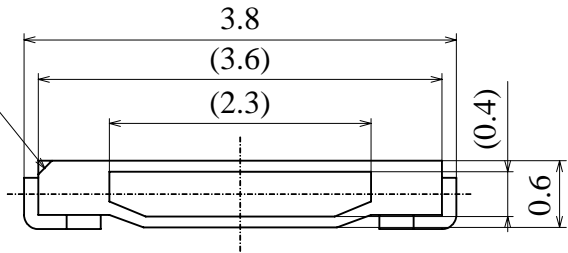

| ITEM | MATERIALS |
|---------------------|---|
| PACKAGE | Heat-Resistant Polymer |
| ENCAPSULATING RESIN | Silicone Resin (with Diffused + Phosphor) |
| ELECTRODES | Ag Plating Copper Alloy |

(NOTE) The LED may have flash/flange which exceeds the tolerance of this print.

| | | | |
|---------------------------|-------|--------------------|-----------------------------|
| NICHIA CORPORATION | Model | NSSW006 | Unit mm 15/1 Scale |
| | Title | OUTLINE DIMENSIONS | |
| | No. | 070207761211 | Allow ±0.1 |

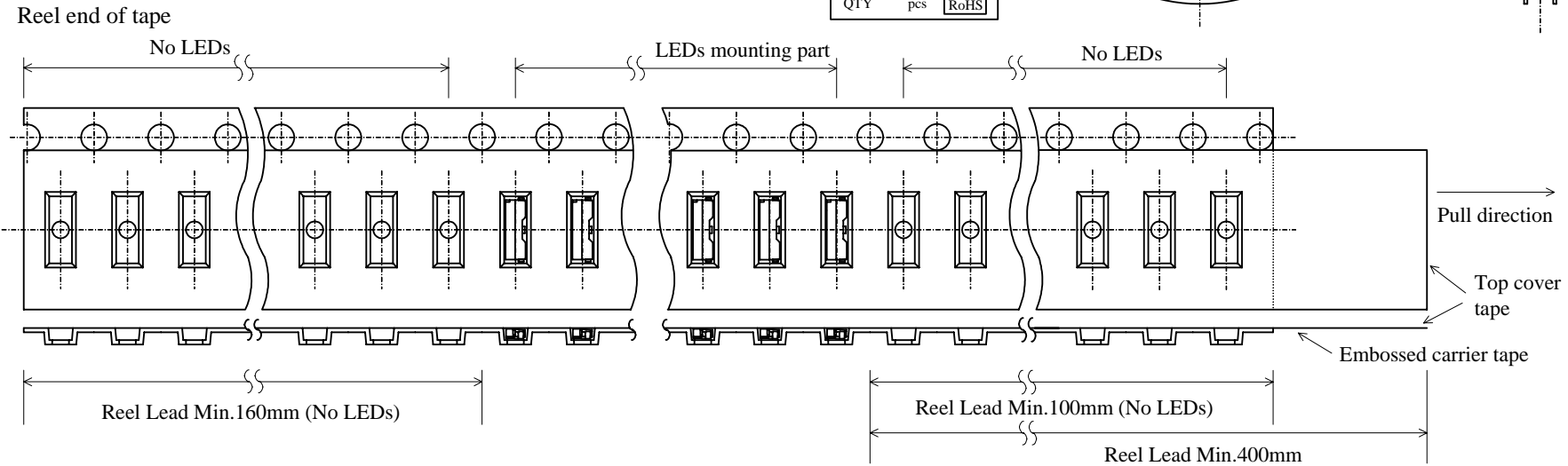
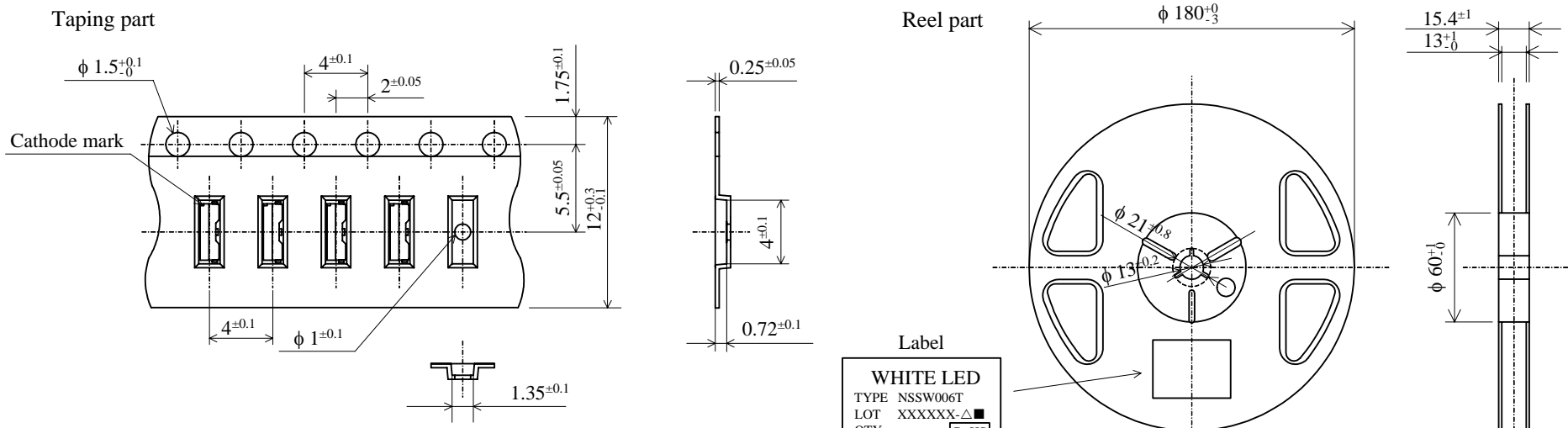

5,000pcs/Reel

Taping is based on the **JIS C 0806** : Packaging of Electronic Components on Continuous Tapes.

| | | | |
|---------------------------|-------|-------------------|----------------|
| NICHIA CORPORATION | Model | NSSW006T | Unit mm |
| | Title | TAPING DIMENSIONS | |
| | No. | 070530761222 | Scale Allow |

The reel and moisture absorbent material are put in the moisture proof foil bag and then heat sealed.

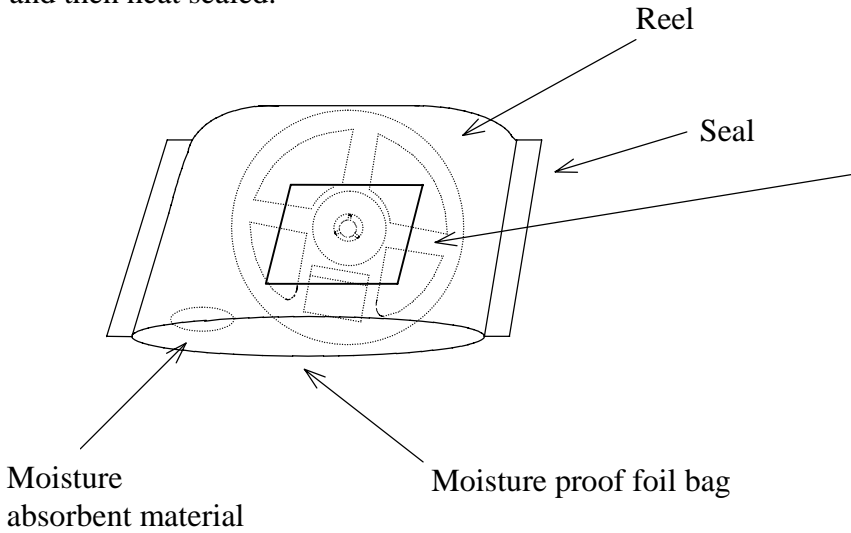

Label

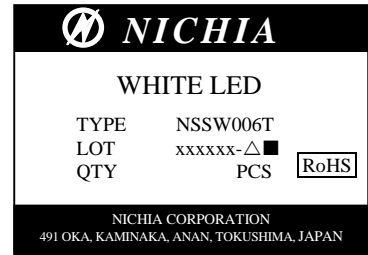

The box is partitioned with the cardboard.

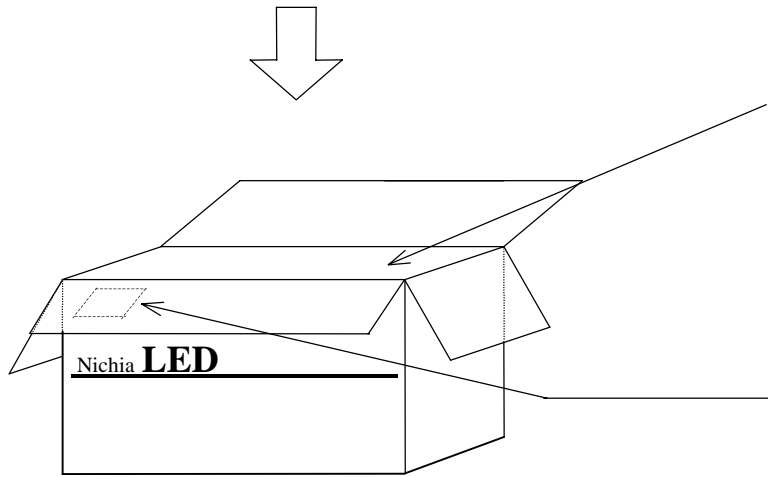

Label

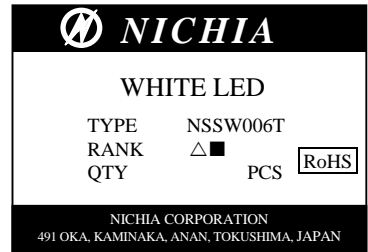

Packing unit

| | Reel/bag | Quantity/bag (pcs) |
|-------------------------|----------|--------------------|
| Moisture proof foil bag | 1reel | 5,000 MAX. |

| Cardboard box | Dimensions (mm) | Reel/box | Quantity/box (pcs) |
|-----------------|-----------------|-------------|--------------------|
| Cardboard box S | 291×237×120×8t | 5reel MAX. | 25,000 MAX. |
| Cardboard box M | 259×247×243×5t | 10reel MAX. | 50,000 MAX. |
| Cardboard box L | 444×262×259×8t | 20reel MAX. | 100,000 MAX. |

| | | | |
|---------------------------|-------|--------------|---|
| NICHIA CORPORATION | Model | NSSW006T | / |
| | Title | PACKING | |
| | No. | 070530761232 | |