

**SPECIFICATIONS FOR NICHIA CHIP TYPE WHITE LED**

**MODEL : NSCW335T**

**NICHIA CORPORATION**

## 1.SPECIFICATIONS

### (1) Absolute Maximum Ratings (Ta=25°C)

Item	Symbol	Absolute Maximum Rating	Unit
Forward Current	IF	30	mA
Pulse Forward Current	IFP	100	mA
Reverse Voltage	VR	5	V
Power Dissipation	PD	120	mW
Operating Temperature	Topr	-30 ~ + 85	°C
Storage Temperature	Tstg	-40 ~ +100	°C
Soldering Temperature	Tsld	Reflow Soldering : 260°C for 10sec. Hand Soldering : 350°C for 3sec.	

IFP Conditions : Pulse Width  $\leq$  10msec. and Duty  $\leq$  1/10

### (2) Initial Electrical/Optical Characteristics (Ta=25°C)

Item	Symbol	Condition	Min.	Typ.	Max.	Unit	
Forward Voltage	VF	IF=20[mA]	-	3.6	4.0	V	
Reverse Current	IR	VR= 5[V]	-	-	50	$\mu$ A	
Luminous Intensity	Rank T	IV	IF=20[mA]	720	860	1000	mcd
	Rank S	IV	IF=20[mA]	500	600	720	mcd
	Rank R	IV	IF=20[mA]	360	430	500	mcd

\* Luminous Intensity Measurement allowance is  $\pm$  10%.

#### Color Ranks

(IF=20mA, Ta=25°C)

	Rank a0			
x	0.280	0.264	0.283	0.296
y	0.248	0.267	0.305	0.276

	Rank b1			
x	0.287	0.283	0.330	0.330
y	0.295	0.305	0.360	0.339

	Rank b2			
x	0.296	0.287	0.330	0.330
y	0.276	0.295	0.339	0.318

	Rank c0			
x	0.330	0.330	0.361	0.356
y	0.318	0.360	0.385	0.351

\* Color Coordinates Measurement allowance is  $\pm$  0.01.

\* One delivery will include up to consecutive two color ranks and three luminous intensity ranks of the products.

The quantity-ratio of the ranks is decided by Nichia.

## 2.TYPICAL INITIAL OPTICAL/ELECTRICAL CHARACTERISTICS

Please refer to figure's page.

## 3.OUTLINE DIMENSIONS AND MATERIALS

Please refer to figure's page.

Material as follows ;      Package : Heat-Resistant Polymer  
                                          Encapsulating Resin : Silicone Resin (with Diffused + YAG Phosphor)  
                                          Electrodes : Ag Plating Copper Alloy

#### 4.PACKAGING

- The LEDs are packed in cardboard boxes after taping.

Please refer to figure's page.

The label on the minimum packing unit shows ; Part Number, Lot Number, Ranking, Quantity

- In order to protect the LEDs from mechanical shock, we pack them in cardboard boxes for transportation.
- The LEDs may be damaged if the boxes are dropped or receive a strong impact against them, so precautions must be taken to prevent any damage.
- The boxes are not water resistant and therefore must be kept away from water and moisture.
- When the LEDs are transported, we recommend that you use the same packing method as Nichia.

#### 5.LOT NUMBER

The first six digits number shows **lot number**.

The lot number is composed of the following characters;

○□×××× - △■

- - Year ( 2 for 2002, 3 for 2003 )
- - Month ( 1 for Jan., 9 for Sep., A for Oct., B for Nov. )
- ×××× - Nichia's Product Number
- △ - Ranking by Color Coordinates
- - Ranking by Luminous Intensity

## 6.RELIABILITY

### (1) TEST ITEMS AND RESULTS

Test Item	Standard Test Method	Test Conditions	Note	Number of Damaged
Resistance to Soldering Heat (Reflow Soldering)	JEITA ED-4701 300 301	Tsld=260°C, 10sec. (Pre treatment 30°C,70%,168hrs.)	2 times	0/50
Solderability (Reflow Soldering)	JEITA ED-4701 300 303	Tsld=215 ± 5°C, 3sec. (Lead Solder)	1 time over 95%	0/50
Thermal Shock	JEITA ED-4701 300 307	0°C ~ 100°C 15sec. 15sec.	20 cycles	0/50
Temperature Cycle	JEITA ED-4701 100 105	-40°C ~ 25°C ~ 100°C ~ 25°C 30min. 5min. 30min. 5min.	100 cycles	0/50
Moisture Resistance Cyclic	JEITA ED-4701 200 203	25°C ~ 65°C ~ -10°C 90%RH 24hrs./1cycle	10 cycles	0/50
High Temperature Storage	JEITA ED-4701 200 201	Ta=100°C	1000 hrs.	0/50
Temperature Humidity Storage	JEITA ED-4701 100 103	Ta=60°C, RH=90%	1000 hrs.	0/50
Low Temperature Storage	JEITA ED-4701 200 202	Ta=-40°C	1000 hrs.	0/50
Steady State Operating Life Condition 1		Ta=25°C, IF=20mA	1000 hrs.	0/50
Steady State Operating Life Condition 2		Ta=25°C, IF=30mA	500 hrs.	0/50
Steady State Operating Life of High Temperature		Ta=85°C, IF=5mA	1000 hrs.	0/50
Steady State Operating Life of High Humidity Heat		60°C, RH=90%, IF=15mA	500 hrs.	0/50
Steady State Operating Life of Low Temperature		Ta=-30°C, IF=20mA	1000 hrs.	0/50
Vibration	JEITA ED-4701 400 403	100 ~ 2000 ~ 100Hz Sweep 4min. 200m/s <sup>2</sup> 3direction, 4cycles	48min.	0/50
Substrate Bending	JEITA ED-4702	3mm, 5 ± 1 sec.	1 time	0/50
Stick	JEITA ED-4702	5N, 10 ± 1 sec.	1 time	0/50

### (2) CRITERIA FOR JUDGING THE DAMAGE

Item	Symbol	Test Conditions	Criteria for Judgement	
			Min.	Max.
Forward Voltage	V <sub>F</sub>	I <sub>F</sub> =20mA	-	U.S.L.*) × 1.1
Reverse Current	I <sub>R</sub>	V <sub>R</sub> =5V	-	U.S.L.*) × 2.0
Luminous Intensity	I <sub>V</sub>	I <sub>F</sub> =20mA	L.S.L.***) × 0.7	-

\*) U.S.L. : Upper Standard Level

\*\*) L.S.L. : Lower Standard Level

## 7.CAUTIONS

White LEDs are devices which are materialized by combining Blue LEDs and special phosphors. Consequently, the color of White LEDs is changed a little by an operating current. Care should be taken after due consideration when using LEDs.

### (1) Moisture Proof Package

- When moisture is absorbed into the SMT package it may vaporize and expand during soldering. There is a possibility that this can cause exfoliation of the contacts and damage to the optical characteristics of the LEDs. For this reason, the moisture proof package is used to keep moisture to a minimum in the package.
- The moisture proof package is made of an aluminum moisture proof bag with a zipper. A package of a moisture absorbent material (silica gel) is inserted into the aluminum moisture proof bag. The silica gel changes its color from blue to pink as it absorbs moisture.

### (2) Storage

#### · Storage Conditions

Before opening the package :

The LEDs should be kept at 30°C or less and 90%RH or less. The LEDs should be used within a year. When storing the LEDs, moisture proof packaging with absorbent material (silica gel) is recommended.

After opening the package :

The LEDs should be kept at 30°C or less and 70%RH or less. The LEDs should be soldered within 168 hours (7days) after opening the package. If unused LEDs remain, they should be stored in moisture proof packages, such as sealed containers with packages of moisture absorbent material (silica gel). It is also recommended to return the LEDs to the original moisture proof bag and to reseal the moisture proof bag again.

- If the moisture absorbent material (silica gel) has faded away or the LEDs have exceeded the storage time, baking treatment should be performed using the following conditions.  
Baking treatment : more than 24 hours at  $65 \pm 5^{\circ}\text{C}$
- Nichia LED electrode and leadframe are comprised of a silver plated copper alloy. The silver surface may be affected by environments which contain corrosive gases and so on. Please avoid conditions which may cause the LED to corrode, tarnish or discolor. This corrosion or discoloration might lower solderability or might affect on optical characteristics.
- Please avoid rapid transitions in ambient temperature, especially in high humidity environments where condensation can occur.

### (3) Heat Generation

- Thermal design of the end product is of paramount importance. Please consider the heat generation of the LED when making the system design. The coefficient of temperature increase per input electric power is affected by the thermal resistance of the circuit board and density of LED placement on the board, as well as other components. It is necessary to avoid intense heat generation and operate within the maximum ratings given in this specification.
- The operating current should be decided after considering the ambient maximum temperature of LEDs.

(4) Soldering Conditions

· The LEDs can be soldered in place using the reflow soldering method. Nichia cannot make a guarantee on the LEDs after they have been assembled using the dip soldering method.

· Recommended soldering conditions

	Reflow Soldering		Hand Soldering	
	Lead Solder	Lead-free Solder	Temperature	350°C Max.
Pre-heat	120 ~ 150°C	180 ~ 200°C	Soldering time	3 sec. Max. (one time only)
Pre-heat time	120 sec. Max.	120 sec. Max.		
Peak temperature	240°C Max.	260°C Max.		
Soldering time	10 sec. Max.	10 sec. Max.		
Condition	refer to Temperature - profile ①.	refer to Temperature - profile ②. (N <sub>2</sub> reflow is recommended.)		

\* After reflow soldering rapid cooling should be avoided.

[Temperature-profile (Surface of circuit board)]

Use the conditions shown to the under figure.

<① : Lead Solder>

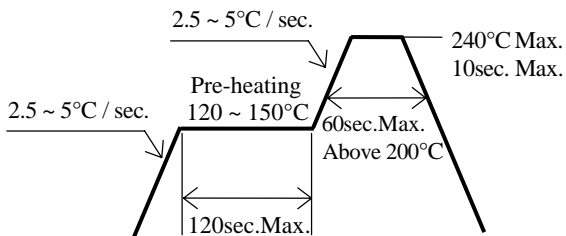

<② : Lead-free Solder>

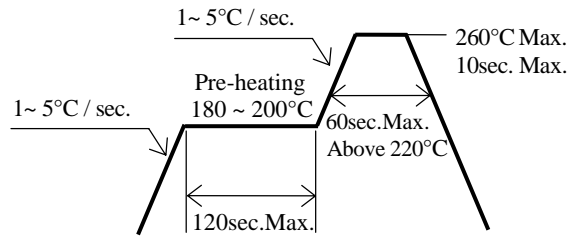

[Recommended soldering pad design]

Use the following conditions shown in the figure.

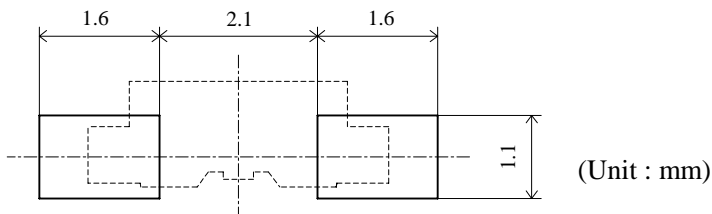

- Occasionally there is a brightness decrease caused by the influence of heat or ambient atmosphere during air reflow. It is recommended that the User use the nitrogen reflow method.
- Repairing should not be done after the LEDs have been soldered. When repairing is unavoidable, a double-head soldering iron should be used. It should be confirmed beforehand whether the characteristics of the LEDs will or will not be damaged by repairing.
- Reflow soldering should not be done more than two times.
- When soldering, do not put stress on the LEDs during heating.
- After soldering, do not warp the circuit board.

(5) Cleaning

- It is recommended that isopropyl alcohol be used as a solvent for cleaning the LEDs. When using other solvents, it should be confirmed beforehand whether the solvents will dissolve the package and the resin or not. Freon solvents should not be used to clean the LEDs because of worldwide regulations.
- Do not clean the LEDs by the ultrasonic. When it is absolutely necessary, the influence of ultrasonic cleaning on the LEDs depends on factors such as ultrasonic power and the assembled condition. Before cleaning, a pre-test should be done to confirm whether any damage to the LEDs will occur.

#### (6) Static Electricity

- Static electricity or surge voltage damages the LEDs.

It is recommended that a wrist band or an anti-electrostatic glove be used when handling the LEDs.

- All devices, equipment and machinery must be properly grounded.

It is recommended that measures be taken against surge voltage to the equipment that mounts the LEDs.

- When inspecting the final products in which LEDs were assembled, it is recommended to check whether the assembled LEDs are damaged by static electricity or not. It is easy to find static-damaged LEDs by a light-on test or a VF test at a lower current (below 1mA is recommended).
- Damaged LEDs will show some unusual characteristics such as the leak current remarkably increases, the forward voltage becomes lower, or the LEDs do not light at the low current.

Criteria : (VF > 2.0V at IF=0.5mA)

#### (7) Others

- Care must be taken to ensure that the reverse voltage will not exceed the absolute maximum rating when using the LEDs with matrix drive.
- The LED light output is strong enough to injure human eyes. Precautions must be taken to prevent looking directly at the LEDs with unaided eyes for more than a few seconds.
- Flashing lights have been known to cause discomfort in people; you can prevent this by taking precautions during use. Also, people should be cautious when using equipment that has had LEDs incorporated into it.
- The LEDs described in this brochure are intended to be used for ordinary electronic equipment (such as office equipment, communications equipment, measurement instruments and household appliances). Consult Nichia's sales staff in advance for information on the applications in which exceptional quality and reliability are required, particularly when the failure or malfunction of the LEDs may directly jeopardize life or health (such as for airplanes, aerospace, submersible repeaters, nuclear reactor control systems, automobiles, traffic control equipment, life support systems and safety devices).
- User shall not reverse engineer by disassembling or analysis of the LEDs without having prior written consent from Nichia. When defective LEDs are found, the User shall inform Nichia directly before disassembling or analysis.
- The formal specifications must be exchanged and signed by both parties before large volume purchase begins.
- The appearance and specifications of the product may be modified for improvement without notice.

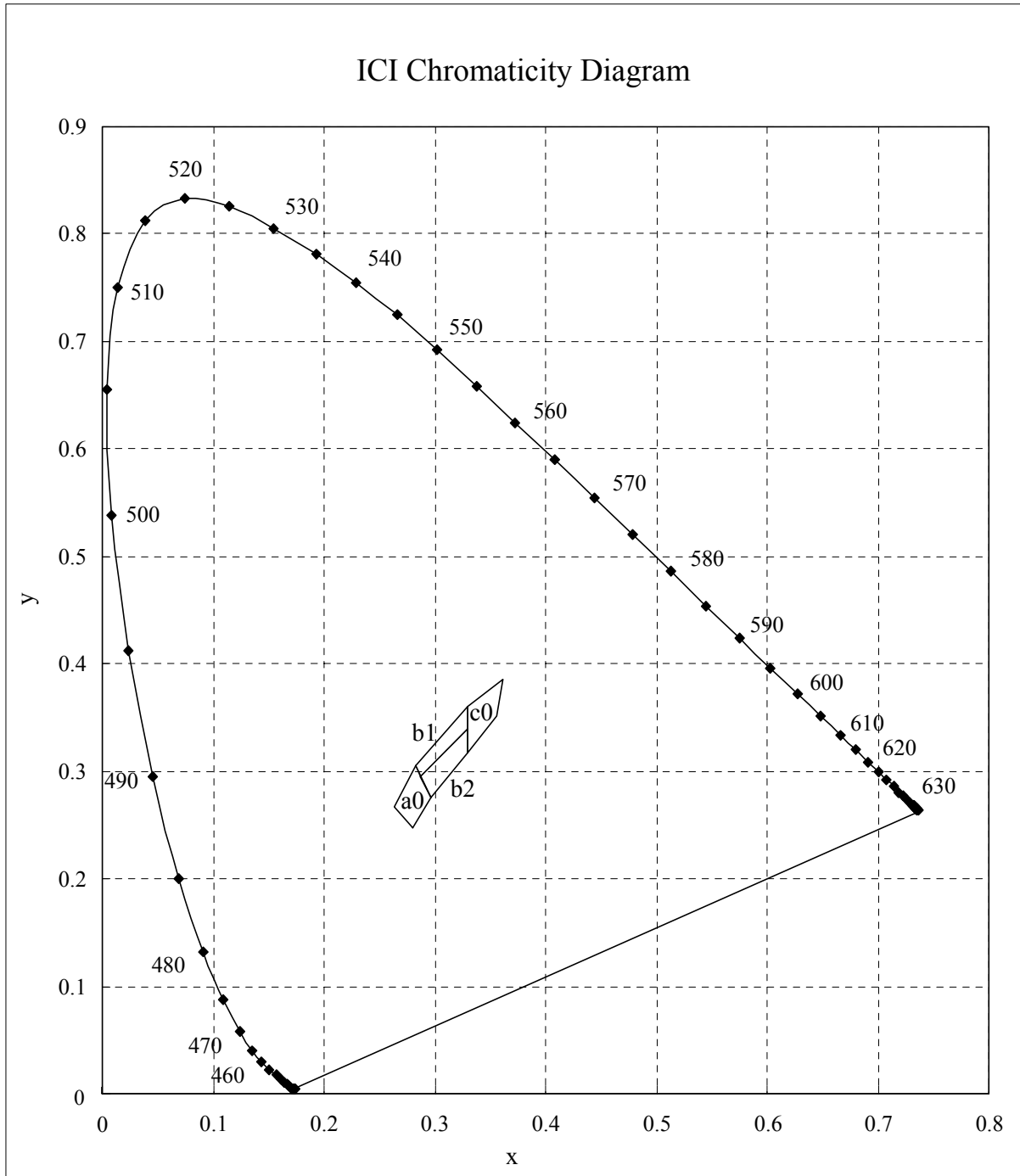

\* Color Coordinates Measurement allowance is  $\pm 0.01$ .



■ Forward Voltage vs. Forward Current

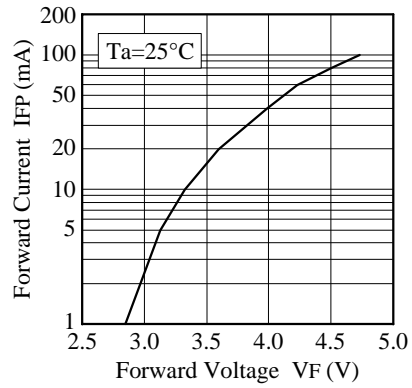

■ Forward Current vs. Relative Luminosity

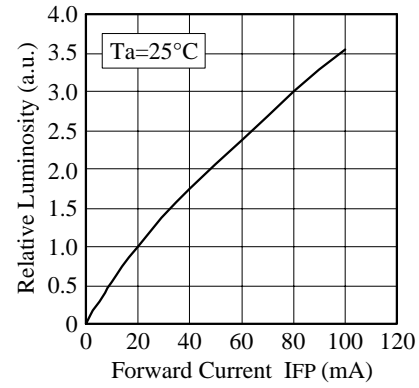

■ Duty Ratio vs. Allowable Forward Current

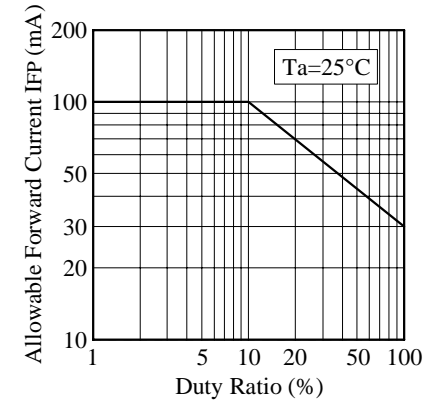

■ Ambient Temperature vs. Forward Voltage

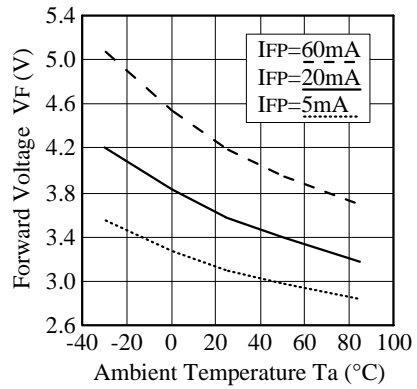

■ Ambient Temperature vs. Relative Luminosity

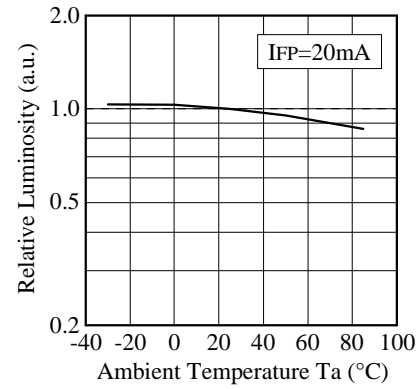

■ Ambient Temperature vs. Allowable Forward Current

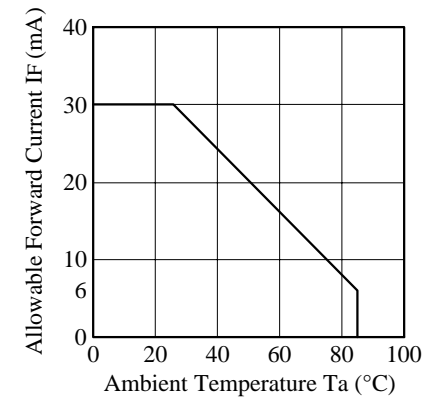

<b>NICHIA CORPORATION</b>	Model	NSCW335
	Title	TYP.CHARACTERISTICS
	No.	020220201681

■ Forward Current vs. Chromaticity diagram

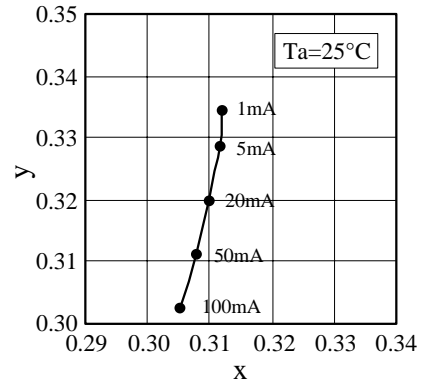

■ Spectrum

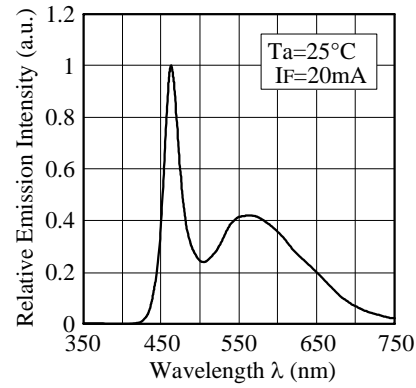

■ Ambient Temperature vs. Chromaticity diagram

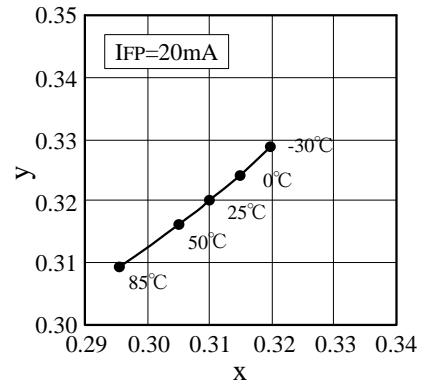

■ Directivity (NSCW335)

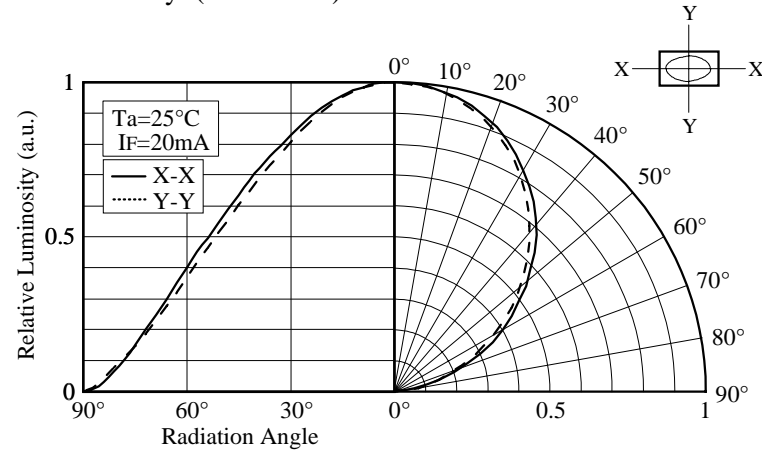

<b>NICHIA CORPORATION</b>	Model	NSCW335
	Title	TYP.CHARACTERISTICS
	No.	020220201691

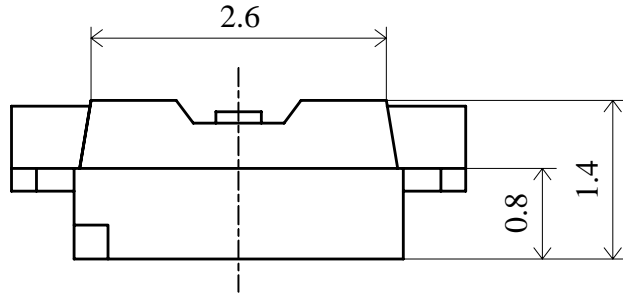

Cathode mark  
C 0.3

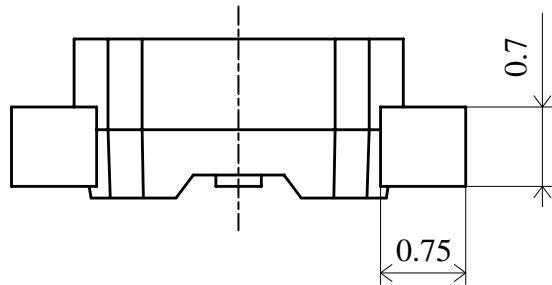
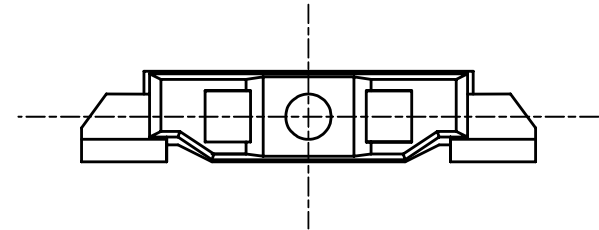
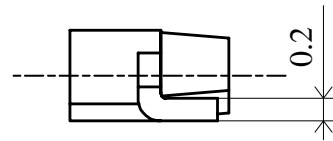
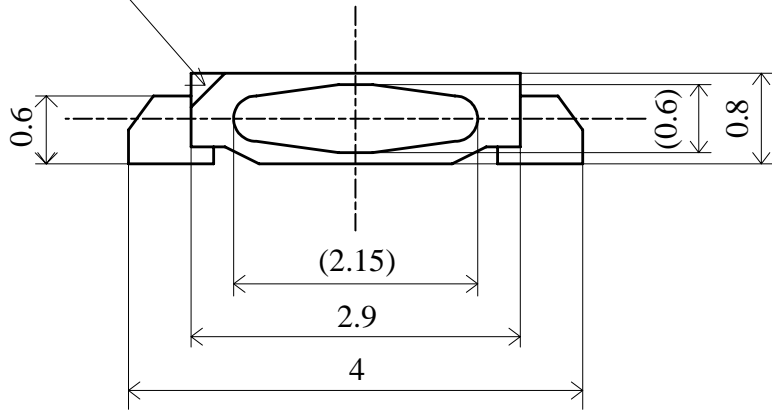

ITEM	MATERIALS
PACKAGE	Heat-Resistant Polymer
ENCAPSULATING RESIN	Silicone Resin (with Diffused + YAG Phosphor)
ELECTRODES	Ag Plating Copper Alloy

(NOTE) The LED may have flash/flange which exceeds the tolerance of this print.

NICHIA CORPORATION	Model	NSCW335	Unit mm
	Title	OUTLINE DIMENSIONS	
	No.	03924312562	Allow ±0.1

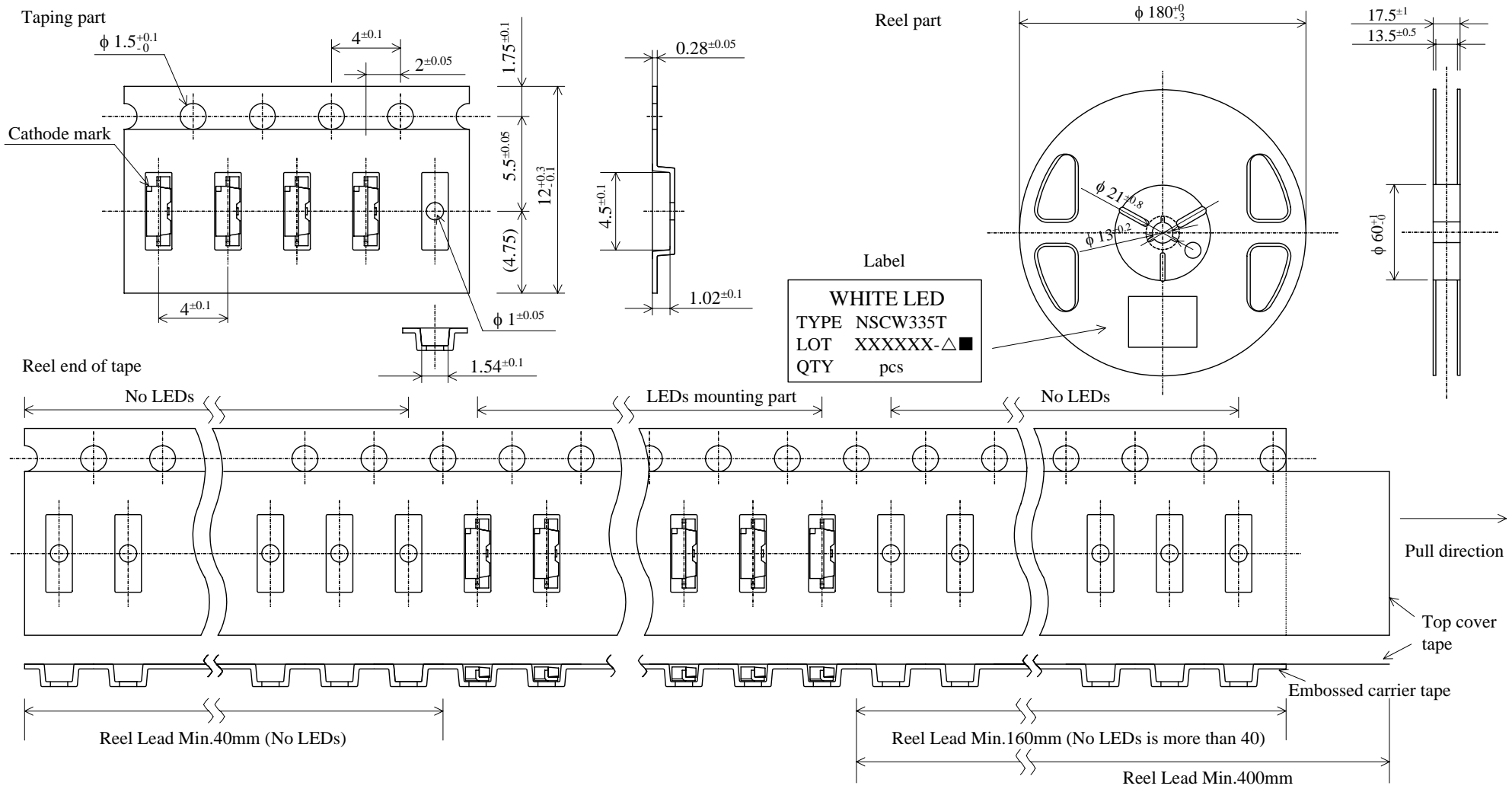

3,500pcs/Reel

Taping is based on the **JIS C 0806** : Packaging of Electronic Components on Continuous Tapes.

<b>NICHIA CORPORATION</b>	Model	NSCW335	Unit mm
	Title	TAPING DIMENSIONS	
	No.	030917309352	Scale Allow

The reel and moisture absorbent material are put in the moisture proof foil bag and then heat sealed.

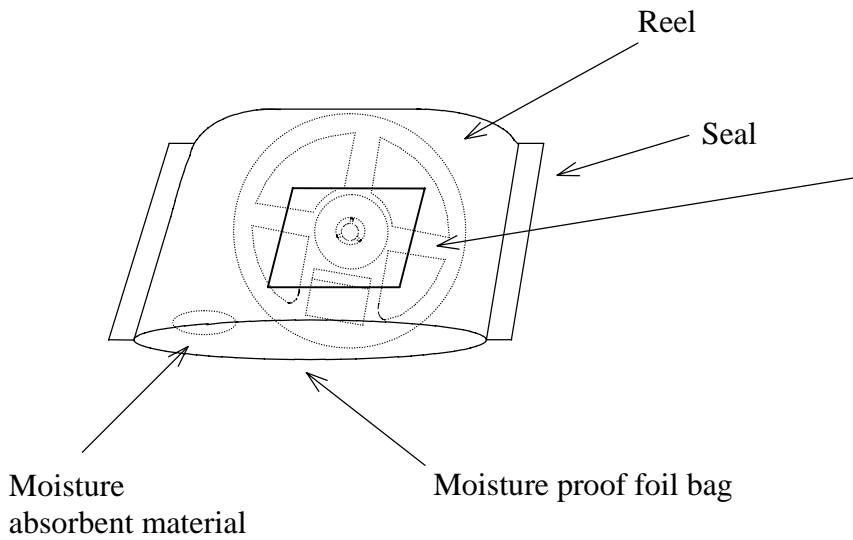

Label

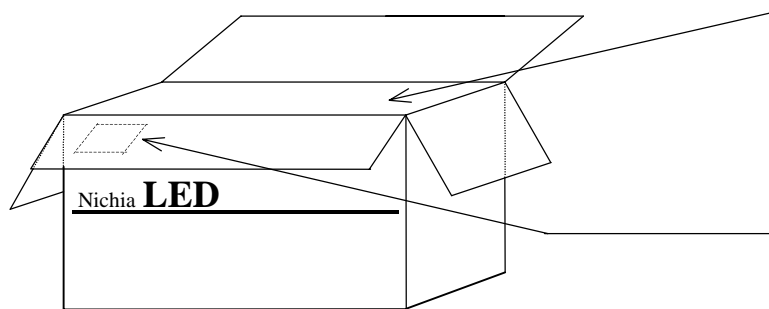
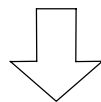

Empty space in the box is filled with cushion material.

Label

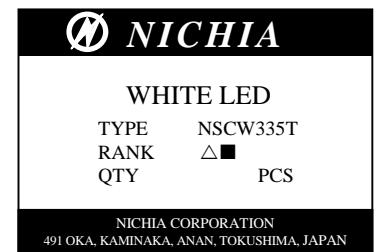

Packing unit

	Reel/bag	Quantity/bag (pcs)
Moisture proof foil bag	1reel	3,500 MAX.

Cardboard box	Dimensions (mm)	Reel/box	Quantity/box (pcs)
Cardboard box S	270×280×100×4t	4reel MAX.	14,000 MAX.
Cardboard box M	270×280×200×4t	10reel MAX.	35,000 MAX.
Cardboard box L	270×280×300×4t	16reel MAX.	56,000 MAX.

<b>NICHIA CORPORATION</b>	Model	NSCW335T	/
	Title	PACKING	
	No.	030820313931	