

UNCONTROLLED DOCUMENT

PART NUMBER		REV.
SML-LX2832YGC-TR		A
REV.	E.C.N. NUMBER AND REVISION COMMENTS	DATE
A	E.C.N. #10967.	3.14.03

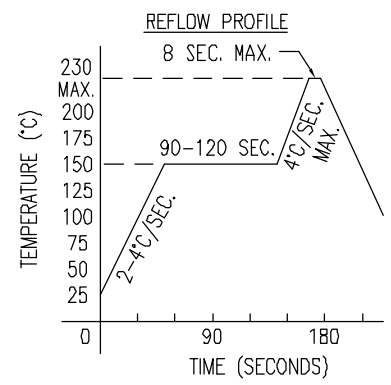

RECOMMENDED SOLDER PAD LAYOUT

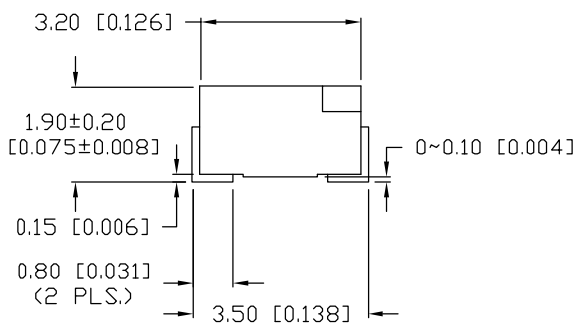
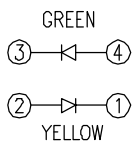
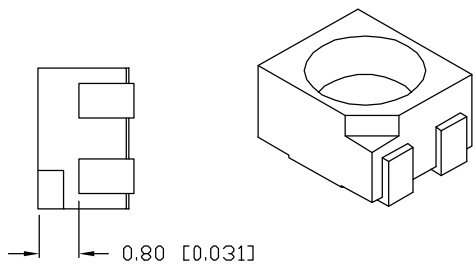
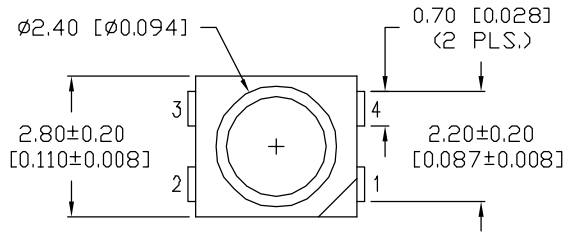
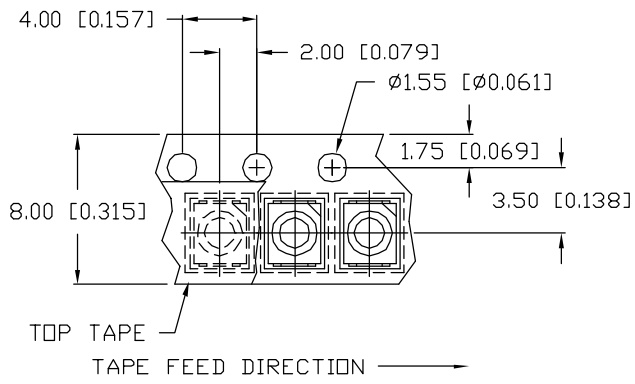
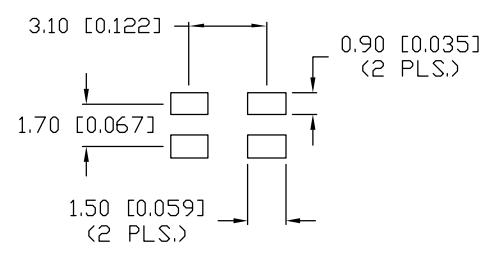

ELECTRO-OPTICAL CHARACTERISTICS $T_A=25^{\circ}\text{C}$ $I_f=20\text{mA}$

PARAMETER	MIN	TYP	MAX	UNITS	TEST COND
PEAK WAVELENGTH		585 (YELLOW)		nm	
		565 (GREEN)		nm	
FORWARD VOLTAGE		2.1/2.2	2.5/2.6	V_f	
REVERSE VOLTAGE	5.0			V_r	$I_r=100\mu\text{A}$
AXIAL INTENSITY (Y/G)		15/25		mcd	$I_f=20\text{mA}$
VIEWING ANGLE		120		2x theta	
EMITTED COLOR:	YELLOW/GREEN				
EPOXY LENS FINISH:	WATER CLEAR				

LIMITS OF SAFE OPERATION AT 25°C PER CHIP

PARAMETER	COLORS	MAX	UNITS
PEAK FORWARD CURRENT*		160	mA
STEADY CURRENT	(Y/G)	30/25	mA
POWER DISSIPATION		100	mW
DERATE FROM 25°C		-1.2	mW/°C
OPERATING TEMP.		-25 TO +85	°C
STORAGE TEMP.		-30 TO +85	°C

* $t < 10\mu\text{S}$

NOTES:

1. THE POLARITY MARK IS ORIENTED TOWARDS THE TAPE SPROCKET HOLE.

CAUTION: MOISTURE SENSITIVE DEVICE
PER JEDEC LEVEL 4 STANDARDS

REPLACES PART #: SML-LX2832YGC(-TR)

*UNLESS OTHERWISE SPECIFIED TOLERANCES PER DECIMAL PRECISION ARE: X=±1 (±0.039), X.X=±0.5 (±0.020), X.XX=±0.25 (±0.010), X.XXX=±0.127 (±0.005). LEAD SIZE=±0.05 (±0.002), LEAD LENGTH=±0.75 (±0.030). MIN.=+DECIMAL PRECISION MAX.=+0.00 -DECIMAL PRECISION

UNCONTROLLED DOCUMENT

REV.	PART NUMBER
A	SML-LX2832YGC-TR
2.8mm x 3.2mm SURFACE MOUNT WITH REFLECTOR CUP, DUAL CHIP, 585nm YELLOW LED AND 565nm GREEN LED, WATER CLEAR LENS, 2k PER REEL.	

CONFIDENTIAL INFORMATION
THE INFORMATION CONTAINED IN THIS DOCUMENT IS THE PROPERTY OF LUMEX INC. EXCEPT AS SPECIFICALLY AUTHORIZED IN WRITING BY LUMEX INC., THE HOLDER OF THIS DOCUMENT SHALL KEEP ALL INFORMATION CONTAINED HEREIN CONFIDENTIAL AND SHALL PROTECT SAME IN WHOLE OR IN PART FROM DISCLOSURE AND DISSEMINATION TO ALL THIRD PARTIES.

RELIABILITY NOTE
OUR MANY YEARS OF EXPERIENCE DATA ACCUMULATION INDICATE THAT SOLDER HEAT IS A MAJOR CAUSE OF EARLY AND FUTURE FAILURE. PLEASE PAY ATTENTION TO YOUR SOLDERING PROCESS.

LUMEX INCORPORATED		290 E. HELLEN ROAD PALATINE, ILLINOIS 60067 PHONE: (847) 359-2790 WEB: http://www.lumex.com	
DRAWN BY:	CHECKED BY:	APPROVED BY:	DATE: 12.11.00
BC			PAGE: 1 OF 1
			SCALE: N/A