

UNCONTROLLED DOCUMENT

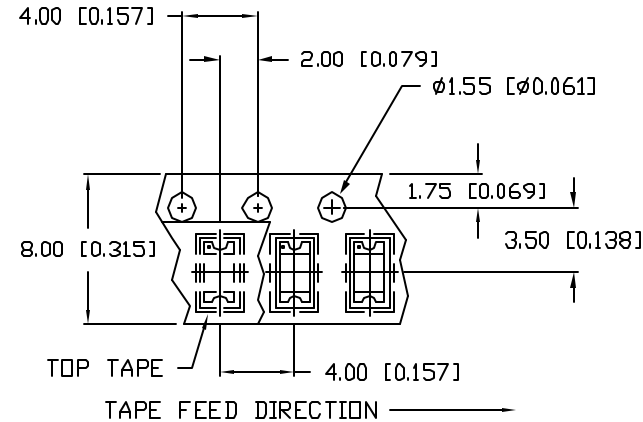

CAUTION: STATIC SENSITIVE DEVICE  
FOLLOW PROPER E.S.D. HANDLING PROCEDURES  
WHEN WORKING WITH THIS PART.

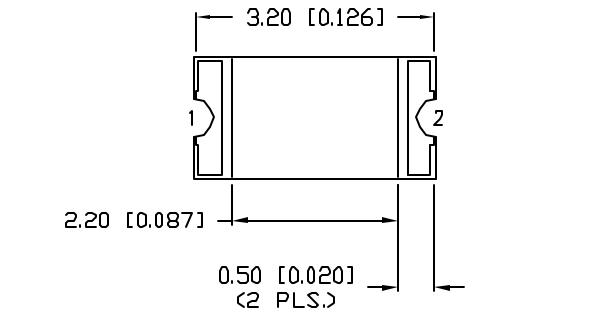
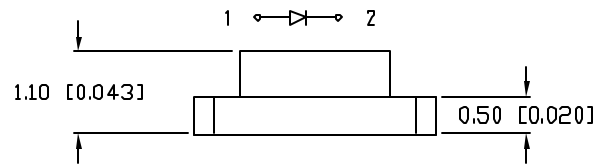
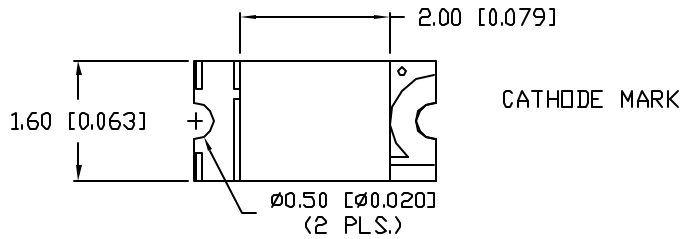
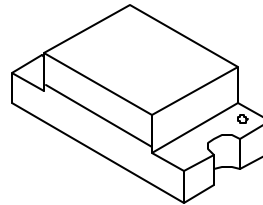

LEAD FREE REFLOW PROFILE  
10 SEC. MAX.

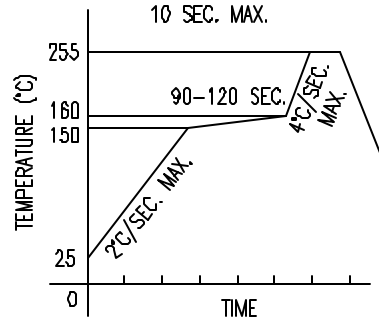

TOTAL TIME ABOVE 220°C IS 60 SECONDS MAX.

RECOMMENDED SOLDER PAD LAYOUT

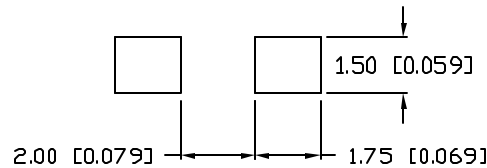

PART NUMBER  
SML-LX1206UWW-TR

REV.  
B

REV.	E.C.N. NUMBER AND REVISION COMMENTS	DATE
A	E.C.N. #10967.	3.14.03
B	E.C.N. #11148.	1.20.05

ELECTRO-OPTICAL CHARACTERISTICS  $T_A=25^\circ\text{C}$

PARAMETER	SYMBOL	MIN	TYP	MAX	UNITS	TEST COND
PEAK WAVELENGTH			550		nm	
FORWARD VOLTAGE	$V_f$		3.5	4.0	V	$I_f=20\text{mA}$
REVERSE VOLTAGE	$V_r$	5			V	$I_r=10\mu\text{A}$
AXIAL INTENSITY(*1)	$I_v$		90		msd	$I_f=20\text{mA}$
CHROMATICITY	X		0.31			
COORDINATES(*2)	Y		0.33			
VIEWING ANGLE			140		2x theta	
EMITTED COLOR:			WHITE			
EPOXY LENS FINISH:			YELLOW DIFFUSED			

\*1. AXIAL INTENSITY TESTING CONDITION: 550nm WAVELENGTH.  
\*2. THE ICI STANDARD COLORIMETRIC SYSTEM.

LIMITS OF SAFE OPERATION AT 25°C

PARAMETER	MAX	UNITS
PEAK FORWARD CURRENT*	80	mA
STEADY CURRENT	30	mA
POWER DISSIPATION	70	mW
DERATE FROM 25°C	-1.2	mW/°C
OPERATING TEMP.	-25 TO +85	°C
STORAGE TEMP.	-25 TO +85	°C

NOTES:

1. THE POLARITY MARK IS ORIENTED TOWARDS THE TAPE SPROCKET HOLE.

CAUTION: MOISTURE SENSITIVE DEVICE  
PER JEDEC LEVEL 4 STANDARDS

UNCONTROLLED DOCUMENT

\*UNLESS OTHERWISE SPECIFIED TOLERANCES PER DECIMAL PRECISION ARE: X=±1 (±0.039), XX=±0.5 (±0.020), XXX=±0.25 (±0.010), XXXX=±0.127 (±0.005). LEAD SIZE=±0.05 (0.002), LEAD LENGTH=±0.75 (±0.030), MIN.= +DECIMAL PRECISION -0.00, MAX.= +0.00 -DECIMAL PRECISION

REV. B PART NUMBER SML-LX1206UWW-TR

3.2mm x 1.6mm PCB SURFACE MOUNT LED,  
ULTRA WHITE LED,  
YELLOW DIFFUSED LENS, TAPE AND REEL.

CONFIDENTIAL INFORMATION  
THE INFORMATION CONTAINED IN THIS DOCUMENT IS THE PROPERTY OF LUMEX INC. EXCEPT AS SPECIFICALLY AUTHORIZED IN WRITING BY LUMEX INC., THE HOLDER OF THIS DOCUMENT SHALL KEEP ALL INFORMATION CONTAINED HEREIN CONFIDENTIAL AND SHALL PROTECT SAME IN WHOLE OR IN PART FROM DISCLOSURE AND DISSEMINATION TO ALL THIRD PARTIES.

RELIABILITY NOTE  
OUR MANY YEARS OF EXPERIENCE DATA ACCUMULATION INDICATE THAT SOLDER HEAT IS A MAJOR CAUSE OF EARLY AND FUTURE FAILURE. PLEASE PAY ATTENTION TO YOUR SOLDERING PROCESS.

LUMEX  
290 E. HELEN ROAD  
PALATINE, IL 60067-6976  
PHONE: +1.847.359.2790  
US WEB: www.lumex.com  
TW WEB: www.lumex.com.tw

DRAWN BY: CT CHECKED BY: APPROVED BY: DATE: 2.10.03  
PAGE: 1 OF 1  
SCALE: N/A