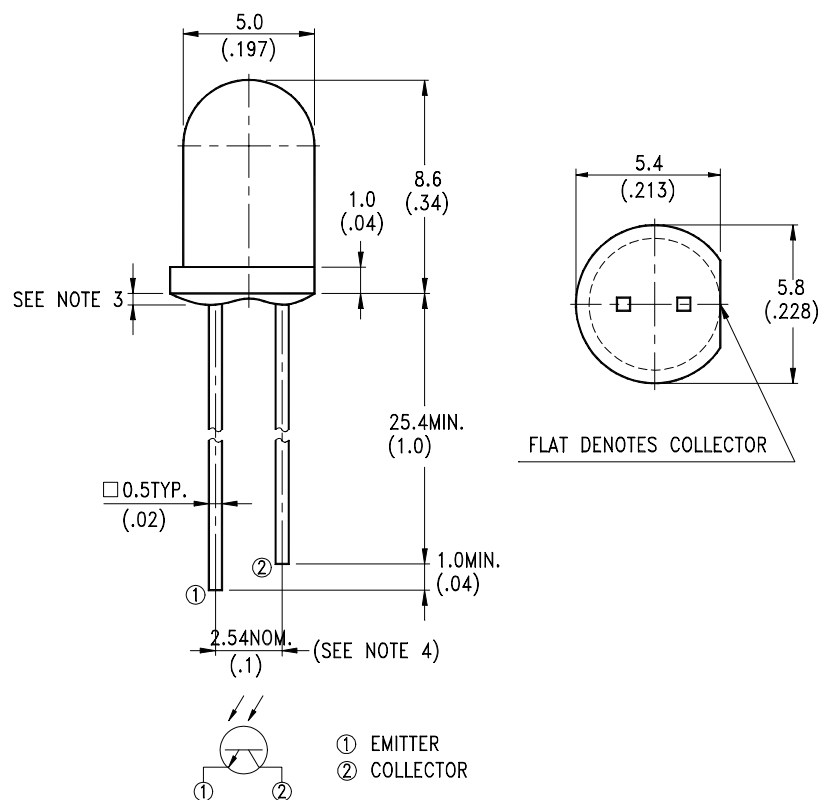

FEATURES

- * WIDE RANGE OF COLLECTOR CURRENT
- * THE LENS IS FOR HIGH SENSITIVITY
- * LOW COST PLASTIC PACKAGE
- * THE LTR-3208EL IS A SPECIAL DARK PLASTIC PACKAGE THAT CUT THE VISIBLE LIGHT AND SUITABLE FOR THE DETECTORS OF INFRARED APPLICATIONS

PACKAGE DIMENSIONS**NOTES:**

1. All dimensions are in millimeters (inches).
2. Tolerance is $\pm 0.25\text{mm}(.010\text{'})$ unless otherwise noted.
3. Protruded resin under flange is 1.5mm(.059") max.
4. Lead spacing is measured where the leads emerge from the package.
5. Specifications are subject to change without notice.

**ABSOLUTE MAXIMUM RATINGS AT TA=25°C**

PARAMETER	MAXIMUM RATING	UNIT
Power Dissipation	100	mW
Collector-Emitter Voltage	30	V
Emitter-Collector Voltage	5	V
Operating Temperature Range	-40°C to + 85°C	
Storage Temperature Range	-55°C to + 100°C	
Lead Soldering Temperature [1.6mm(.063") From Body]	260°C for 5 Seconds	

ELECTRICAL / OPTICAL CHARACTERISTICS AT TA=25°C

PARAMETER	SYMBOL	MIN.	TYP.	MAX	UNIT	TEST CONDITION	BIN NO.
Collector-Emitter Breakdown Voltage	$V_{(BR)CEO}$	30			V	$I_C = 1mA$ $E_e = 0mW/cm^2$	
Emitter-Collector Breakdown Voltage	$V_{(BR)ECO}$	5			V	$I_E = 100 \mu A$ $E_e = 0mW/cm^2$	
Collector Emitter Saturation Voltage	$V_{CE(SAT)}$		0.1	0.4	V	$I_C = 100 \mu A$ $E_e = 1mW/cm^2$	
Rise Time	T_r		10		μs	$V_{CC} = 5V$ $I_C = 1mA$ $R_L = 1K\Omega$	
Fall Time	T_f		15		μs		
Collector Dark Current	I_{CEO}			100	nA	$V_{CE} = 10V$ $E_e = 0mW/cm^2$	
On State Collector Current	$I_{C(ON)}$	0.64		1.68	mA	$V_{CE} = 5V$ $E_e = 1mW/cm^2$ $\lambda = 940nm$	BIN A
		1.12		2.16			BIN B
		1.44		2.64			BIN C
		1.76		3.12			BIN D
		2.08		3.60			BIN E
		2.40					BIN F

TYPICAL ELECTRICAL / OPTICAL CHARACTERISTICS CURVES

(25°C Ambient Temperature Unless Otherwise Noted)

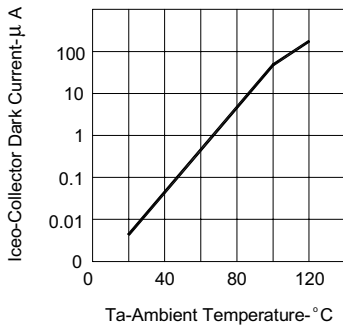

FIG.1 COLLECTOR DARK CURRENT VS AMBIENT TEMPERATURE

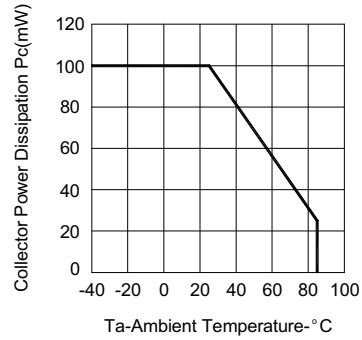

FIG.2 COLLECTOR POWER DISSIPATION VS AMBIENT TEMPERATURE

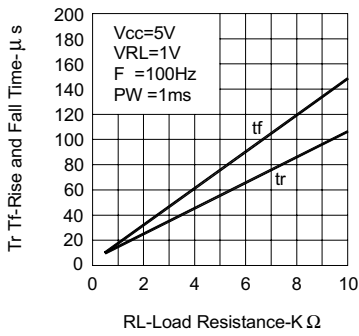

FIG.3 RISE AND FALL TIME VS LOAD RESISTANCE

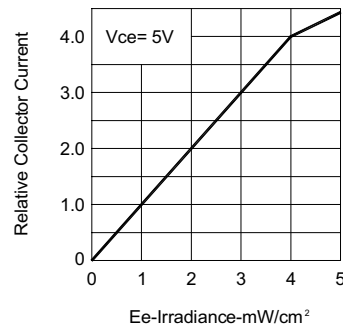

FIG.4 RELATIVE COLLECTOR CURRENT VS IRRADIANCE

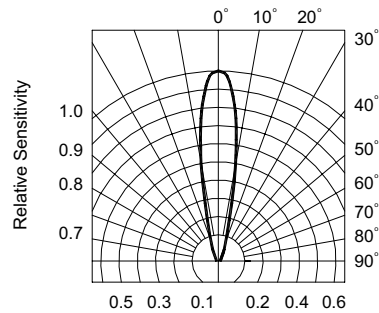
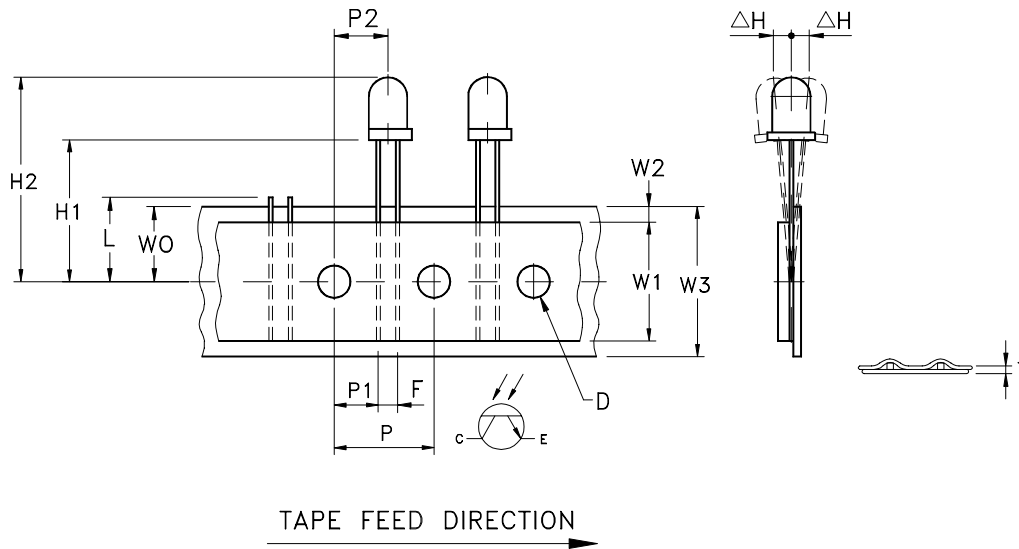

FIG.5 SENSITIVITY DIAGRAM

PACKAGE DIMENSIONS



I T E M	SYMBOL	SPECIFICATION			
		MINIMUM		MAXIMUM	
		MM	INCH	MM	INCH
Tape Feed Hole Diameter	D	3.8	0.149	4.2	0.165
Component Lead Pitch	F	2.3	0.019	3.0	0.118
Front To Rear Deflection	ΔH	--	--	2.0	0.078
Feed Hole To Bottom Of Component	H1	19.8	0.780	21.5	0.846
Feed Hole To Overall Component Height	H2	--	--	32.0	1.259
Lead Length After Component Height	L	W0		11.0	0.433
Feed Hole Pitch	P	12.4	0.488	13.0	0.511
Lead Location	P1	4.4	0.173	5.8	0.228
Center Of Component Location	P2	5.05	0.198	7.65	0.301
Total Tape Thickness	T	--	--	0.90	0.035
Feed Hole Location	W0	8.5	0.334	9.75	0.384
Adhesive Tape Width	W1	12.5	0.492	13.5	0.531
Adhesive Tape Position	W2	0	0	3.0	0.118
Tape Width	W3	17.5	0.689	19.0	0.748