

Distributed by:

**JAMECO**<sup>®</sup>  
ELECTRONICS

**www.Jameco.com ♦ 1-800-831-4242**

The content and copyrights of the attached  
material are the property of its owner.

Jameco Part Number 2005382

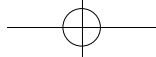

# 0.4" Alphanumeric LED Displays

## LTP-4323/4823 Series

### Features

- 0.4 inch (10.0mm) digit height.
- Continuous uniform Segments.
- Low power requirements.
- Excellent characters and appearance.
- Wide viewing angle.
- Solid state reliability.
- Common anode or common cathode models.
- Categorized for luminous intensity.
- Easy mounting on P.C. board.

### Description

The LTP-4323/4823 series are 0.4 inch (10.0mm) height 16-segment dual digit alphanumeric displays. The displays have gray face and white segments.

The AlGaAs red alphanumeric display are designed for applications requiring low power consumption. They are tested and selected for their excellent low current characteristics to ensure that the segments are matched at low current. Drive current as low as 1 mA per segment is available.

The AlGaAs red series device utilize LED chips which are made from AlGaAs on a non-transparent GaAs substrate. The bright red and green series devices utilize LED chips which are made from GaP on a transparent GaP substrate. The yellow and red orange series devices utilize LED chips which are made from GaAsP on a transparent GaP substrate.

### Package Dimensions

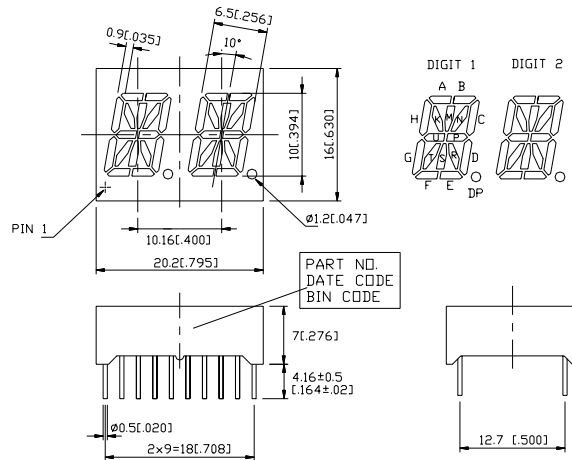

Notes: All dimensions are in millimeters (inches).  
Tolerance:  $\pm 0.25\text{mm}$  (0.010") unless otherwise noted.

### Devices

Part No.					Description	Internal Circuit Diagram
AlGaAs Red	Bright Red	Green	Yellow	Red Orange		
LTP-4323WC	LTP-4323P	LTP-4323G	LTP-4323Y	LTP-4323E	Duplex Common Cathode, Rt. Hand Decimal	A
LTP-4823WC	LTP-4823P	LTP-4823G	LTP-4823Y	LTP-4823E	Duplex Common Anode, Rt. Hand Decimal	B

### Internal Circuit Diagrams

A. LTP-4323

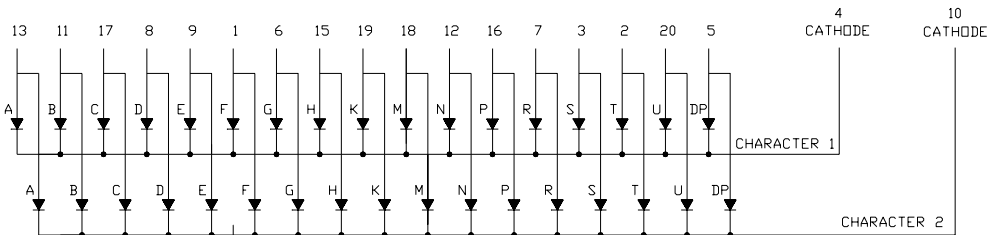

B. LTP-4823

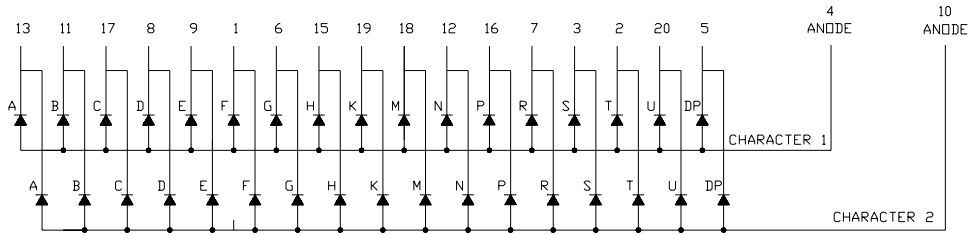

Pin Connection

Pin No.	Connection	
	A. LTP-4323	B. LTP-4823
1	Anode F	Cathode F
2	Anode T	Cathode T
3	Anode S	Cathode S
4	Common Cathode Character 1	Common Anode Character 1
5	Anode DP	Cathode DP
6	Anode G	Cathode G
7	Anode R	Cathode R
8	Anode D	Cathode D
9	Anode E	Cathode E
10	Common Cathode Character 2	Common Anode Character 2
11	Anode B	Cathode B
12	Anode N	Cathode N
13	Anode A	Cathode A
14	No Connection	No Connection
15	Anode H	Cathode H
16	Anode P	Cathode P
17	Anode C	Cathode C
18	Anode M	Cathode M
19	Anode K	Cathode K
20	Anode U	Cathode U

Absolute Maximum Rating at Ta=25°C

Parameter	AlGaAs Red	Bright Red	Green	Yellow	Red Orange	Unit
Average Power Dissipation Per Segment	75	40	75	60	75	mW
Peak Forward Current Per Segment (1/10 Duty Cycle, 0.1 ms Pulse Width)	125	60	100	80	100	mA
Average Forward Current Per Segment Derating Linear from 25°C Per Segment	30 0.4	15 0.20	25 0.33	20 0.27	25 0.33	mA mA/°C
Reverse Voltage Per Segment	5	5	5	5	5	V
Operating Temperature Range	-35°C to +85°C					
Storage Temperature Range	-35°C to +85°C					
Solder Temperature 1/16 Inch Below Seating Plane for 3 Seconds at 260°C						



## Electrical / Optical Characteristics at Ta=25°C

LTP-4323WC/4823WC

Parameter	Symbol	Min.	Typ.	Max.	Unit	Test Condition
Average Luminous Intensity	I <sub>v</sub>	200	485		μ cd	I <sub>F</sub> =1mA
			3400			I <sub>F</sub> =5mA
Peak Emission Wavelength	λ <sub>P</sub>		660		nm	I <sub>F</sub> =20mA
Spectral Line Half-Width	Δλ		35		nm	I <sub>F</sub> =20mA
Dominant Wavelength	λ <sub>d</sub>		638		nm	I <sub>F</sub> =20mA
Forward Voltage, and Segment	V <sub>F</sub>		1.6	2.4	V	I <sub>F</sub> =1mA
			1.7			I <sub>F</sub> =5mA
			1.8			I <sub>F</sub> =20mA
Reverse Current, and Segment	I <sub>R</sub>			100	μ A	V <sub>R</sub> =5V
Luminous Intensity Matching Ratio	I <sub>v</sub> -m			2:1		I <sub>F</sub> =1mA

LTP-4323P/4823P

Parameter	Symbol	Min.	Typ.	Max.	Unit	Test Condition
Average Luminous Intensity	I <sub>v</sub>	320	750		μ cd	I <sub>F</sub> =10mA
Peak Emission Wavelength	λ <sub>P</sub>		697		nm	I <sub>F</sub> =20mA
Spectral Line Half-Width	Δλ		90		nm	I <sub>F</sub> =20mA
Dominant Wavelength	λ <sub>d</sub>		657		nm	I <sub>F</sub> =20mA
Forward Voltage, and Segment	V <sub>F</sub>		2.1	2.6	V	I <sub>F</sub> =20mA
Reverse Current, and Segment	I <sub>R</sub>			100	μ A	V <sub>R</sub> =5V
Luminous Intensity Matching Ratio	I <sub>v</sub> -m			2:1		I <sub>F</sub> =10mA

LTP-4323G/4823G

Parameter	Symbol	Min.	Typ.	Max.	Unit	Test Condition
Average Luminous Intensity	I <sub>v</sub>	800	2000		μ cd	I <sub>F</sub> =10mA
Peak Emission Wavelength	λ <sub>P</sub>		565		nm	I <sub>F</sub> =20mA
Spectral Line Half-Width	Δλ		30		nm	I <sub>F</sub> =20mA
Dominant Wavelength	λ <sub>d</sub>		569		nm	I <sub>F</sub> =20mA
Forward Voltage, and Segment	V <sub>F</sub>		2.1	2.6	V	I <sub>F</sub> =20mA
Reverse Current, and Segment	I <sub>R</sub>			100	μ A	V <sub>R</sub> =5V
Luminous Intensity Matching Ratio	I <sub>v</sub> -m			2:1		I <sub>F</sub> =10mA

LTP-4323Y/4823Y

Parameter	Symbol	Min.	Typ.	Max.	Unit	Test Condition
Average Luminous Intensity	I <sub>v</sub>	800	2000		μ cd	I <sub>F</sub> =10mA
Peak Emission Wavelength	λ <sub>P</sub>		585		nm	I <sub>F</sub> =20mA
Spectral Line Half-Width	Δλ		35		nm	I <sub>F</sub> =20mA
Dominant Wavelength	λ <sub>d</sub>		588		nm	I <sub>F</sub> =20mA
Forward Voltage, and Segment	V <sub>F</sub>		2.1	2.6	V	I <sub>F</sub> =20mA
Reverse Current, and Segment	I <sub>R</sub>			100	μ A	V <sub>R</sub> =5V
Luminous Intensity Matching Ratio	I <sub>v</sub> -m			2:1		I <sub>F</sub> =10mA

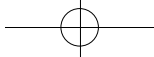

LTP-4323E/4823E

Parameter	Symbol	Min.	Typ.	Max.	Unit	Test Condition
Average Luminous Intensity	I <sub>v</sub>	800	2000		μ cd	I <sub>F</sub> =10mA
Peak Emission Wavelength	λ <sub>P</sub>		630		nm	I <sub>F</sub> =20mA
Spectral Line Half-Width	Δλ		40		nm	I <sub>F</sub> =20mA
Dominant Wavelength	λ <sub>d</sub>		621		nm	I <sub>F</sub> =20mA
Forward Voltage, and Segment	V <sub>F</sub>		2.0	2.6	V	I <sub>F</sub> =10mA
Reverse Current, and Segment	I <sub>R</sub>			100	μ A	V <sub>R</sub> =5V
Luminous Intensity Matching Ratio	I <sub>v</sub> -m			2:1		I <sub>F</sub> =10mA

Note: Luminous intensity is measured with a light sensor and filter combination that approximates the CIE (Commission Internationale De L'Eclairage) eye-response curve.

### Typical Electrical / Optical Characteristic Curves (25°C Ambient Temperature Unless Otherwise Noted)

DISPLAYS

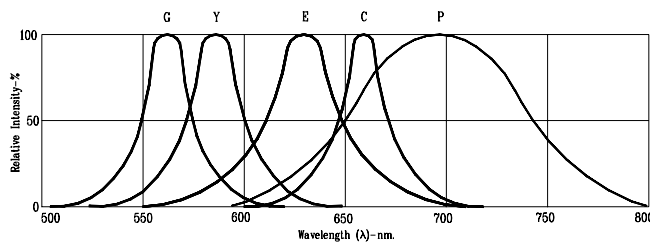

Fig1. RELATIVE INTENSITY VS. WAVELENGTH

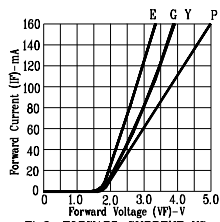

Fig2. FORWARD CURRENT VS. FORWARD VOLTAGE

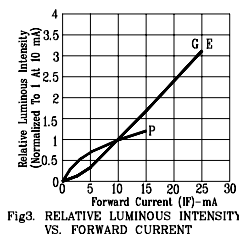

Fig3. RELATIVE LUMINOUS INTENSITY VS. FORWARD CURRENT

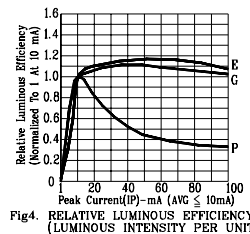

Fig4. RELATIVE LUMINOUS EFFICIENCY (LUMINOUS INTENSITY PER UNIT CURRENT) VS. PEAK CURRENT

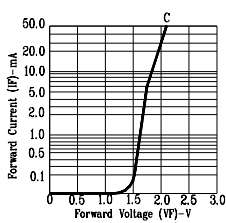

Fig5. FORWARD CURRENT VS. FORWARD VOLTAGE

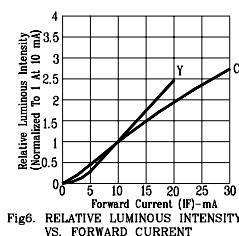

Fig6. RELATIVE LUMINOUS INTENSITY VS. FORWARD CURRENT

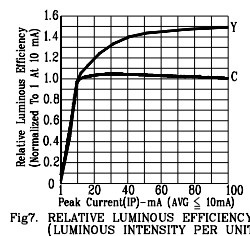

Fig7. RELATIVE LUMINOUS EFFICIENCY (LUMINOUS INTENSITY PER UNIT CURRENT) VS. PEAK CURRENT

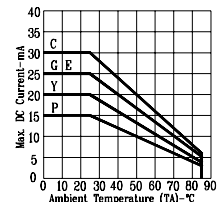

Fig8. MAX. ALLOWABLE DC CURRENT VS. AMBIENT TEMPERATURE.

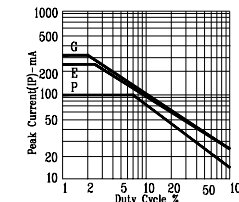

Fig9. MAX. PEAK CURRENT VS. DUTY CYCLE % (REFRESH RATE 1KHz)

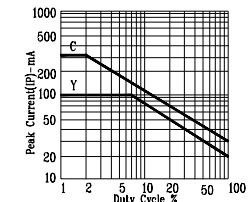

Fig10. MAX. PEAK CURRENT VS. DUTY CYCLE % (REFRESH RATE 1KHz)

NOTE: P=BRIGHT RED E=RED ORANGE G=GREEN Y=YELLOW C=AlGaAs RED (REFRESH RATE 1KHz)