

**FEATURES**

- \* 0.4 inch (10.0-mm) DIGIT HEIGHT.
- \* CONTINUOUS UNIFORM SEGMENTS.
- \* LOW POWER REQUIREMENTS.
- \* EXCELLENT CHARACTERS AND APPEARANCE.
- \* HIGH CONTRAST.
- \* HIGH BRIGHTNESS.
- \* WIDE VIEWING ANGLE.
- \* SOLID STATE RELIABILITY.
- \* COMMON ANODE OR COMMON CATHODE MODELS.
- \* CATEGORIZED FOR LUMINOUS INTENSITY.
- \* EASY MOUNTING ON P.C. BOARD.

**DESCRIPTION**

The LTP-4823E is a 0.4 inch (10 mm) digit height dual digit seven-segment display. This device utilizes red orange LED chips, which are made from GaAsP on a transparent GaP substrate, and has a gray face and white segments.

**DEVICE**

<b>PART NO.</b>	<b>DESCRIPTION</b>
RED ORANGE	DUPLEX COMMON ANODE
LTP-4823E	RT. HAND DECIMAL

**PACKAGE DIMENSIONS**

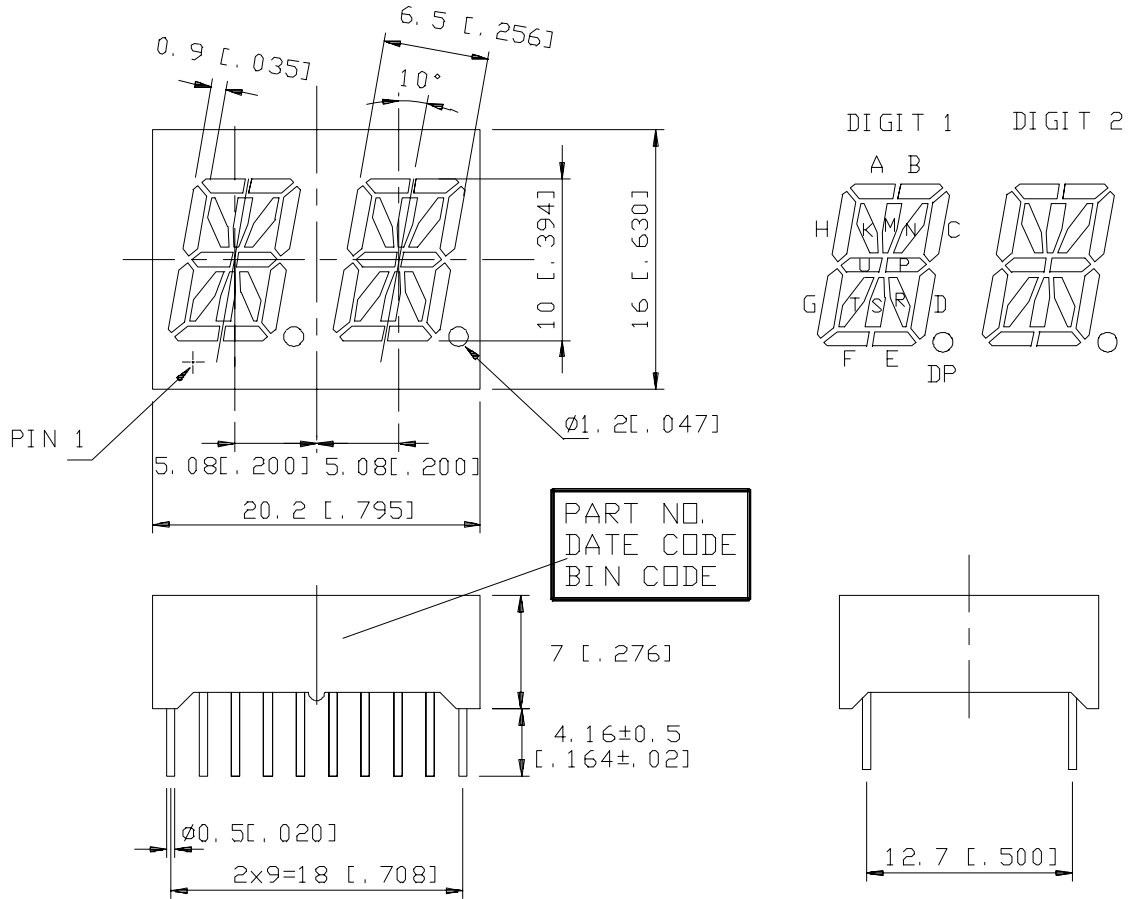

NOTES: All dimensions are in millimeters. Tolerance is  $\pm 0.25$  mm (0.01") unless otherwise noted.

**INTERNAL CIRCUIT DIAGRAM**

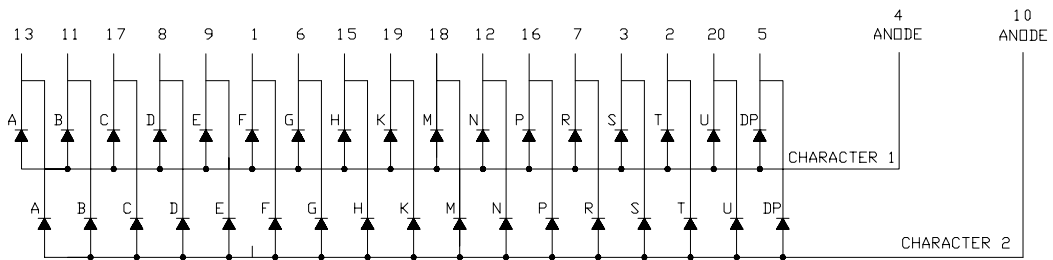

**PIN CONNECTION**

<b>No.</b>	<b>CONNECTION</b>
1	CATHODE F
2	CATHODE T
3	CATHODE S
4	COMMON ANODE CHARACTER 1
5	CATHODE DP
6	CATHODE G
7	CATHODE R
8	CATHODE D
9	CATHODE E
10	COMMON ANODE CHARACTER 2
11	CATHODE B
12	CATHODE N
13	CATHODE A
14	NO CONNECTION
15	CATHODE H
16	CATHODE P
17	CATHODE C
18	CATHODE M
19	CATHODE K
20	CATHODE U

**ABSOLUTE MAXIMUM RATING AT Ta=25°C**

PARAMETER	MAXIMUM RATING	UNIT
Average Power Dissipation Per Segment	75	mW
Peak Forward Current Per Segment	100	mA
Average Forward Current Per Segment	25	mA
Derating Linear From 25°C Per Segment	0.33	mA/°C
Reverse Voltage Per Segment	5	V
Operating Temperature Range	-35°C to +85°C	
Storage Temperature Range	-35°C to +85°C	
Solder Temperature: max 260°C for max 3sec at 1.6mm[1/16inch] below seating plane.		

**ELECTRICAL / OPTICAL CHARACTERISTICS AT Ta=25°C**

PARAMETER	SYMBOL	MIN.	TYP.	MAX.	UNIT	TEST CONDITION
Average Luminous Intensity	I <sub>v</sub>	800	2200		μcd	I <sub>p</sub> =10mA
Peak Emission Wavelength	λ <sub>p</sub>		630		nm	I <sub>F</sub> =20mA
Spectral Line Half-Width	Δλ		40		nm	I <sub>F</sub> =20mA
Dominant Wavelength	λ <sub>d</sub>		621		nm	I <sub>F</sub> =20mA
Forward Voltage Per Segment	V <sub>F</sub>		2.0	2.6	V	I <sub>F</sub> =20mA
Reverse Current Per Segment	I <sub>R</sub>			100	μA	V <sub>R</sub> =5V
Luminous Intensity Matching Ratio	I <sub>v</sub> -m			2:1		I <sub>F</sub> =10mA

Note: Luminous intensity is measured with a light sensor and filter combination that approximates the CIE (Commision Internationale De L'Eclairage) eye-response curve.

**TYPICAL ELECTRICAL / OPTICAL CHARACTERISTIC CURVES**

(25°C Ambient Temperature Unless Otherwise Noted)

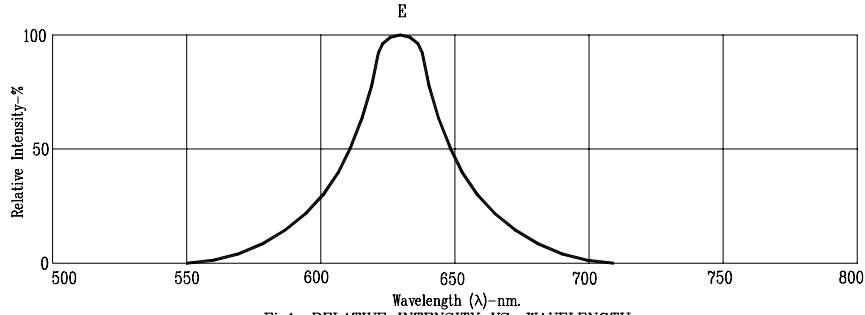

Fig1. RELATIVE INTENSITY VS. WAVELENGTH

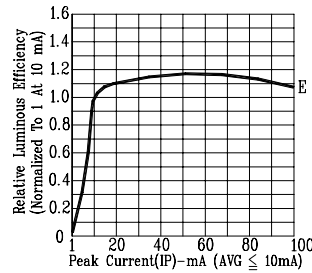

Fig2. RELATIVE LUMINOUS EFFICIENCY (LUMINOUS INTENSITY PER UNIT CURRENT) VS. PEAK CURRENT (REFRESH RATE 1KHz)

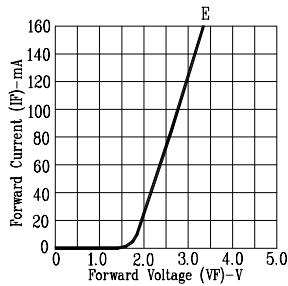

Fig3. FORWARD CURRENT VS. FORWARD VOLTAGE

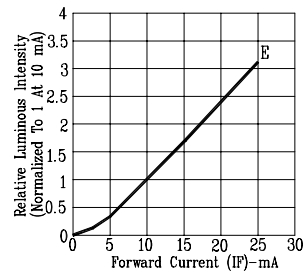

Fig4. RELATIVE LUMINOUS INTENSITY VS. FORWARD CURRENT

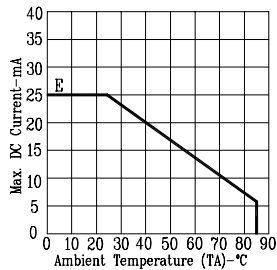

Fig5. MAX. ALLOWABLE DC CURRENT VS. AMBIENT TEMPERATURE.

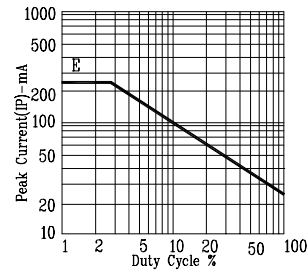

Fig6. MAX. PEAK CURRENT VS. DUTY CYCLE % (REFRESH RATE 1KHz)

NOTE: E=RED ORANGE