

FEATURES

- * 0.3 inch (7.62 mm) DIGIT HEIGHT
- * CONTINUOUS UNIFORM SEGMENTS
- * LOW POWER REQUIREMENT
- * EXCELLENT CHARACTERS APPEARANCE
- * HIGH BRIGHTNESS & HIGH CONTRAST
- * WIDE VIEWING ANGLE
- * SOLID STATE RELIABILITY
- * CATEGORIZED FOR LUMINOUS INTENSITY

DESCRIPTION

The LTP-3362Y is a 0.3 inch (7.62 mm) digit height dual digit 17-segment alphanumeric display. This device uses Yellow LED chips (GaAsP epi on GaP substrate). The display has black face and white segments.

DEVICE

PART NO.	DESCRIPTION
Yellow	Multiplex Common Cathode Rt. Hand Decimal
LTP-3362Y	

PACKAGE DIMENSIONS

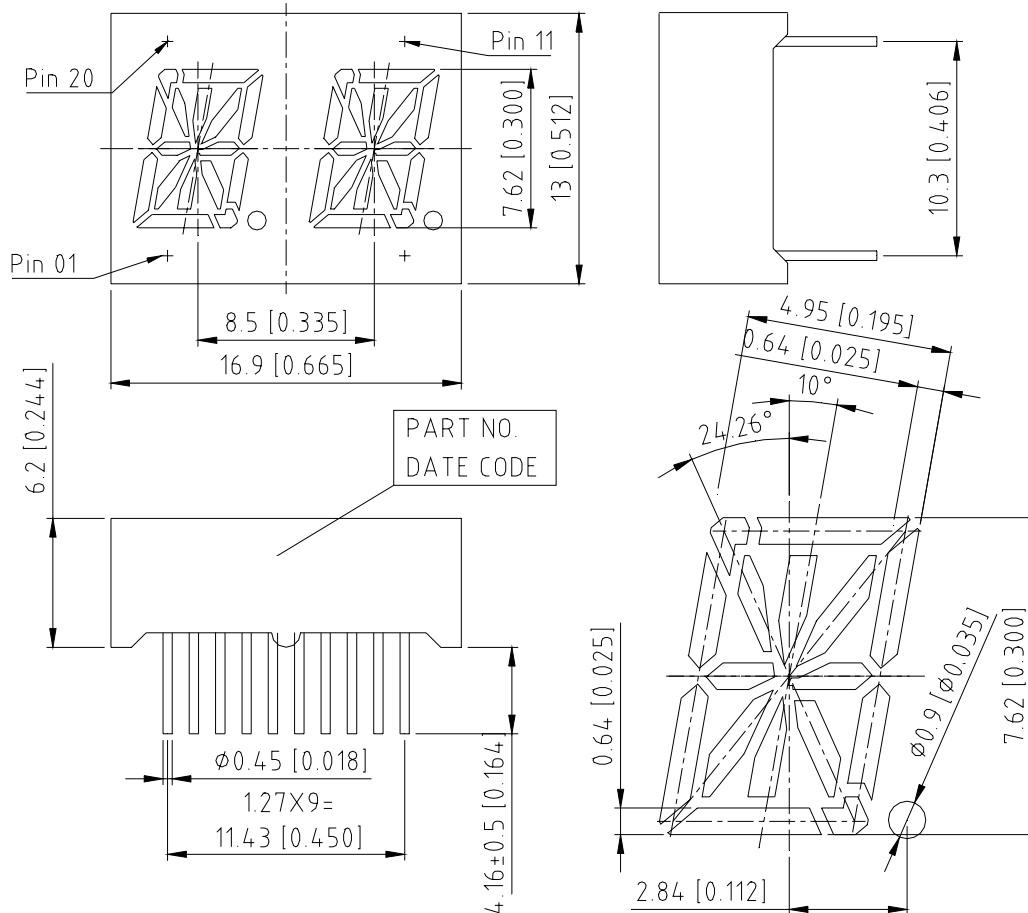

NOTES: All dimensions are in millimeters. Tolerances are $\pm 0.25\text{mm}$ (0.01") unless otherwise noted.

INTERNAL CIRCUIT DIAGRAM

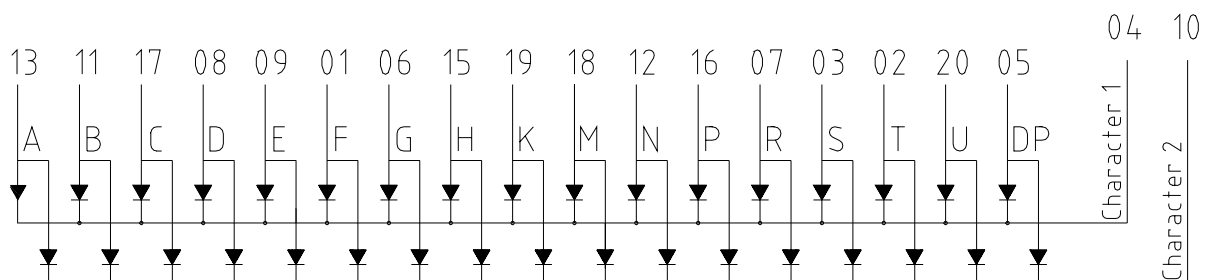

PIN CONNECTION

No.	CONNECTION
1	ANODE F
2	ANODE T
3	ANODE S
4	COMMON CATHODE (Digit 1)
5	ANODE DP
6	ANODE G
7	ANODE R
8	ANODE D
9	ANODE E
10	COMMON CATHODE (Digit 2)
11	ANODE B
12	ANODE N
13	ANODE A
14	NO CONNECTION
15	ANODE H
16	ANODE P
17	ANODE C
18	ANODE M
19	ANODE K
20	ANODE U

ABSOLUTE MAXIMUM RATING

PARAMETER	MAXIMUM RATING	UNIT
Power Dissipation Per Segment	60	mW
Peak Forward Current Per Segment (Frequency 1Khz, 10% duty cycle)	80*	mA
Continuous Forward Current Per Segment	25	mA
Forward Current Derating from 25 ⁰ C	0.33	mA/ ⁰ C
Reverse Voltage Per Segment	5	V
Operating Temperature Range	-35 ⁰ C to +85 ⁰ C	
Storage Temperature Range	-35 ⁰ C to +85 ⁰ C	
Soldering Conditions : 1/16 inch below seating plane for 3 seconds at 260 ⁰ C		

* see figure 5 to establish pulsed condition

ELECTRICAL / OPTICAL CHARACTERISTICS AT T_A=25⁰C

PARAMETER	SYMBOL	MIN.	TYP.	MAX.	UNIT	TEST CONDITION
Average Luminous Intensity Per Segment	I _v	800	2000		μcd	I _F =10mA
Peak Emission Wavelength	λ _p		585		nm	I _F =20mA
Spectral Line Half-Width	Δλ		35		nm	I _F =20mA
Dominant Wavelength	λ _d		588		nm	I _F =20mA
Forward Voltage Per Segment	V _F		2.0	2.6	V	I _F =20mA
Reverse Current Per Segment	I _R			100	μA	V _R =5V
Luminous Intensity Matching Ratio	I _v -m			2:1		I _F =10mA

Note: Luminous intensity is measured with a light sensor and filter combination that approximates the CIE (Commision Internationale De L'Eclairage) eye-response curve.

TYPICAL ELECTRICAL / OPTICAL CHARACTERISTIC CURVES

(25°C Ambient Temperature Unless Otherwise Noted)

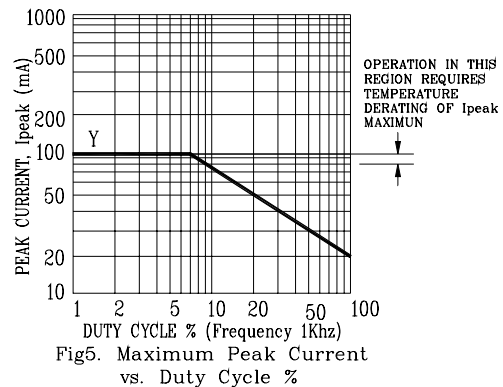
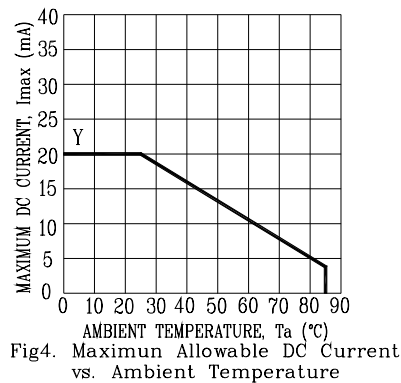
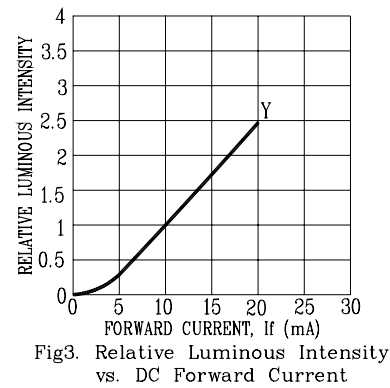
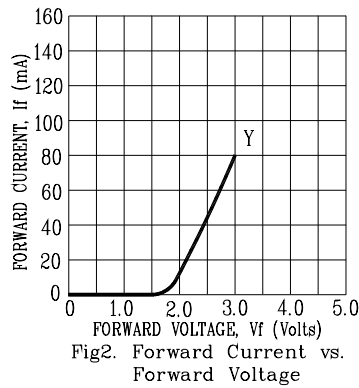
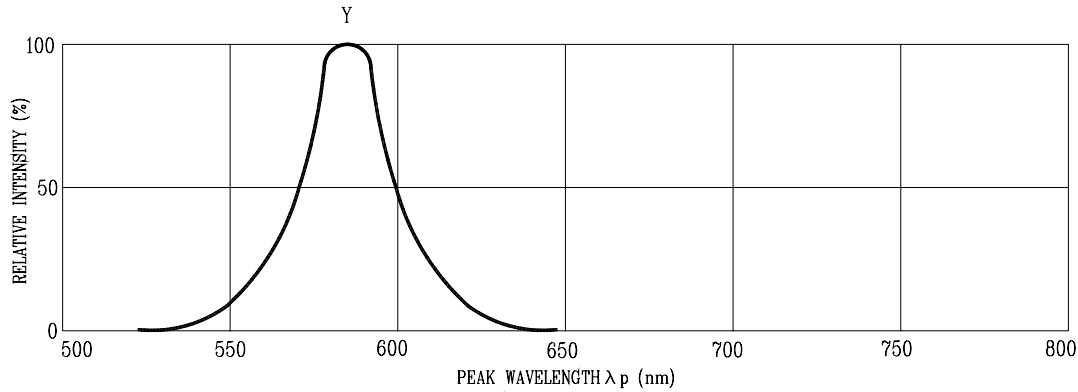

NOTE : Y= YELLOW