

FEATURES

- * 2.2 inch (57.22 mm) MATRIX HEIGHT.
- * LOW POWER REQUIREMENT.
- * SINGLE PLANE, WIDE VIEWING ANGLE.
- * SOLID STATE RELIABILITY.
- * 5 × 7 ARRAY WITH X-Y SELECT.
- * COMPATIBLE WITH USASCII AND EBCDIC CODES.
- * STACKABLE HORIZONTALLY.
- * CATEGORIZED FOR LUMINOUS INTENSITY.

DESCRIPTION

The LTP-22357C is a 2.2 inch (57.22 mm) matrix height 5× 7 dot matrix display. This device utilizes AlGaAs Red LED chips, which are made from GaAsP on a non-transparent GaAs substrate, and has a gray face and white dots.

DEVICE

PART NO.	DESCRIPTION
AlGaAs Red	ANODE ROW
LTP-22357C	CATHODE COLUMN

PACKAGE DIMENSIONS

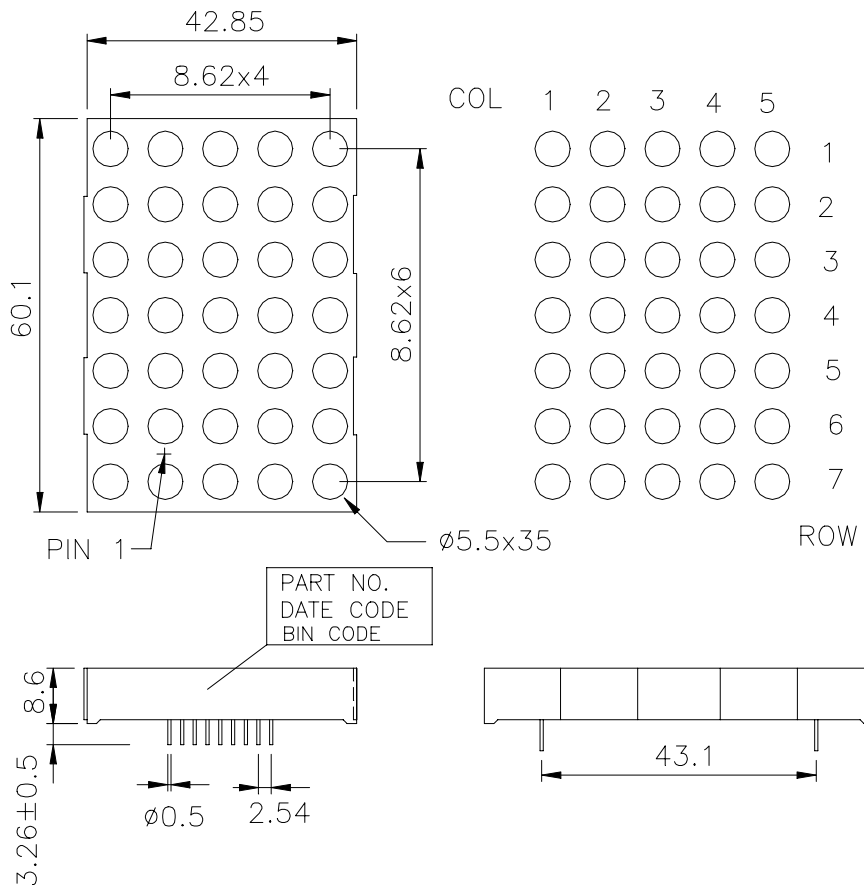

NOTES: All dimensions are in millimeters. Tolerances are ± 0.25 mm unless otherwise noted.

INTERNAL CIRCUIT DIAGRAM

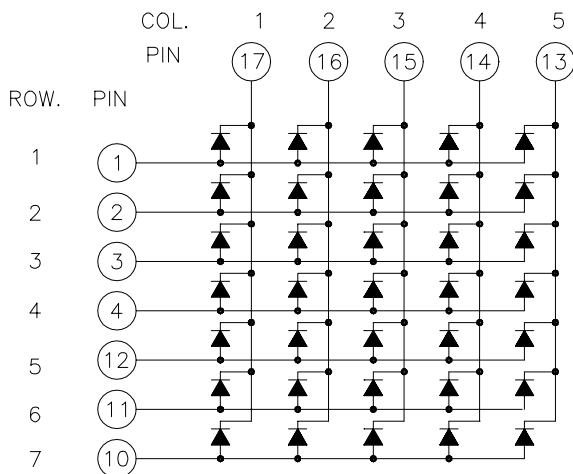

PIN CONNECTION

No.	CONNECTION	No.	CONNECTION
1	ANODE ROW 1	10	ANODE ROW 7
2	ANODE ROW 2	11	ANODE ROW 6
3	ANODE ROW 3	12	ANODE ROW 5
4	ANODE ROW 4	13	CATHODE CLOUMN 5
5	NO CONNECTION	14	CATHODE CLOUMN 4
6	NO CONNECTION	15	CATHODE CLOUMN 3
7	NO CONNECTION	16	CATHODE CLOUMN 2
8	NO CONNECTION	17	CATHODE CLOUMN 1
9	NO CONNECTION	18	NO CONNECTION

ABSOLUTE MAXIMUM RATING AT Ta=25°C

PARAMETER	MAXIMUM RATING	UNIT
Average Power Dissipation Per Dot	36	mW
Peak Forward Current Per Dot	125	mA
Average Forward Current Per Dot	15	mA
Derating Linear From 25°C Per Dot	0.20	mA/°C
Reverse Voltage Per Segment	5	V
Operating Temperature Range	-35°C to +85°C	
Storage Temperature Range	-35°C to +85°C	
Solder Temperature: max 260°C for max 3sec at 1.6mm[1/16inch] below seating plane.		

ELECTRICAL / OPTICAL CHARACTERISTICS AT Ta=25°C

PARAMETER	SYMBOL	MIN.	TYP.	MAX.	UNIT	TEST CONDITION
Average Luminous Intensity	I _v	6300	12000		μcd	I _p =80mA 1/16Duty
Peak Emission Wavelength	λ _p		660		nm	I _F =20mA
Spectral Line Half-Width	Δλ		35		nm	I _F =20mA
Dominant Wavelength	λ _d		638		nm	I _F =20mA
Forward Voltage any Dot	V _F		1.8	2.4	V	I _F =20mA
			2.0	2.7		I _F =80mA
Reverse Current any Dot	I _R			100	μA	V _R =5V
Luminous Intensity Matching Ratio	I _v -m			2:1		I _F =10mA

Note: Luminous intensity is measured with a light sensor and filter combination that approximates the CIE (Commision Internationale De L'Eclairage) eye-response curve.

TYPICAL ELECTRICAL / OPTICAL CHARACTERISTIC CURVES

(25°C Ambient Temperature Unless Otherwise Noted)

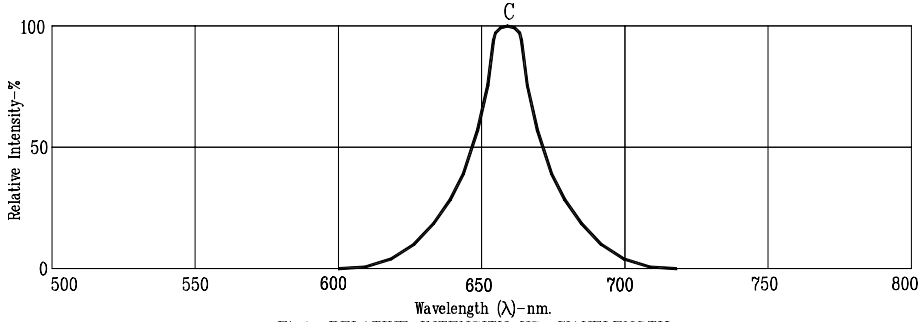

Fig1. RELATIVE INTENSITY VS. WAVELENGTH

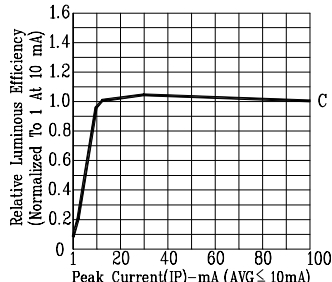

Fig2. RELATIVE LUMINOUS EFFICIENCY (LUMINOUS INTENSITY PER UNIT CURRENT) VS. PEAK CURRENT (REFRESH RATE 1KHz)

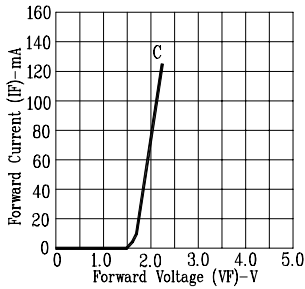

Fig3. FORWARD CURRENT VS. FORWARD VOLTAGE

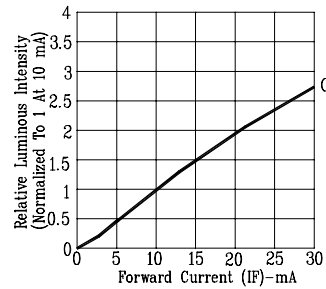

Fig4. RELATIVE LUMINOUS INTENSITY VS. FORWARD CURRENT

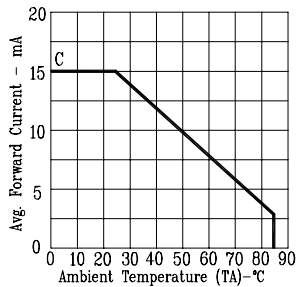

Fig5. MAX AVERAGE FORWARD CURRENT VS. AMBIENT TEMPERATURE.

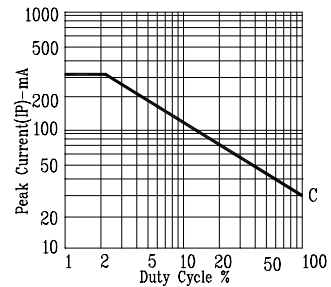

Fig6. MAX PEAK CURRENT VS. DUTY CYCLE % (REFRESH RATE 1KHz)

NOTE : C=AlGaAs RED