



# IR Emitter and Detector Product Data Sheet

LTE-7477LM1-TA

Spec No.: DS50-2001-010

Effective Date: 10/19/2001

Revision: -

**LITE-ON DCC**

**RELEASE**

BNS-OD-FC001/A4

## FEATURES

- \* HIGH SPEED
- \* HIGH POWER
- \* AVAILABLE FOR PULSE OPERATING
- \* BLUE TRANSPARENT COLOR PACKAGE

## PACKAGE DIMENSIONS

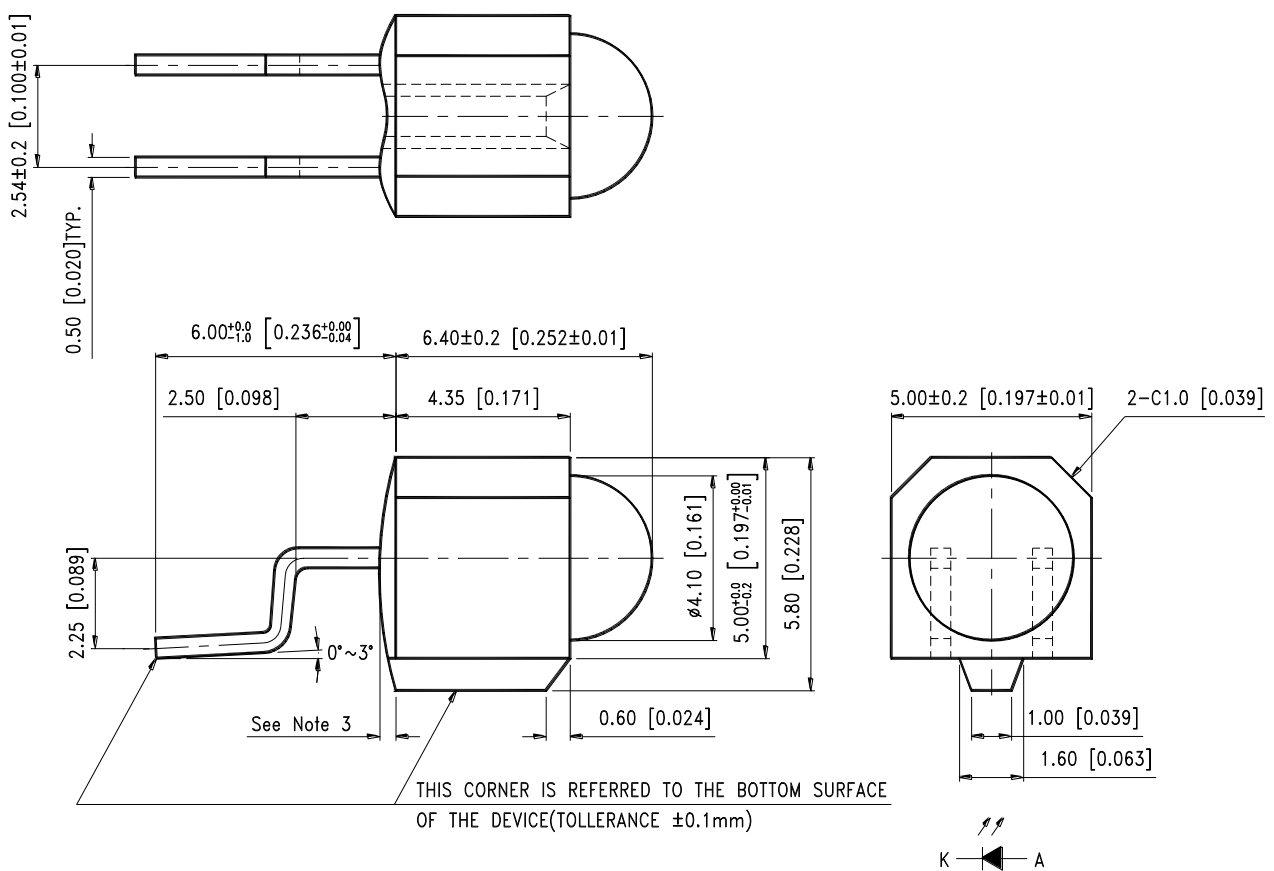

## NOTES:

1. All dimensions are in millimeters (inches).
2. Tolerance is  $\pm 0.25$ mm (.010") unless otherwise noted.
3. Protruded resin under flange is 1.5mm (.059") max.
4. Lead spacing is measured where the leads emerge from the package.
5. Specifications are subject to change without notice.

**ABSOLUTE MAXIMUM RATINGS AT TA=25°C**

PARAMETER	MAXIMUM RATING	UNIT
Power Dissipation	200	mW
Peak Forward Current (100pps, 10 $\mu$ s pulse)	2	A
Continuous Forward Current	100	mA
Reverse Voltage	5	V
Operating Temperature Range	-40°C to + 85°C	
Storage Temperature Range	-55°C to + 100°C	
Lead Soldering Temperature [1.6mm(.063") From Body]	260°C for 5 Seconds	

**ELECTRICAL / OPTICAL CHARACTERISTICS AT TA=25°C**

PARAMETER	SYMBOL	MIN.	TYP.	MAX.	UNIT	TEST CONDITION
Radiant Intensity	$I_E$	35		75	mW/sr	$I_F = 50mA$
Peak Emission Wavelength	$\lambda_P$		880		nm	$I_F = 50mA$
Spectral Line Half-Width	$\Delta \lambda$		50		nm	$I_F = 50mA$
Forward Voltage	$V_F$	1.5	1.75	2.1	V	$I_F = 350mA$ 100pps 10 $\mu$ s pulse
Reverse Current	$I_R$			100	$\mu A$	$V_R = 5V$
Rise/Fall Time	$T_r/T_f$		40		nS	10% ~ 90%
Viewing Angle (See FIG.6)	$2\theta_{1/2}$		16		deg.	$I_F = 20mA$

## TYPICAL ELECTRICAL / OPTICAL CHARACTERISTICS CURVES

(25°C Ambient Temperature Unless Otherwise Noted)

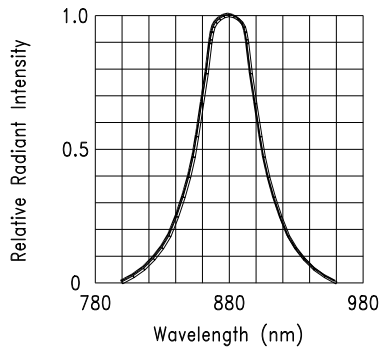

FIG.1 SPECTRAL DISTRIBUTION

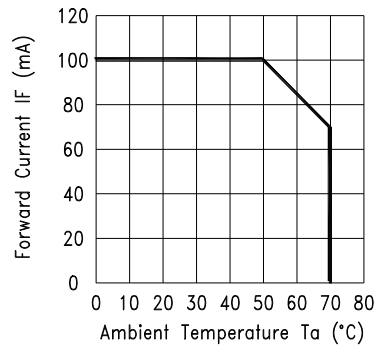

FIG.2 FORWARD CURRENT VS. AMBIENT TEMPERATURE

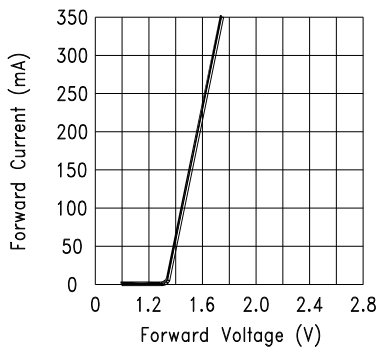

FIG.3 FORWARD CURRENT VS. FORWARD VOLTAGE

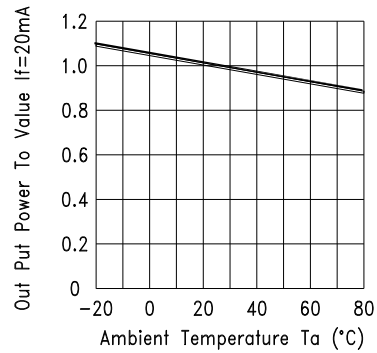

FIG.4 RELATIVE RADIANT INTENSITY VS. AMBIENT TEMPERATURE

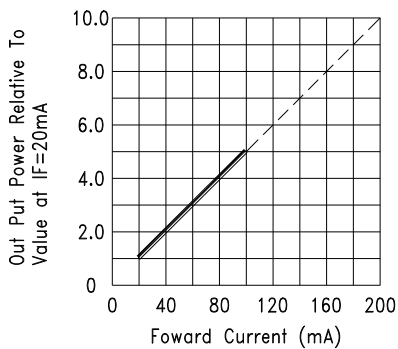

FIG.5 RELATIVE RADIANT INTENSITY VS. FORWARD CURRENT

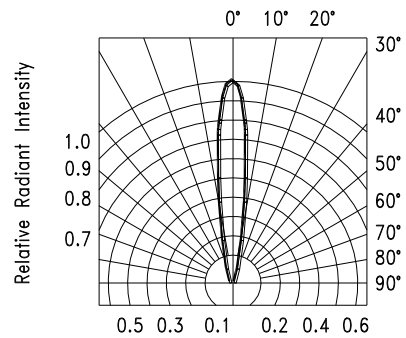
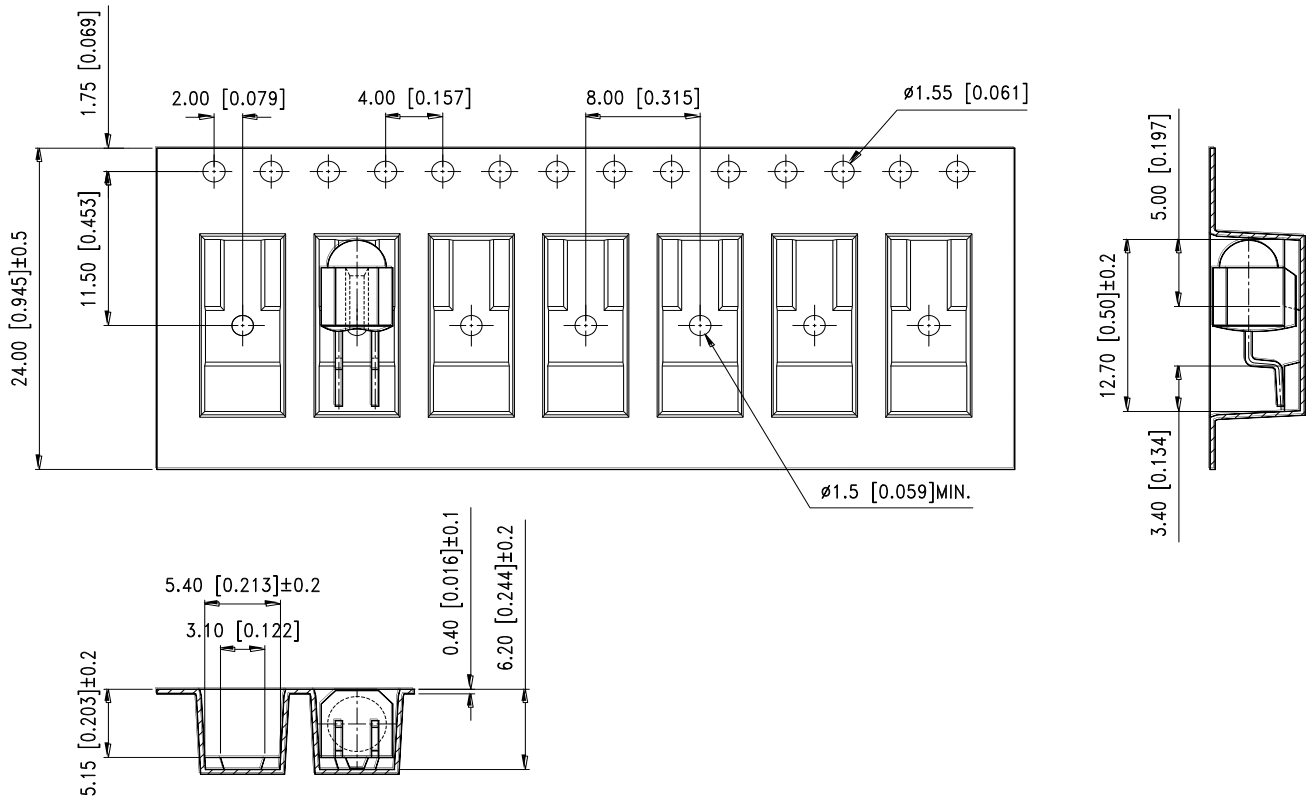

FIG.6 RADIATION DIAGRAM

## Packing



## Package Dimensions of Reel

