

Part Number: WP7113BR6.35/YD

YELLOW

### Features

- LED FIRMLY HELD BY SPACER-NO ADDITIONAL FIXTURING OR GLUEING NECESSARY.
- SUITABLE FOR BACK PANEL ILLUMINATION, CIRCUIT BOARD INDICATOR, LED INDICATOR.
- UL RATING:94V-0.
- HOUSING MATERIAL:TYPE 66 NYLON.
- RoHS COMPLIANT.

### Description

The Yellow source color devices are made with Gallium Arsenide Phosphide on Gallium Phosphide Yellow Light Emitting Diode.

### Package Dimensions

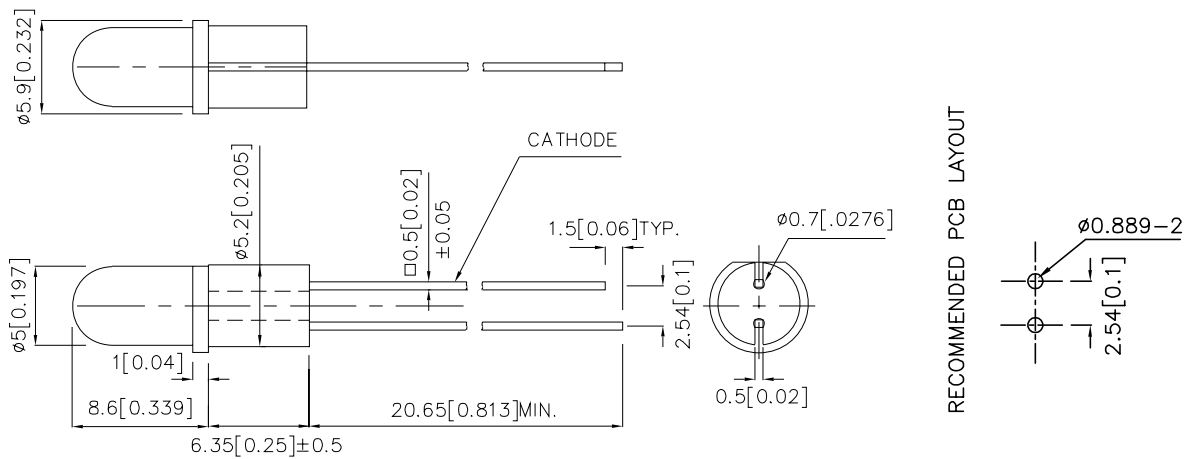

**Notes:**

1. All dimensions are in millimeters (inches).
2. Tolerance is  $\pm 0.25 (0.01")$  unless otherwise noted.
3. Lead spacing is measured where the leads emerge from the package.
4. Specifications are subject to change without notice.



## Selection Guide

Part No.	Dice	Lens Type	Iv (mcd) [2] @ 10mA		Viewing Angle [1]
			Min.	Typ.	2 $\theta$ 1/2
WP7113BR6.35/YD	YELLOW (GaAsP/GaP)	YELLOW DIFFUSED	5	20	30°

Notes:

1.  $\theta$ 1/2 is the angle from optical centerline where the luminous intensity is 1/2 the optical centerline value.
2. Luminous intensity/ luminous Flux: +/-15%.

## Electrical / Optical Characteristics at TA=25°C

Symbol	Parameter	Device	Typ.	Max.	Units	Test Conditions
$\lambda_{peak}$	Peak Wavelength	Yellow	590		nm	IF=20mA
$\lambda_D$ [1]	Dominant Wavelength	Yellow	588		nm	IF=20mA
$\Delta\lambda_{1/2}$	Spectral Line Half-width	Yellow	35		nm	IF=20mA
C	Capacitance	Yellow	20		pF	VF=0V;f=1MHz
VF [2]	Forward Voltage	Yellow	2.1	2.5	V	IF=20mA
IR	Reverse Current	Yellow		10	uA	VR= 5V

Notes:

1. Wavelength: +/-1nm.
2. Forward Voltage: +/-0.1V.

## Absolute Maximum Ratings at TA=25°C

Parameter	Yellow	Units
Power dissipation	75	mW
DC Forward Current	30	mA
Peak Forward Current [1]	140	mA
Reverse Voltage	5	V
Operating / Storage Temperature	-40°C To +85°C	
Lead Solder Temperature [2]	260°C For 3 Seconds	
Lead Solder Temperature [3]	260°C For 5 Seconds	

Notes:

1. 1/10 Duty Cycle, 0.1ms Pulse Width.
2. 2mm below package base.
3. 5mm below package base.

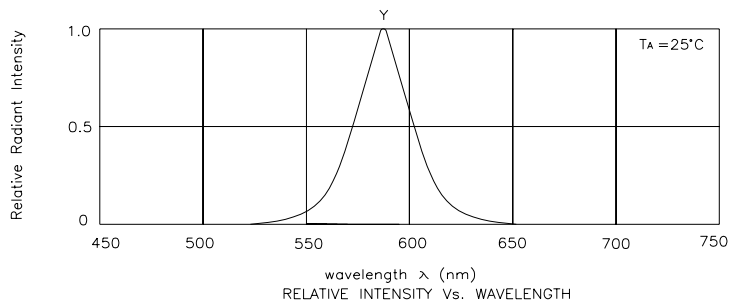

Yellow

WP7113BR6.35/YD

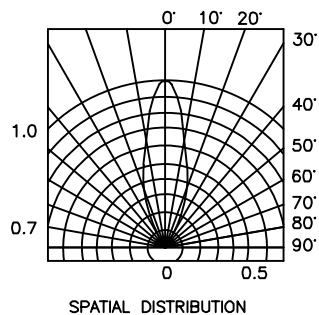
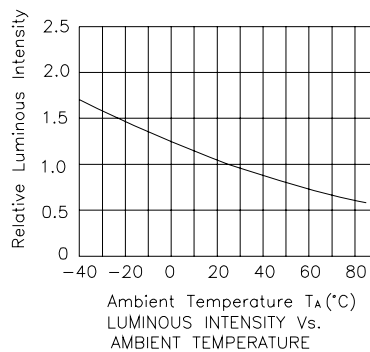
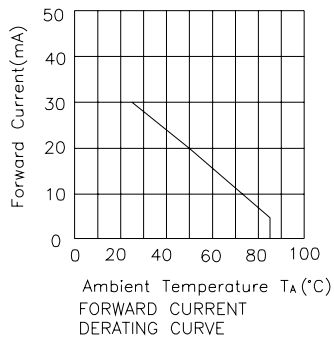
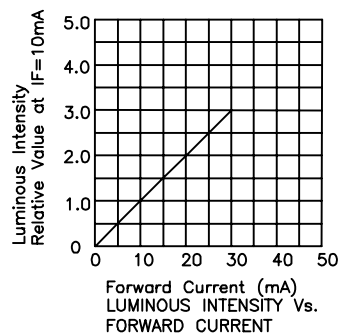
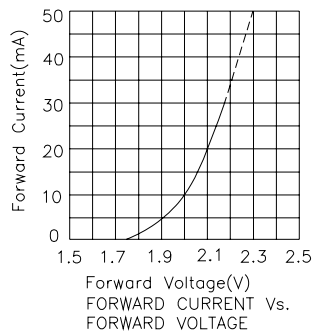

# Kingbright

## PACKING & LABEL SPECIFICATIONS

WP7113BR6.35/YD

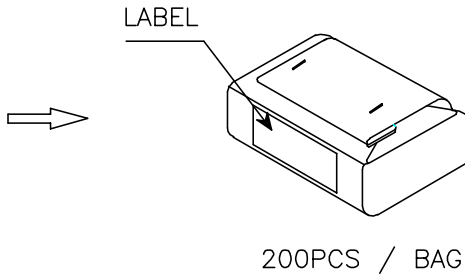
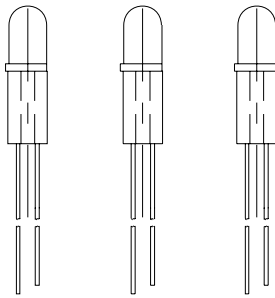

OUTSIDE LABEL

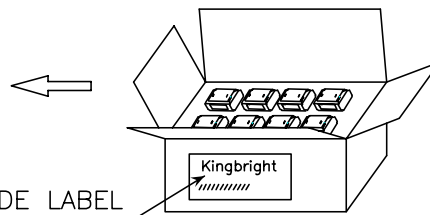

<h1>Kingbright</h1>				
Q.C.	<table border="1"> <tr> <td style="text-align: center;">QC</td> </tr> <tr> <td style="text-align: center;">xxx xx xxxx</td> </tr> <tr> <td style="text-align: center;">PASSED</td> </tr> </table>	QC	xxx xx xxxx	PASSED
QC				
xxx xx xxxx				
PASSED				
TYPE NO : WP7113BR6.35/YD				
QUANTITY : 200 pcs				
S/N : XXX	CODE: XX			
LOT NO : 				
MADE IN CHINA	RoHS Compliant			