

Part Number: TBC23-12EGWA

High Efficiency Red
Green

Features

- 2.3 INCH MATRIX HEIGHT.
- DOT SIZE 5mm.
- LOW CURRENT OPERATION.
- HIGH CONTRAST AND LIGHT OUTPUT.
- COMPATIBLE WITH ASCII AND EBCDIC CODES.
- STACKABLE HORIZONTALLY.
- EASY MOUNTING ON P.C. BOARDS OR SOCKETS.
- MULTICOLOR AVAILABLE.
- MECHANICALLY RUGGED.
- STANDARD : GRAY FACE, WHITE DOT.
- RoHS COMPLIANT.

Description

The High Efficiency Red source color devices are made with Gallium Arsenide Phosphide on Gallium Phosphide Orange Light Emitting Diode.

The Green source color devices are made with Gallium Phosphide Green Light Emitting Diode.

Package Dimensions & Internal Circuit Diagram

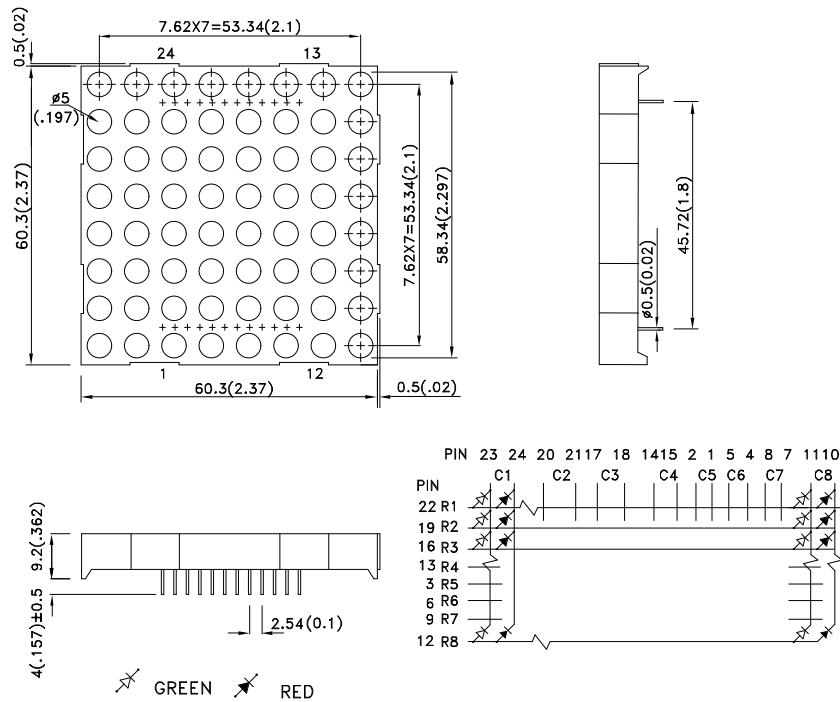

Notes:

1. All dimensions are in millimeters (inches), Tolerance is $\pm 0.25(0.01)$ unless otherwise noted.
2. Specifications are subject to change without notice.



Selection Guide

| Part No. | Dice | Lens Type | Iv (ucd) [1] @ 10mA | | Description |
|--------------|---------------------------------|----------------|------------------------|-------|----------------|
| | | | Min. | Typ. | |
| TBC23-12EGWA | High Efficiency Red (GaAsP/GaP) | WHITE DIFFUSED | 3000 | 14000 | Column Cathode |
| | Green (GaP) | | 4700 | 18500 | |

Note:

1. Luminous intensity/ luminous Flux: +/-15%.

Electrical / Optical Characteristics at TA=25°C

| Symbol | Parameter | Device | Typ. | Max. | Units | Test Conditions |
|-----------------------|--------------------------|------------------------------|------------|------------|-------|---------------------------|
| λ_{peak} | Peak Wavelength | High Efficiency Red Green | 627 565 | | nm | I _F =20mA |
| λ_D [1] | Dominant Wavelength | High Efficiency Red Green | 625 568 | | nm | I _F =20mA |
| $\Delta\lambda_{1/2}$ | Spectral Line Half-width | High Efficiency Red Green | 45 30 | | nm | I _F =20mA |
| C | Capacitance | High Efficiency Red Green | 15 15 | | pF | V _F =0V;f=1MHz |
| V _F [2] | Forward Voltage | High Efficiency Red Green | 2.0 2.2 | 2.5 2.5 | V | I _F =20mA |
| I _R | Reverse Current | High Efficiency Red Green | | 10 | uA | V _R =5V |

Notes:

1. Wavelength: +/-1nm.
2. Forward Voltage: +/-0.1V.

Absolute Maximum Ratings at TA=25°C

| Parameter | High Efficiency Red | Green | Units |
|-------------------------------|-----------------------|-------|-------|
| Power dissipation | 75 | 62.5 | mW |
| DC Forward Current | 30 | 25 | mA |
| Peak Forward Current [1] | 160 | 140 | mA |
| Reverse Voltage | 5 | | V |
| Operating/Storage Temperature | -40°C To +85°C | | |
| Lead Solder Temperature [2] | 260°C For 3-5 Seconds | | |

Notes:

1. 1/10 Duty Cycle, 0.1ms Pulse Width.
2. 2mm below package base.

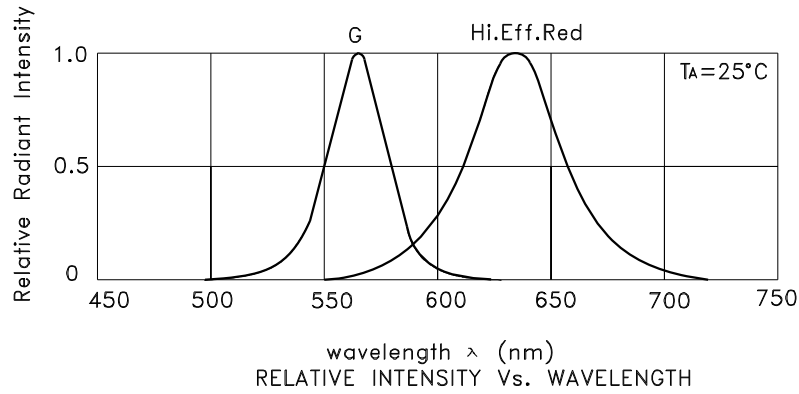

TBC23-12EGWA High Efficiency Red

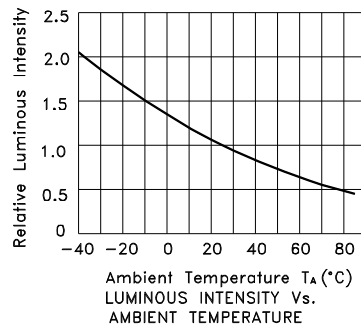
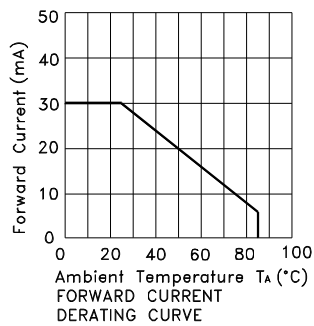
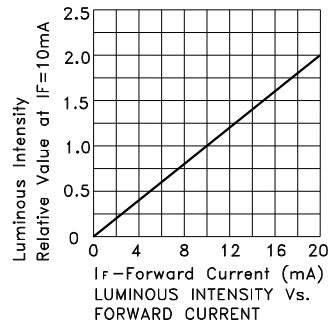
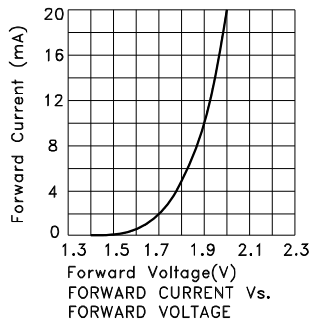

Green

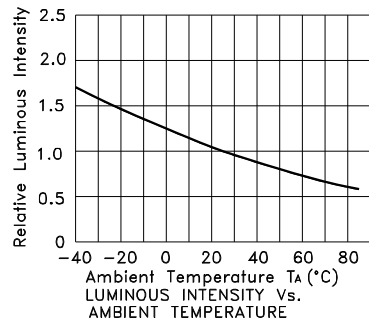
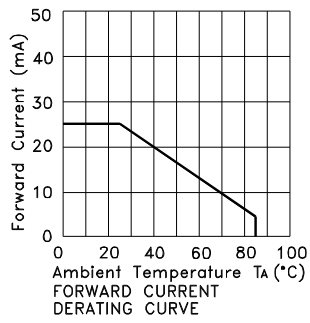
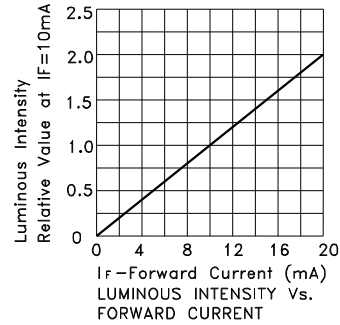
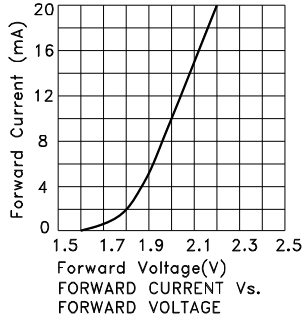

PACKING & LABEL SPECIFICATIONS

TBC23-12EGWA

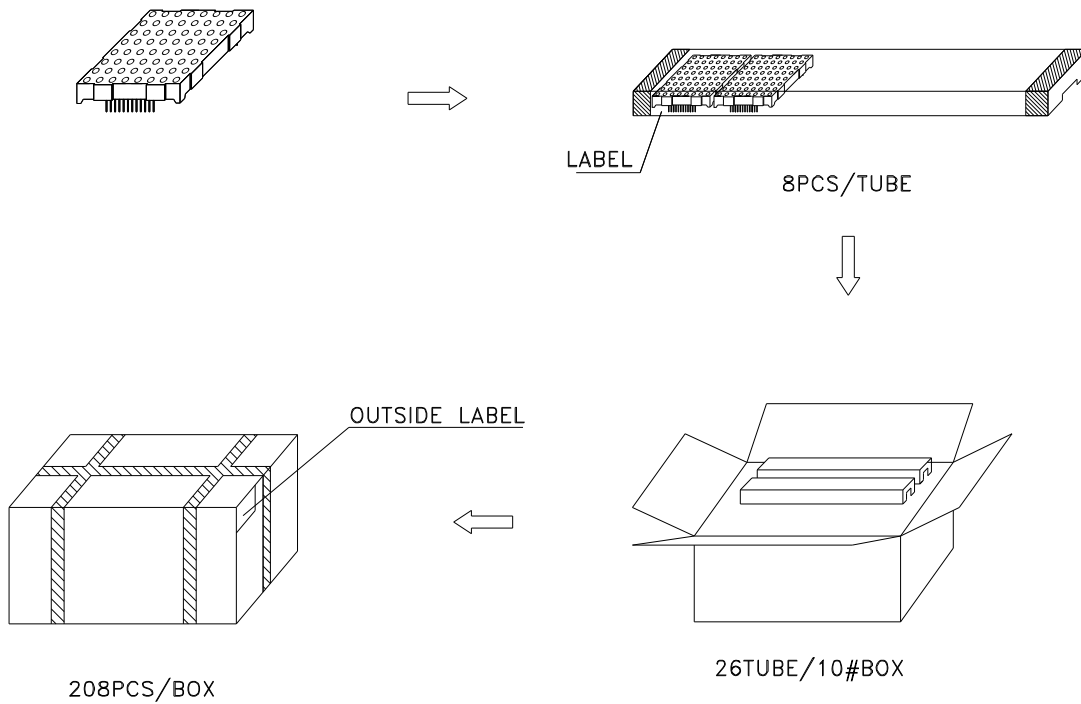

Inside LABEL Paste On The IC-tube

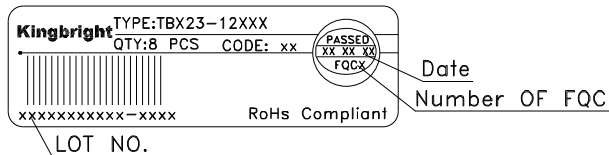

Outside LABEL Paste On The Box

