

Features

- 2.3 inch digit height.
- Low current operation.
- Excellent character appearance.
- High light output.
- Easy mounting on P.C. boards or sockets.
- Multicolor available.
- Mechanically rugged.
- Standard : gray face, white segment.
- RoHS compliant.

Description

The Hyper Red source color devices are made with AlGaInP on GaAs substrate Light Emitting Diode.

Package Dimensions& Internal Circuit Diagram

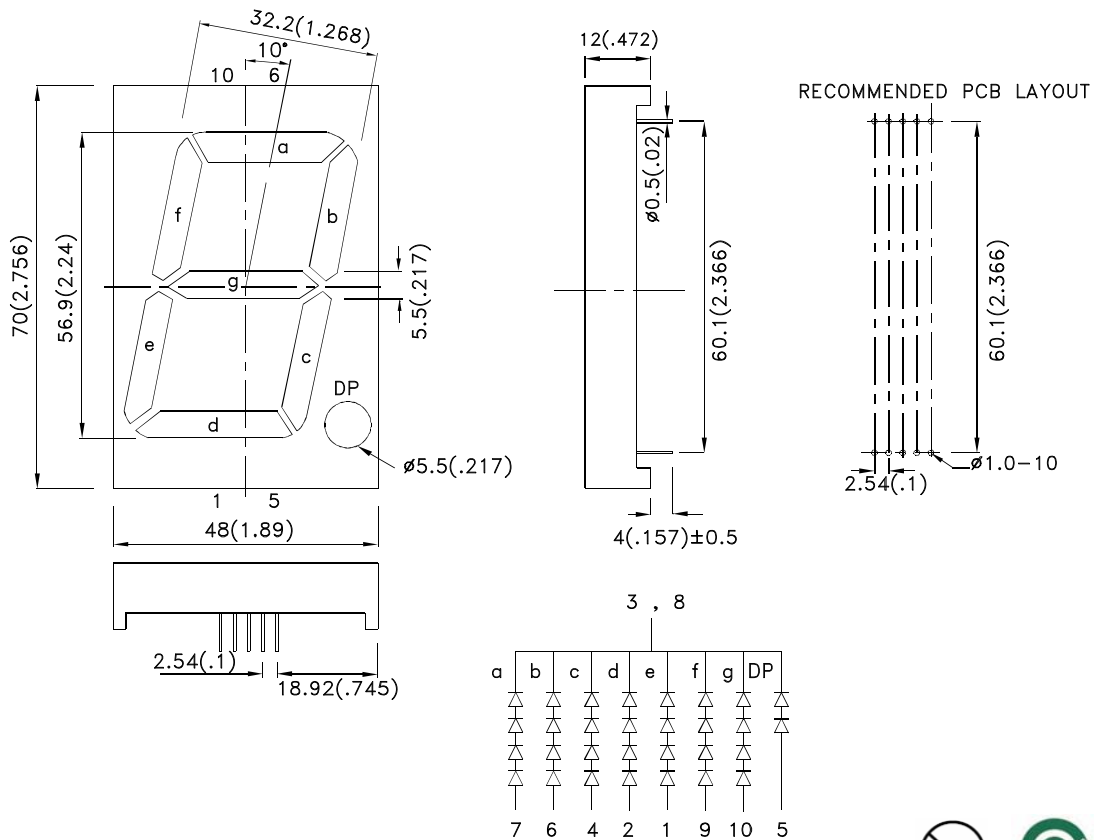

Notes:

1. All dimensions are in millimeters (inches), Tolerance is $\pm 0.25(0.01)$ unless otherwise noted.
2. The specifications, characteristics and technical data described in the datasheet are subject to change without prior notice.



Selection Guide

Part No.	Dice	Lens Type	Iv (ucd) [1] @ 10mA		Description
			Min.	Typ.	
SC23-12SURKWA	Hyper Red (AlGaInP)	White Diffused	88000	260000	Common Cathode, Rt. Hand Decimal

Note:

1. Luminous Intensity / Luminous Flux: +/-15%.

Electrical / Optical Characteristics at TA=25°C

Symbol	Parameter	Device	Typ.	Max.	Units	Test Conditions
λ_{peak}	Peak Wavelength	Hyper Red	650		nm	I _F =20mA
λ_D [1]	Dominant Wavelength	Hyper Red	630		nm	I _F =20mA
$\Delta\lambda_{1/2}$	Spectral Line Half-width	Hyper Red	28		nm	I _F =20mA
C	Capacitance	Hyper Red	35		pF	V _F =0V; f=1MHz
V _F [2]	Forward Voltage Per Segment Or (DP)	Hyper Red	7.8 (3.9)	10.0 (5.0)	V	I _F =20mA
I _R	Reverse Current Per Segment Or (DP)	Hyper Red		10 (10)	uA	V _R =5V (V _R =5V)

Notes:

1. Wavelength: +/-1nm.
2. Forward Voltage: +/-0.1V.

Absolute Maximum Ratings at TA=25°C

Parameter	Hyper Red	Units
Power dissipation Per Segment Or (DP)	300 (150)	mW
DC Forward Current Per Segment Or (DP)	30 (30)	mA
Peak Forward Current [1] Per Segment Or (DP)	185 (185)	mA
Reverse Voltage Per Segment Or (DP)	5 (5)	V
Operating / Storage Temperature	-40°C To +85°C	
Lead Solder Temperature[2]	260°C For 3-5 Seconds	

Notes:

1. 1/10 Duty Cycle, 0.1ms Pulse Width.
2. 2mm below package base.

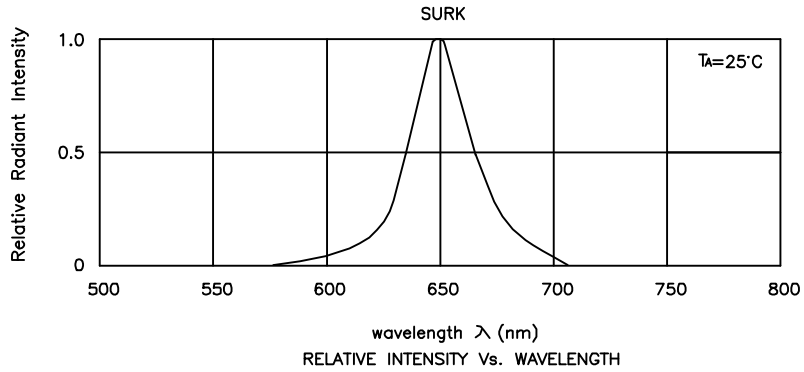

SC23-12SURKWA Hyper Red

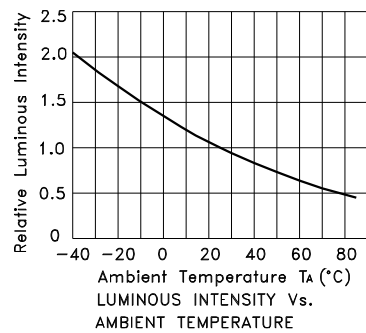
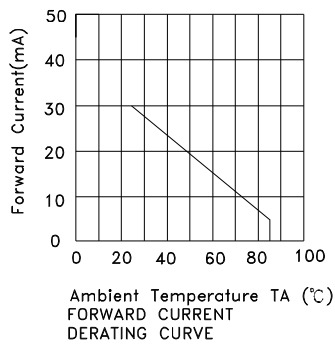
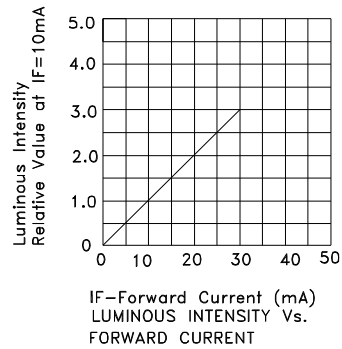
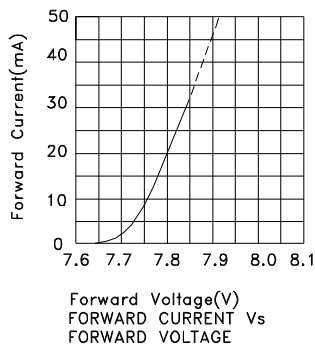

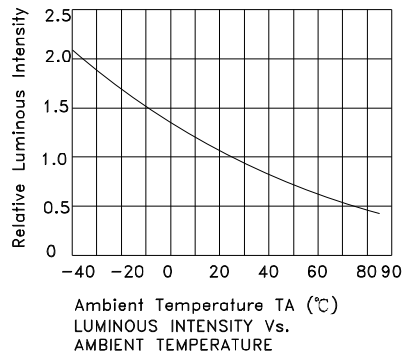
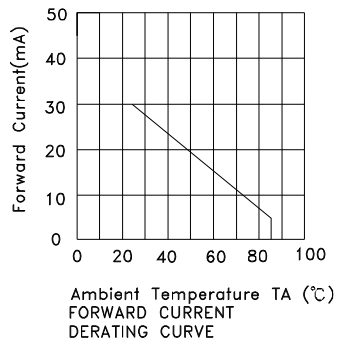
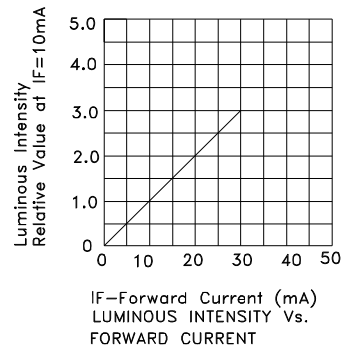
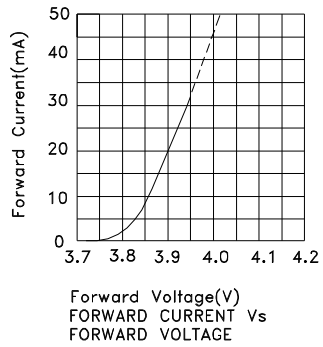

PACKING & LABEL SPECIFICATIONS

SC23-12SURKWA

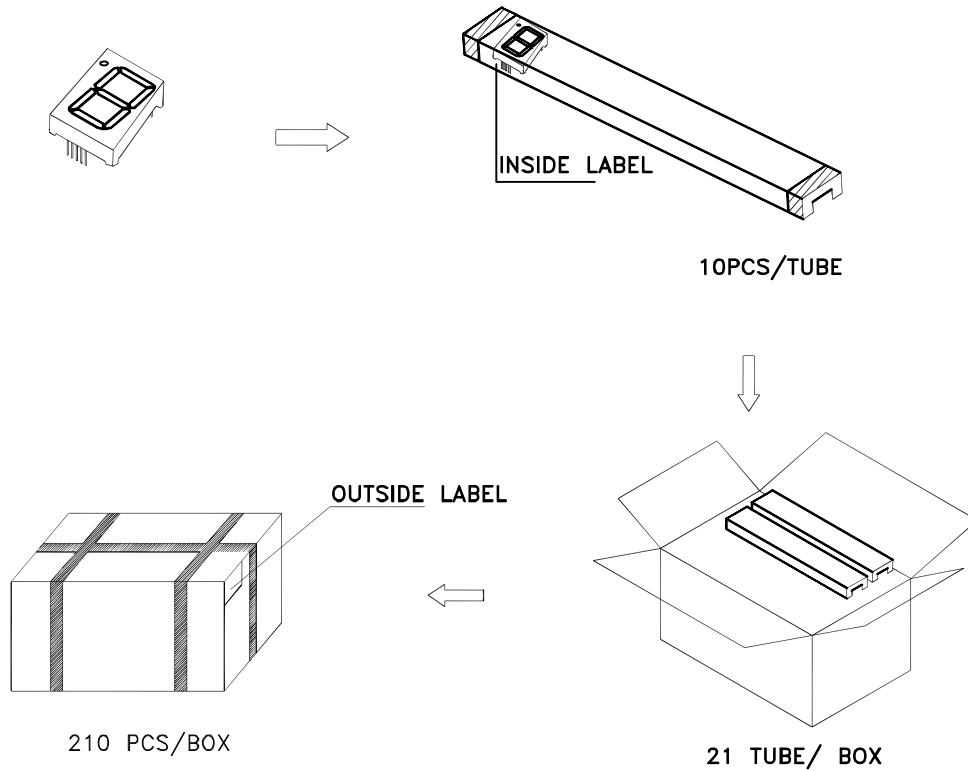

Inside Label On IC-tube

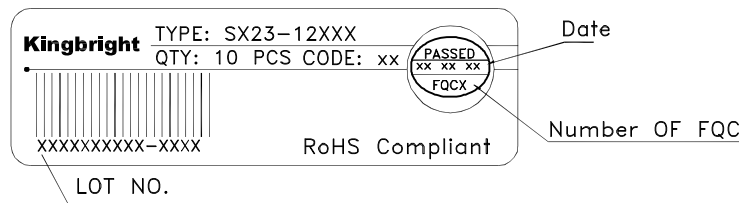

Outside Label On Box

