

Part Number: SC23-11SEKWA

Super Bright Orange

Features

- 2.3 inch digit height.
- Low current operation.
- Excellent character appearance.
- High light output.
- Easy mounting on P.C. boards or sockets.
- Multicolor available.
- Mechanically rugged.
- Standard : gray face, white segment.
- RoHS compliant.

Description

The Super Bright Orange device is made with AlGaInP (on GaAs substrate) light emitting diode chip.

Package Dimensions & Internal Circuit Diagram

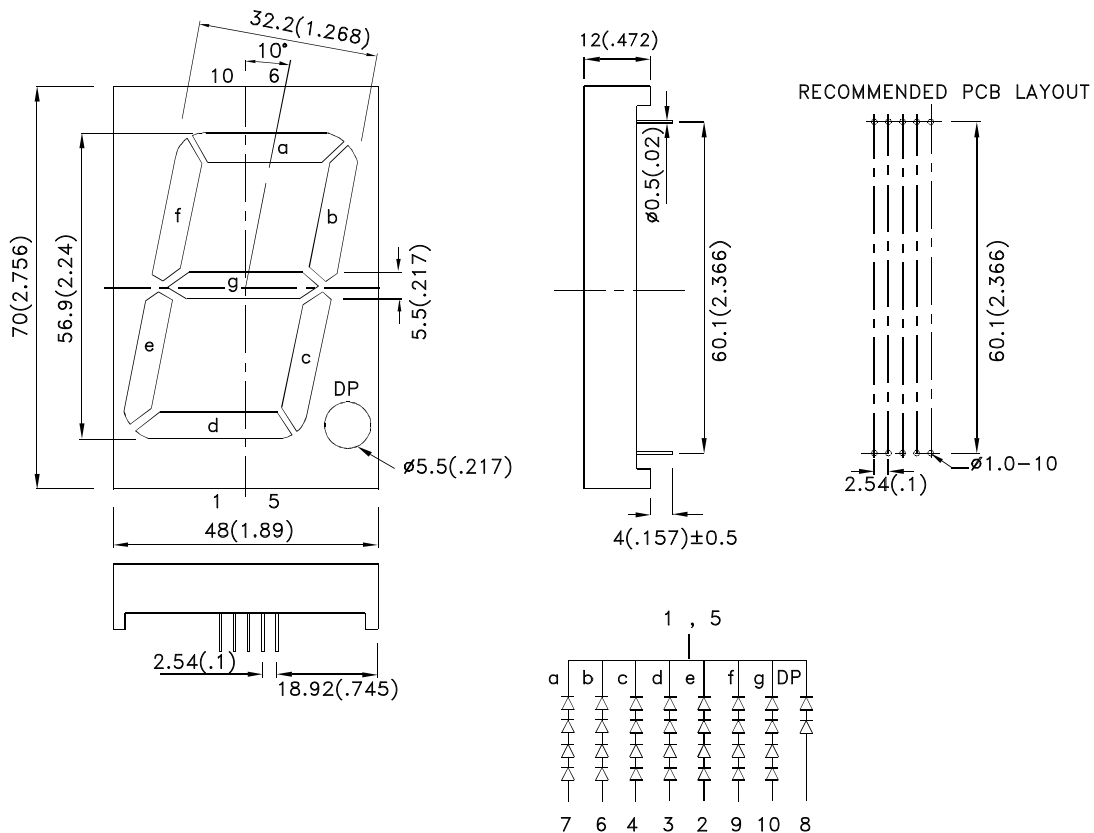

Notes:

1. All dimensions are in millimeters (inches), Tolerance is $\pm 0.25(0.01)$ unless otherwise noted.
2. The specifications, characteristics and technical data described in the datasheet are subject to change without prior notice.



Selection Guide

Part No.	Dice	Lens Type	Iv (ucd) [1] @ 10mA		Description
			Min.	Typ.	
SC23-11SEKWA	Super Bright Orange (AlGaInP)	White Diffused	88000	310000	Common Cathode, Rt. Hand Decimal

Note:

1. Luminous Intensity / Luminous Flux: +/-15%.

Electrical / Optical Characteristics at TA=25°C

Symbol	Parameter	Device	Typ.	Max.	Units	Test Conditions
λ_{peak}	Peak Wavelength	Super Bright Orange	610		nm	IF=20mA
λ_D [1]	Dominant Wavelength	Super Bright Orange	601		nm	IF=20mA
$\Delta\lambda_{1/2}$	Spectral Line Half-width	Super Bright Orange	29		nm	IF=20mA
C	Capacitance	Super Bright Orange	15		pF	VF=0V;f=1MHz
VF [2]	Forward Voltage Per Segment Or (DP)	Super Bright Orange	8.4 (4.2)	10 (5.0)	V	IF=20mA
IR	Reverse Current Per Segment Or (DP)	Super Bright Orange		10 (10)	uA	VR = 5V (VR = 5V)

Notes:

1. Wavelength: +/-1nm.

2. Forward Voltage: +/-0.1V.

Absolute Maximum Ratings at TA=25°C

Parameter	Super Bright Orange	Units
Power dissipation Per Segment Or (DP)	300(150)	mW
DC Forward Current Per Segment Or (DP)	30 (30)	mA
Peak Forward Current [1] Per Segment Or (DP)	195 (195)	mA
Reverse Voltage Per Segment Or (DP)	5 (5)	V
Operating/Storage Temperature	-40°C To +85°C	
Lead Solder Temperature [2]	260°C For 3~ 5 Seconds	

Notes:

1. 1/10 Duty Cycle, 0.1ms Pulse Width.

2. 2mm below package base.



Super Bright Orange

SC23-11SEKWA

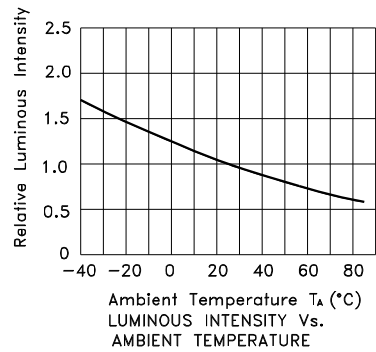
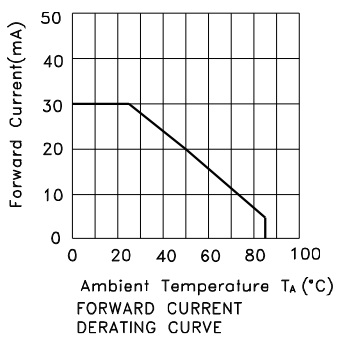
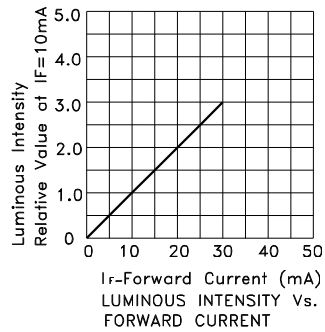
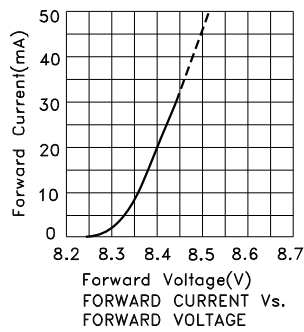

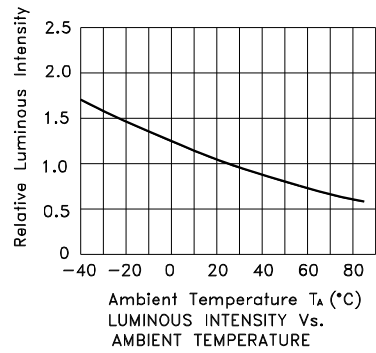
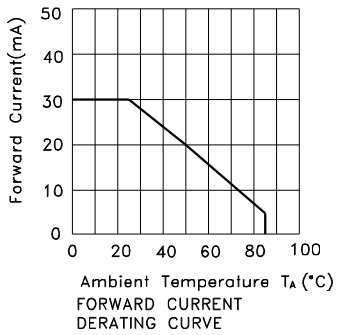
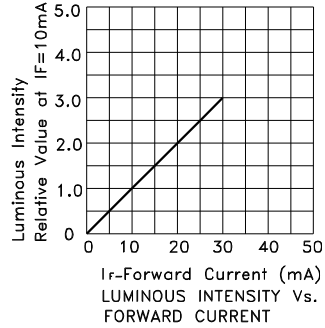
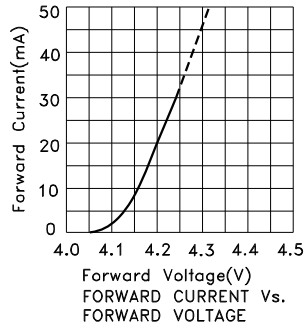

PACKING & LABEL SPECIFICATIONS

SC23-11SEKWA

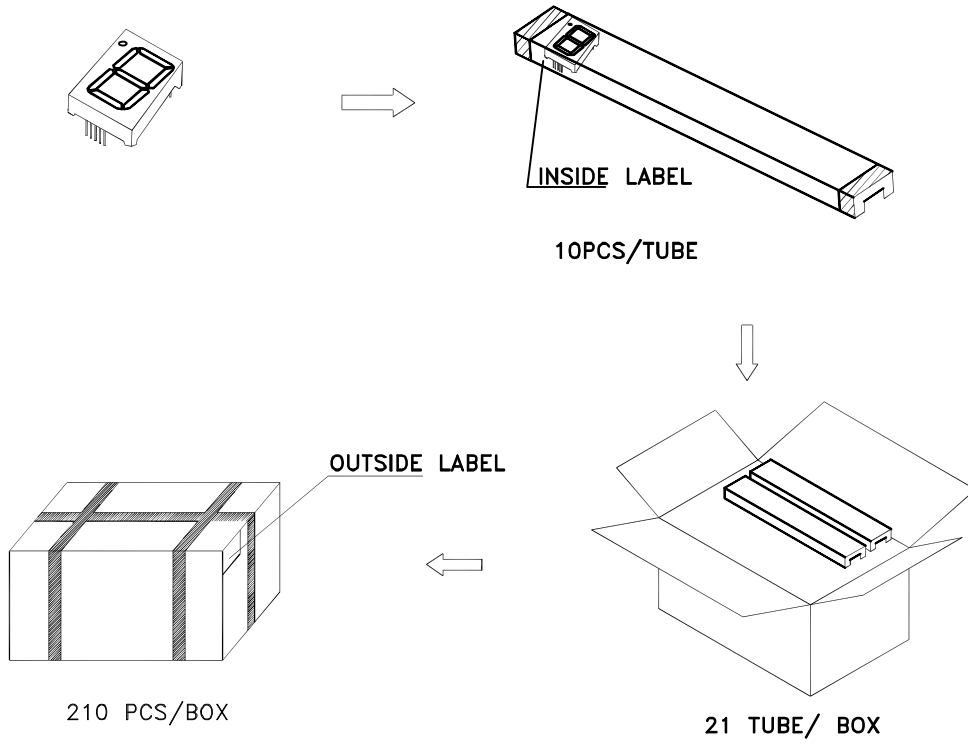

Inside Label on Ic-Tube

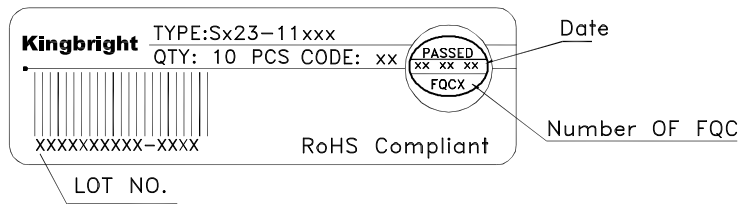

Outside Label on Box

