

Part Number: SBC23-11EGWA

High Efficiency Red
Green

Features

- 2.3 INCH DIGIT HEIGHT.
- LOW CURRENT OPERATION.
- EXCELLENT CHARACTER APPEARANCE.
- HIGH LIGHT OUTPUT.
- EASY MOUNTING ON P.C. BOARDS OR SOCKETS.
- MULTICOLOR AVAILABLE.
- MECHANICALLY RUGGED.
- STANDARD : GRAY FACE, WHITE SEGMENT.
- RoHS COMPLIANT.

Description

The High Efficiency Red source color devices are made with Gallium Arsenide Phosphide on Gallium Phosphide Orange Light Emitting Diode.

The Green source color devices are made with Gallium Phosphide Green Light Emitting Diode.

Package Dimensions & Internal Circuit Diagram

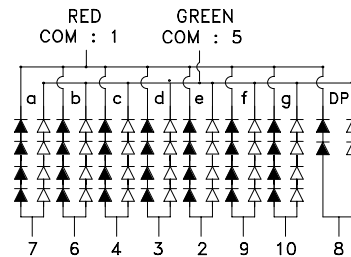
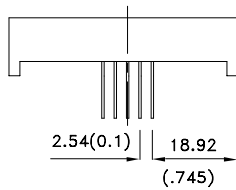
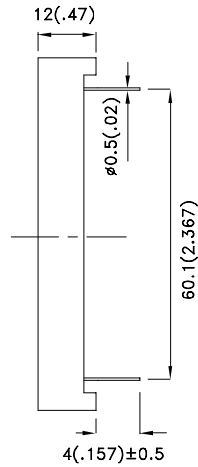
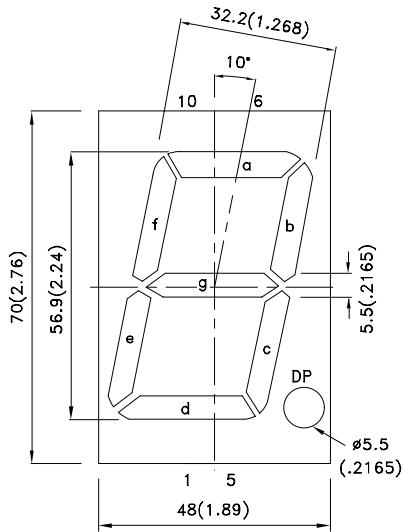

Notes:

1. All dimensions are in millimeters (inches), Tolerance is $\pm 0.25(0.01)$ unless otherwise noted.
2. Specifications are subject to change without notice.



Selection Guide

Part No.	Dice	Lens Type	Iv (ucd) [1] @ 10mA		Description
			Min.	Typ.	
SBC23-11EGWA	High Efficiency Red (GaAsP/GaP)	WHITE DIFFUSED	12000	55500	Common Cathode. Rt. Hand Decimal
	Green (GaP)		12000	53000	

Note:

1. Luminous intensity/ luminous Flux: +/-15%.

Electrical / Optical Characteristics at TA=25°C

Symbol	Parameter	Device	Typ.	Max.	Units	Test Conditions
λ_{peak}	Peak Wavelength	High Efficiency Red Green	627 565		nm	I _F =20mA
λ_D [1]	Dominant Wavelength	High Efficiency Red Green	625 568		nm	I _F =20mA
$\Delta\lambda_{1/2}$	Spectral Line Half-width	High Efficiency Red Green	45 30		nm	I _F =20mA
C	Capacitance	High Efficiency Red Green	15 15		pF	V _F =0V;f=1MHz
V _F [2]	Forward Voltage Per Segment Or (DP)	High Efficiency Red Green	8.0 (4.0) 8.8 (4.4)	10.0 (5.0) 10.0 (5.0)	V	I _F =20mA
I _R	Reverse Current Per Segment Or (DP)	High Efficiency Red Green		10 (10)	uA	V _R =20V (V _R =10V)

Notes:

1. Wavelength: +/-1nm.

2. Forward Voltage: +/-0.1V.

Absolute Maximum Ratings at TA=25°C

Parameter	High Efficiency Red	Green	Units
Power dissipation Per Segment Or (DP)	300 (150)	250 (125)	mW
DC Forward Current Per Segment Or (DP)	30 (30)	25 (25)	mA
Peak Forward Current [1] Per Segment Or (DP)	160 (160)	140 (140)	mA
Reverse Voltage Per Segment Or (DP)	20 (10)		V
Operating/Storage Temperature	-40°C To +85°C		
Lead Solder Temperature [2]	260°C For 3-5 Seconds		

Notes:

1. 1/10 Duty Cycle, 0.1ms Pulse Width.

2. 2mm below package base.

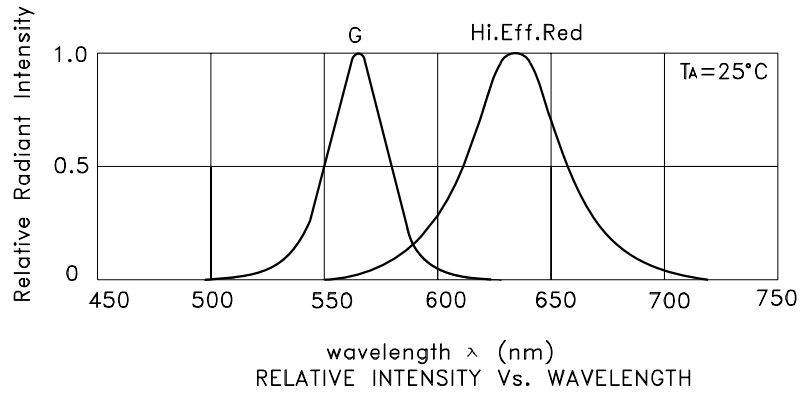

SBC23-11EGWA High Efficiency Red

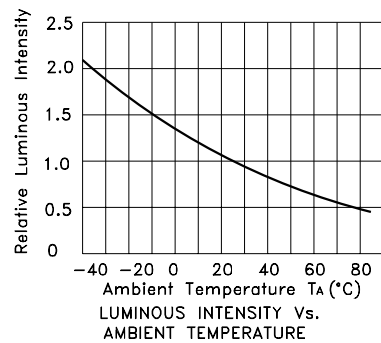
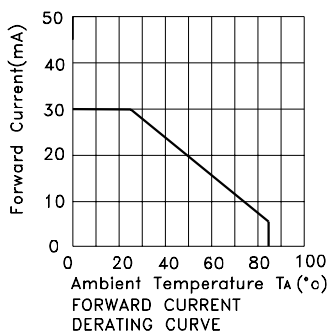
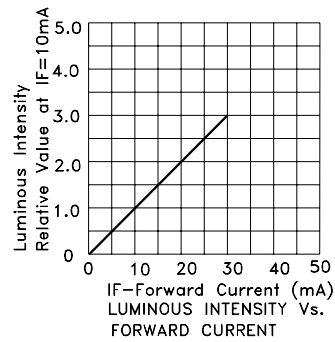
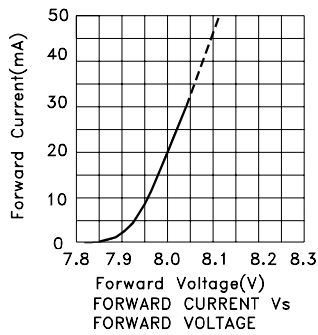

High Efficiency Red

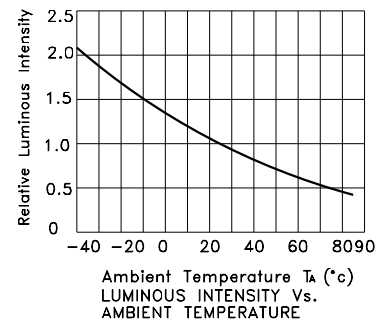
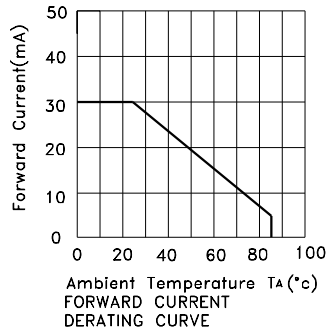
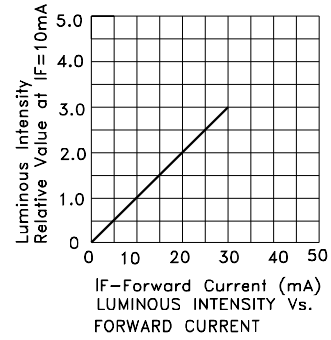
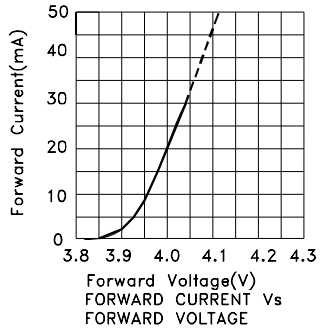

Green

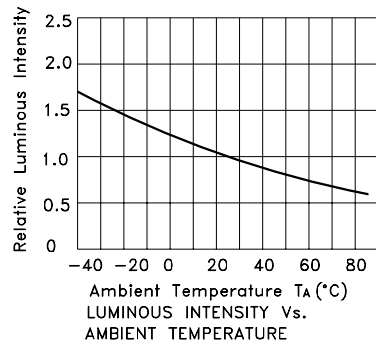
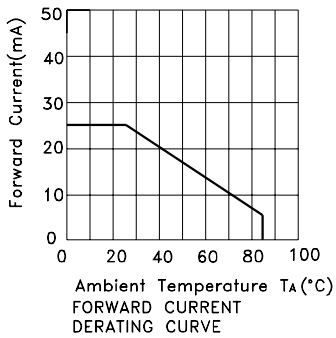
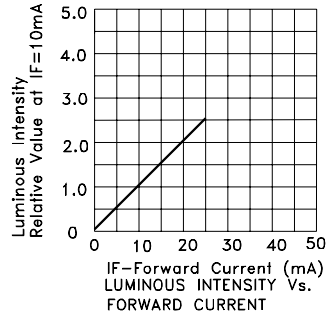
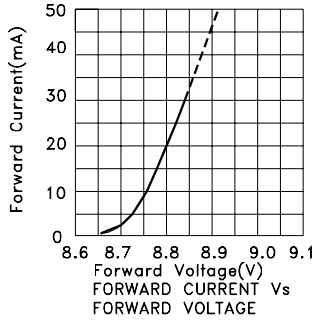

Green

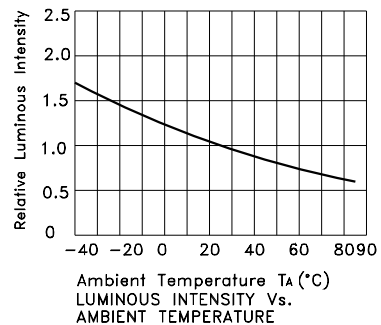
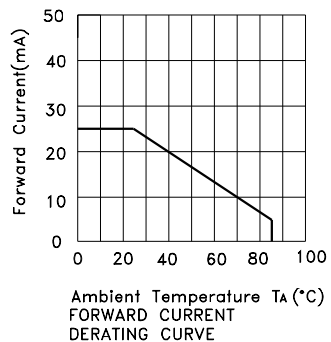
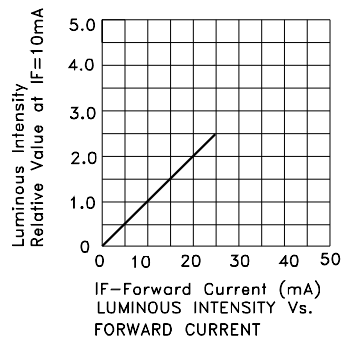
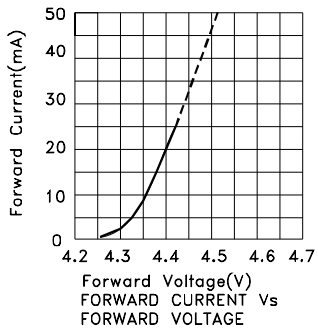

PACKING & LABEL SPECIFICATIONS

SBC23-11EGWA

