



www.soiseek.com — IC Seeker

IC Search

Try Luck

Tips: Try multiple keywords. e.g. Atmel 8 bit microcontroller

[IC Catalog](#) - [About Soiseek](#) - [Feedback](#)

[Make Soiseek Your Homepage](#)

Copyright Notice:

All the datasheets that Soiseek provides are edited by their manufacturers.

All copyrights of the datasheets reserved by their manufacturers.

Soiseek is NOT responsible for the correctness of any datasheet contents.

Please tell us if any advices. We are always dedicated to offering the best search experience.

Contact us: <http://www.soiseek.com/tellus>

Part Number: SA43-13SRWA

Super Bright Red

Features

- 0.43 INCH DIGIT HEIGHT.
- LOW CURRENT OPERATION.
- EXCELLENT CHARACTER APPEARANCE.
- EASY MOUNTING ON P.C. BOARDS OR SOCKETS.
- I.C. COMPATIBLE.
- MECHANICALLY RUGGED.
- STANDARD : GRAY FACE, WHITE SEGMENT.
- RoHS COMPLIANT.

Description

The Super Bright Red source color devices are made with Gallium Aluminum Arsenide Red Light Emitting Diode.

Package Dimensions& Internal Circuit Diagram

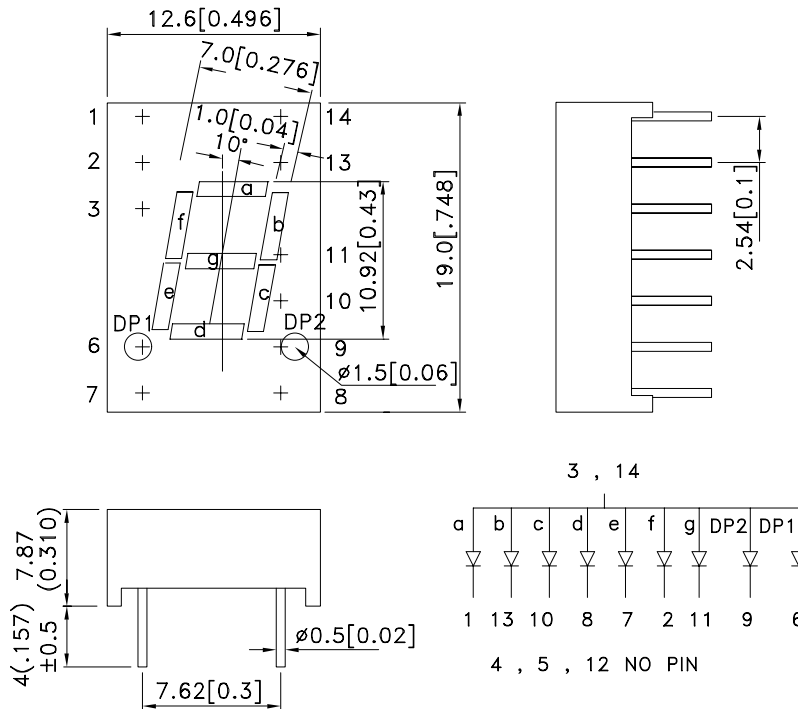

Notes:

1. All dimensions are in millimeters (inches), Tolerance is $\pm 0.25(0.01)$ unless otherwise noted.
2. Specifications are subject to change without notice.





Selection Guide

Part No.	Dice	Lens Type	Iv (ucd) [1] @ 10mA		Description
			Min.	Typ.	
SA43-13SRWA	Super Bright Red (GaAlAs)	WHITE DIFFUSED	8000	26000	Common Anode, Rt. &Lt. Hand Decimal.

Note:

1. Luminous intensity/ luminous Flux: +/-15%.

Electrical / Optical Characteristics at TA=25°C

Symbol	Parameter	Device	Typ.	Max.	Units	Test Conditions
λ_{peak}	Peak Wavelength	Super Bright Red	660		nm	I _F =20mA
λ_D [1]	Dominant Wavelength	Super Bright Red	640		nm	I _F =20mA
$\Delta\lambda_{1/2}$	Spectral Line Half-width	Super Bright Red	20		nm	I _F =20mA
C	Capacitance	Super Bright Red	45		pF	V _F =0V;f=1MHz
V _F [2]	Forward Voltage	Super Bright Red	1.85	2.5	V	I _F =20mA
I _R	Reverse Current	Super Bright Red		10	uA	V _R =5V

Notes:

- 1.Wavelength: +/-1nm.
2. Forward Voltage: +/-0.1V.

Absolute Maximum Ratings at TA=25°C

Parameter	Super Bright Red	Units
Power dissipation	75	mW
DC Forward Current	30	mA
Peak Forward Current [1]	155	mA
Reverse Voltage	5	V
Operating / Storage Temperature	-40°C To +85°C	
Lead Solder Temperature[2]	260°C For 3-5 Seconds	

Notes:

1. 1/10 Duty Cycle, 0.1ms Pulse Width.
2. 2mm below package base.

Kingbright

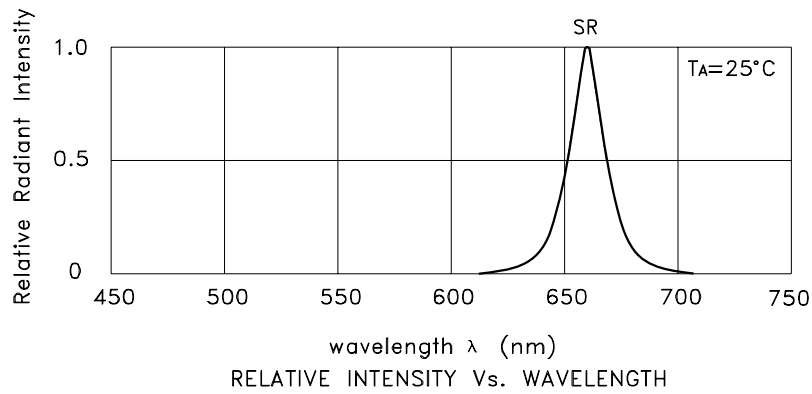

Super Bright Red

SA43-13SRWA

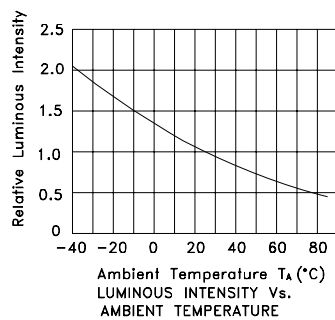
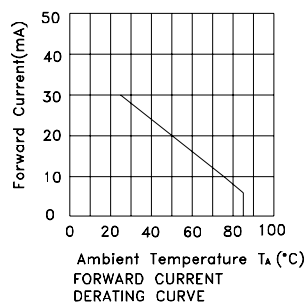
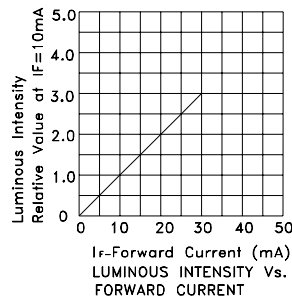
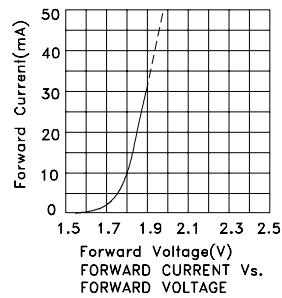

Kingbright

PACKING & LABEL SPECIFICATIONS

SA43-13SRWA

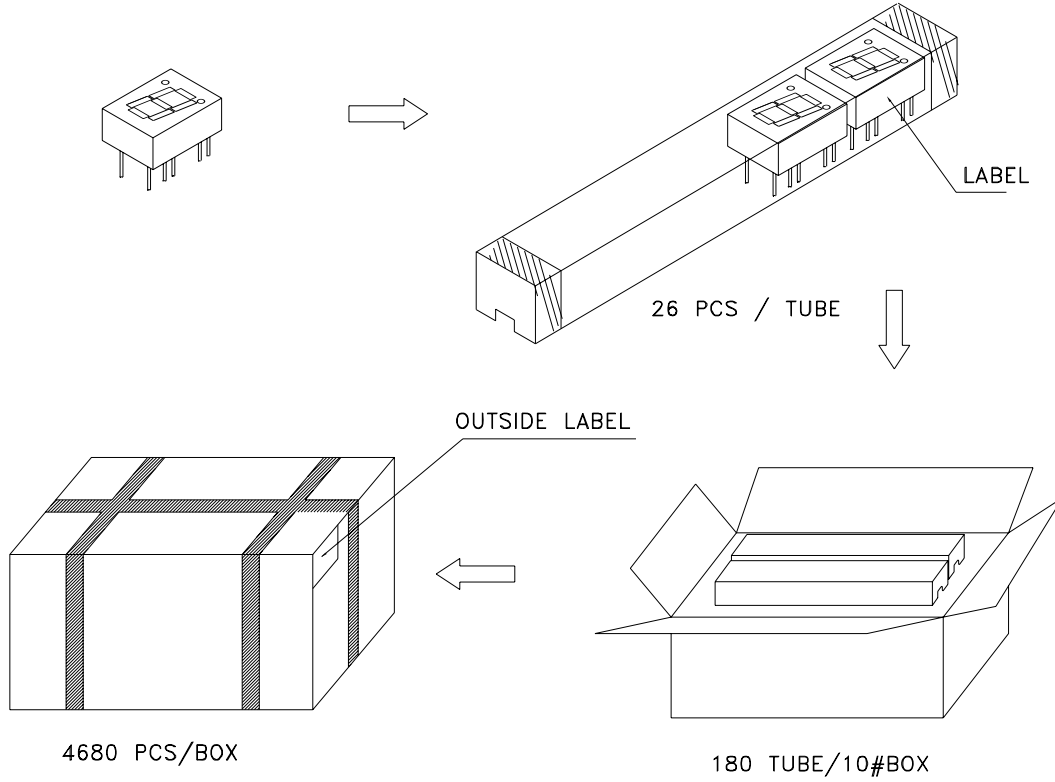

Inside LABEL Paste On The IC-TUBE

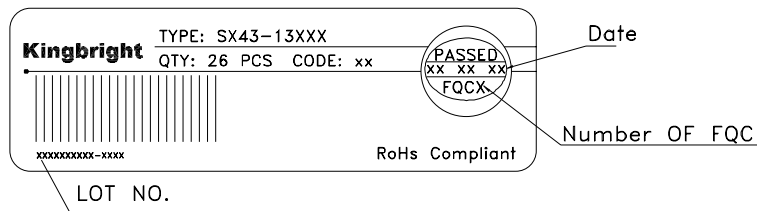

Outside LABEL Paste On The Box

