



ATTENTION
OBSERVE PRECAUTIONS
FOR HANDLING
ELECTROSTATIC
DISCHARGE
SENSITIVE
DEVICES

Features

- 3.2mmX1.6mm SMT LED, 1.8mm thickness.
- Low power consumption.
- Ideal for backlight and indicator.
- Various colors and lens types available.
- Package: 2000pcs / reel .
- Moisture sensitivity level : level 3.
- RoHS compliant.

Description

The Green source color devices are made with InGaN Light Emitting Diode.

Static electricity and surge damage the LEDs.

It is recommended to use a wrist band or anti-electrostatic glove when handling the LEDs.

All devices, equipment and machinery must be electrically grounded.

Package Dimensions

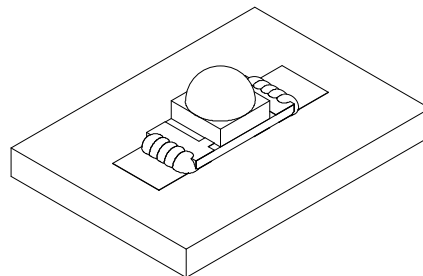
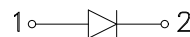
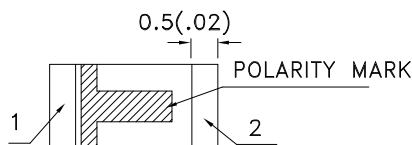
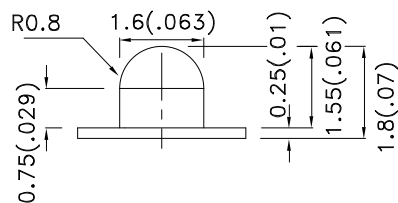
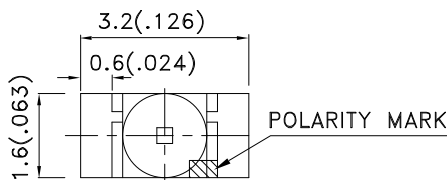

Notes:

1. All dimensions are in millimeters (inches).
2. Tolerance is $\pm 0.2(0.008)$ unless otherwise noted.
3. The specifications, characteristics and technical data described in the datasheet are subject to change without prior notice.
4. The device has a single mounting surface. The device must be mounted according to the specifications.



Selection Guide

Part No.	Dice	Lens Type	Iv (mcd) [2] @ 20mA		Viewing Angle [1]
			Min.	Typ.	2θ1/2
KPTD-3216ZGC-G	Green (InGaN)	Water Clear	3100	4200	50°

Notes:

1. θ1/2 is the angle from optical centerline where the luminous intensity is 1/2 of the optical peak value.
2. Luminous intensity/ luminous Flux: +/-15%.

Electrical / Optical Characteristics at TA=25°C

Symbol	Parameter	Device	Typ.	Max.	Units	Test Conditions
λ_{peak}	Peak Wavelength	Green	520		nm	I _F =20mA
λ_D [1]	Dominant Wavelength	Green	525		nm	I _F =20mA
$\Delta\lambda_{1/2}$	Spectral Line Half-width	Green	35		nm	I _F =20mA
C	Capacitance	Green	100		pF	V _F =0V;f=1MHz
V _F [2]	Forward Voltage	Green	3.2	4	V	I _F =20mA
I _R	Reverse Current	Green		50	uA	V _R =5V

Notes:

1. Wavelength: +/-1nm.
2. Forward Voltage: +/-0.1V.

Absolute Maximum Ratings at TA=25°C

Parameter	Green	Units
Power dissipation	120	mW
DC Forward Current	30	mA
Peak Forward Current [1]	100	mA
Reverse Voltage	5	V
Operating Temperature	-40°C To +85°C	
Storage Temperature	-40°C To +85°C	

Note:

1. 1/10 Duty Cycle, 0.1ms Pulse Width.

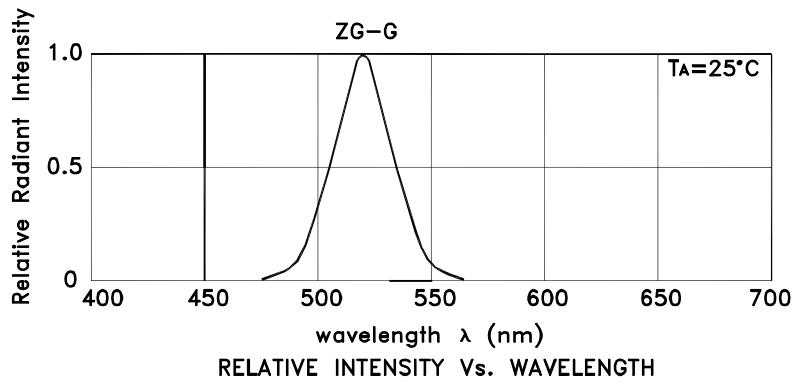

Green

KPTD-3216ZGC-G

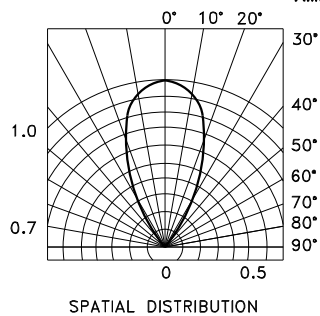
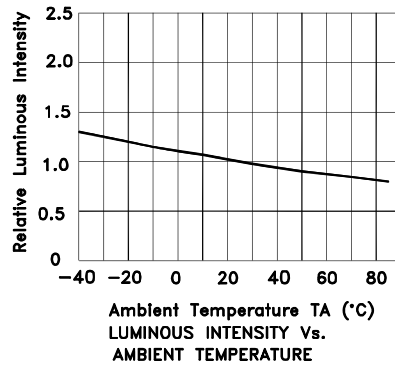
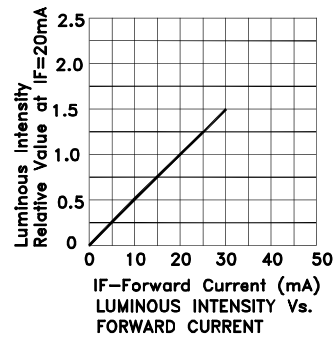

KPTD-3216ZGC-G

Reflow soldering is recommended and the soldering profile is shown below.
Other soldering methods are not recommended as they might cause damage to the product.

Reflow Soldering Profile For Lead-free SMT Process.



NOTES:

1. We recommend the reflow temperature 245°C(+/-5°C). The maximum soldering temperature should be limited to 260°C.
2. Don't cause stress to the epoxy resin while it is exposed to high temperature.
3. Number of reflow process shall be 2 times or less.

Recommended Soldering Pattern (Units : mm; Tolerance: ± 0.1)

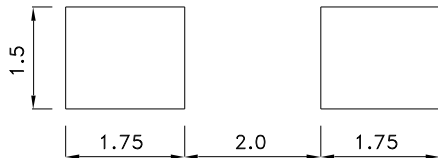

Reel Dimension



Tape Dimensions (Units : mm)

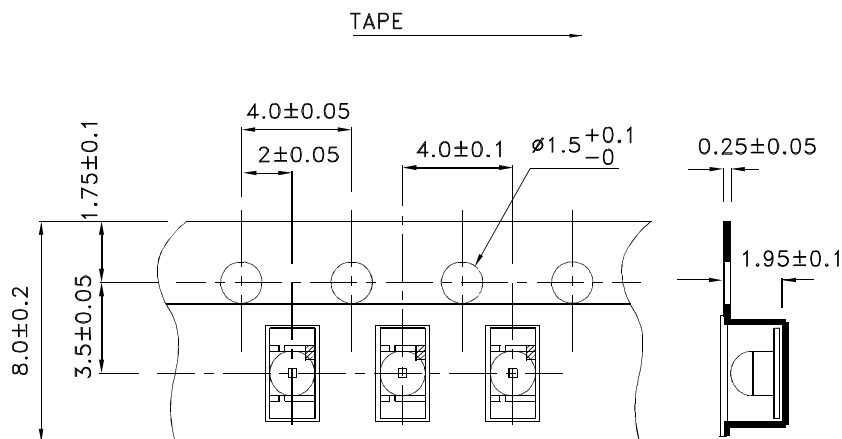

Kingbright

PACKING & LABEL SPECIFICATIONS

KPTD-3216ZGC-G

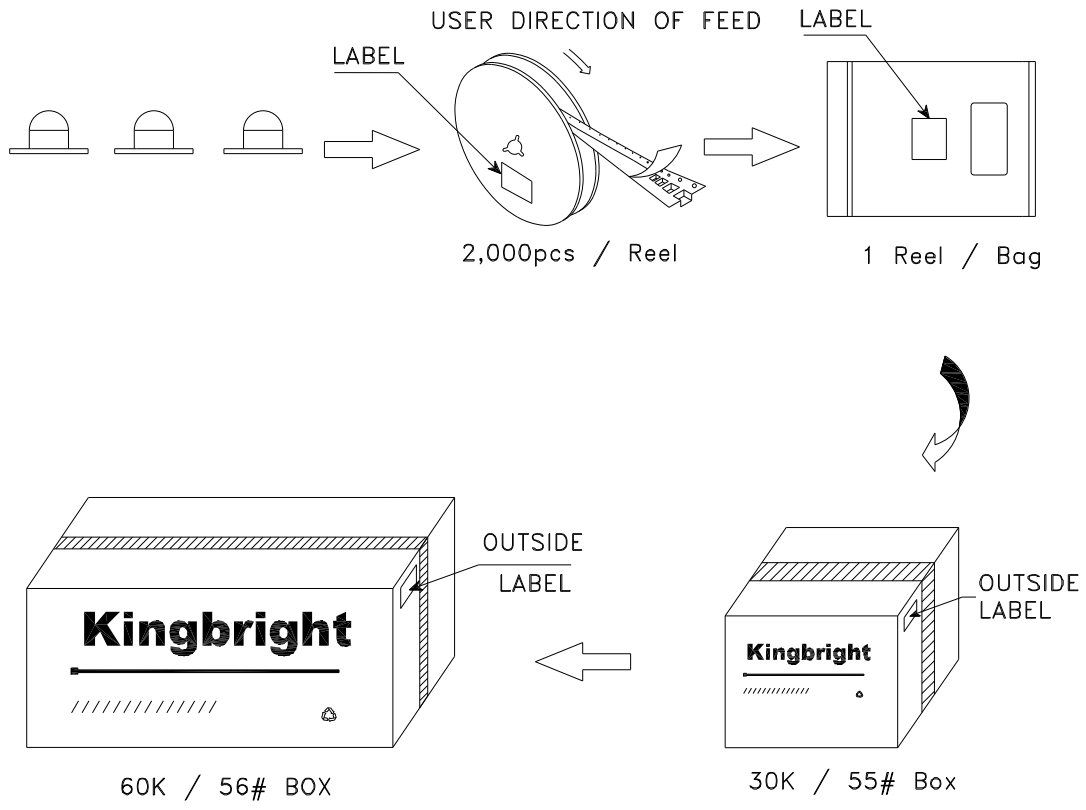

Kingbright	
P/NO: KPTD-3216xxx	
QTY: 2,000 pcs	Q.C. Q C xx xx xxxx PASSED
S/N: XXXX	
CODE: XXX	
LOT NO:	
 <small>xxxxxxxxxxxxxxxxxxxxxxxxxxxxxxxx</small>	
RoHS Compliant	