

Part Number: AAAF5051QR425Z3S-N1 Neutral White



ATTENTION
OBSERVE PRECAUTIONS
FOR HANDLING
ELECTROSTATIC
DISCHARGE
SENSITIVE
DEVICES

Features

- Suitable for all SMT assembly and solder process.
- Available on tape and reel.
- White SMD package, silicone resin.
- Package: 500pcs / reel.
- Moisture sensitivity level : level 3.
- RoHS compliant.

Description

The source color devices are made with InGaN on Al₂O₃ substrate Light Emitting Diode.
Static electricity and surge damage the LEDs.
It is recommended to use a wrist band or anti-electrostatic glove when handling the LEDs.
All devices, equipment and machinery must be electrically grounded.

Package Dimensions

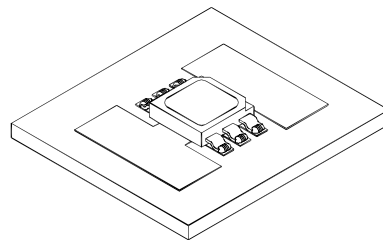
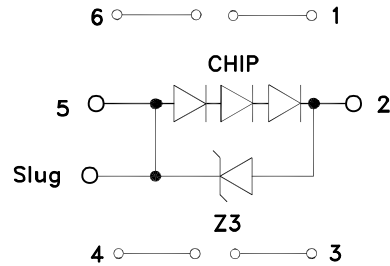
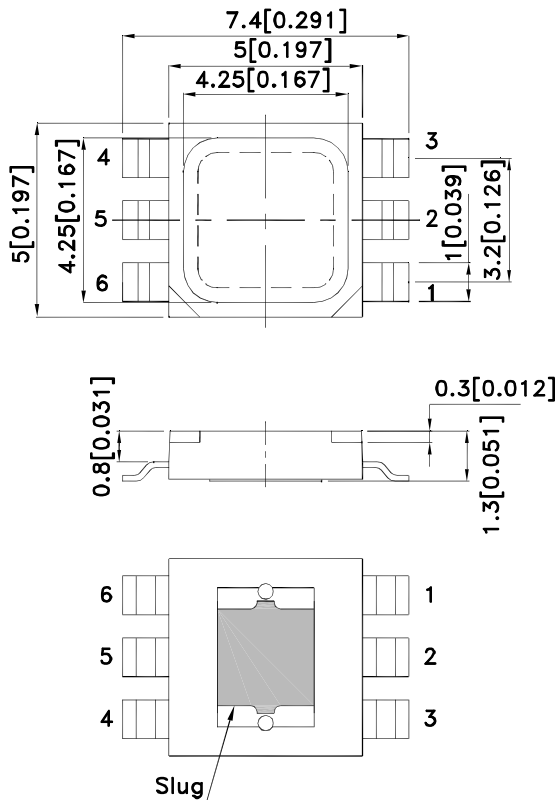

Notes:

1. All dimensions are in millimeters (inches).
2. Tolerance is $\pm 0.15[\pm 0.006]$ unless otherwise noted.
3. The specifications, characteristics and technical data described in the datasheet are subject to change without prior notice.
4. The device has a single mounting surface. The device must be mounted according to the specifications.



Handling Precautions

Compare to epoxy encapsulant that is hard and brittle, silicone is softer and flexible. Although its characteristic significantly reduces thermal stress, it is more susceptible to damage by external mechanical force.

As a result, special handling precautions need to be observed during assembly using silicone encapsulated LED products. Failure to comply might lead to damage and premature failure of the LED.

1. Handle the component along the side surfaces by using forceps or appropriate tools.

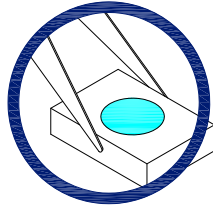

2. Do not directly touch or handle the silicone lens surface. It may damage the internal circuitry.

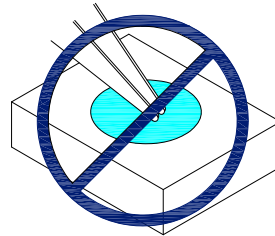
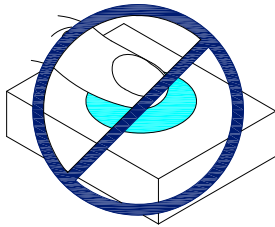

3. Do not stack together assembled PCBs containing exposed LEDs. Impact may scratch the silicone lens or damage the internal circuitry.

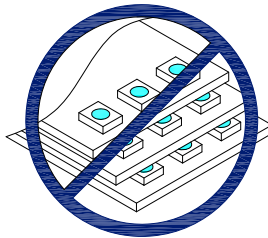

- 4.1. The inner diameter of the SMD pickup nozzle should not exceed the size of the LED to prevent air leaks.
- 4.2. A pliable material is suggested for the nozzle tip to avoid scratching or damaging the LED surface during pickup.
- 4.3. The dimensions of the component must be accurately programmed in the pick-and-place machine to insure precise pickup and avoid damage during production.

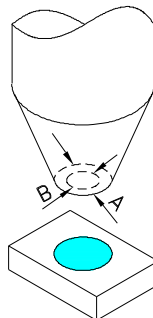

5. As silicone encapsulation is permeable to gases, some corrosive substances such as H_2S might corrode silver plating of leadframe. Special care should be taken if an LED with silicone encapsulation is to be used near such substances.

Selection Guide

Part No.	Dice	Lens Type	Iv (mcd) [2] @ 150mA		Φv (lm) [2] @ 150mA		Viewing Angle [1]
			Min.	Typ.	Min.	Typ.	2θ1/2
AAAF5051QR425Z3S-N1	Neutral White (InGaN)	Water Clear	20000	35000	60	75	120°

Notes:

1. θ1/2 is the angle from optical centerline where the luminous intensity is 1/2 of the optical peak value.
2. Luminous intensity/ luminous Flux: +/-15%.
3. Luminous intensity/ luminous Flux value is traceable to the CIE127-2007 compliant national standards.

Absolute Maximum Ratings at Ta=25°C

Parameter	Symbol	Value	Unit
Power dissipation	Pd	1.575	W
Junction temperature[1]	Tj	140	°C
Reverse Voltage	Vr	5	V
Operating Temperature	Top	-40 To +85	°C
Storage Temperature	Tstg	-40 To +85	°C
DC Forward Current [1]	If	150	mA
Peak Forward Current [2]	IfM	300	mA
Thermal resistance [1]	Rth j-a	90	°C/W
Electrostatic Discharge Threshold (HBM)		8000	V

Notes:

1. Results from mounting on metal core PCB, mounted on pc board-metal core PCB is recommend. for lowest thermal resistance.
2. 1/10 Duty Cycle, 0.1ms Pulse Width.

Electrical / Optical Characteristics at Ta=25°C

Parameter	Symbol	Value	Unit
Reverse Current (Vr = 5V) [Max.]	Ir	10	uA
Color Temperature If=150mA [Min.]	CCT	3710	K
Color Temperature If=150mA [Typ.]		4000	
Color Temperature If=150mA [Max.]		4260	
Forward Voltage If=150mA [Min.]	Vf [1]	8.5	V
Forward Voltage If=150mA [Typ.]		9.5	
Forward Voltage If=150mA [Max.]		10.5	
Temperature coefficient of x If=150mA, -10 ° C ≤ T ≤ 100 ° C [Typ.]	TCx	-2	10 ⁻³ /° C
Temperature coefficient of y If=150mA, -10 ° C ≤ T ≤ 100 ° C [Typ.]	TCy	-1	10 ⁻³ /° C
Temperature coefficient of Vf If=150mA, -10 ° C ≤ T ≤ 100 ° C [Typ.]	TCv	-2.3	mV/° C

Note:

1. Forward Voltage: +/-0.1V.

Neutral White

AAAF5051QR425Z3S-N1

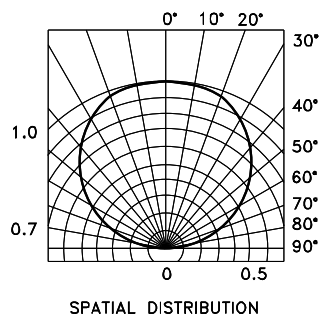
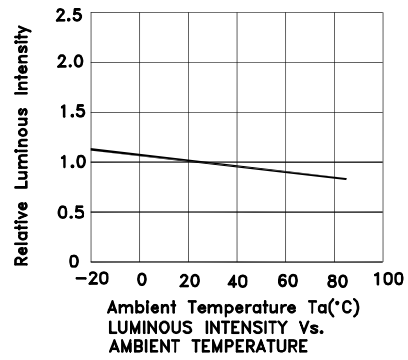
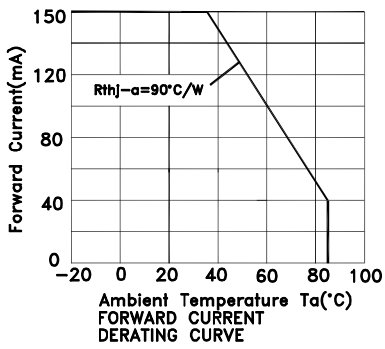
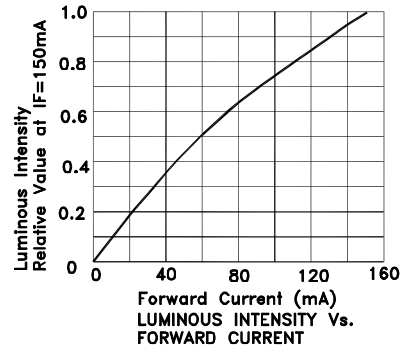
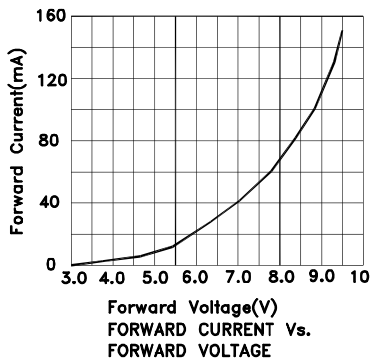

CCT 2500-7000 K Bin Code

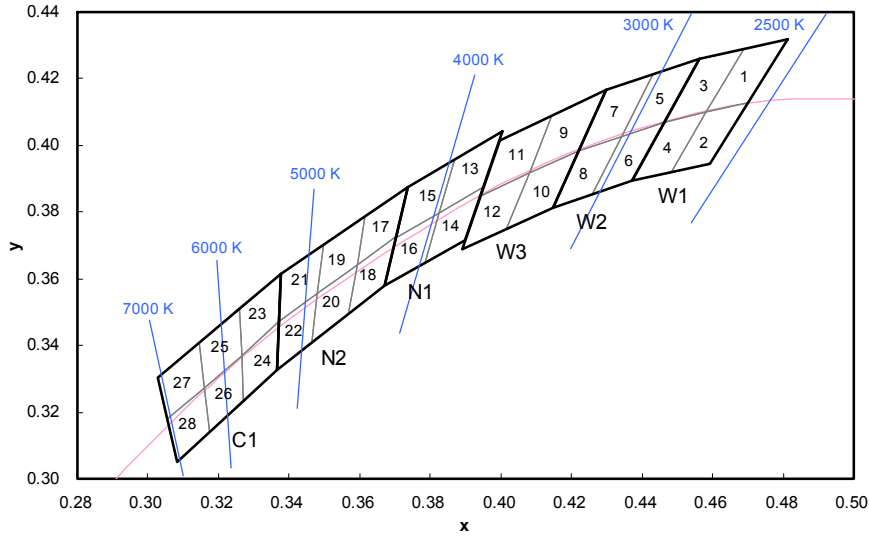

Group	Chromaticity Regions	CCT (K)		
		Min.	Typ.	Max.
W1	1, 2, 3, 4	2580	2700	2870
W2	5, 6, 7, 8	2870	3000	3220
W3	9, 10, 11, 12	3220	3500	3710
N1	13, 14, 15, 16	3710	4000	4260
N2	17, 18, 19, 20, 21, 22	4260	4700	5310
C1	23, 24, 25, 26, 27, 28	5310	6000	7040

Notes:
 Shipment may contain more than one chromaticity regions.
 Orders for single chromaticity region are generally not accepted.
 Measurement tolerance of the chromaticity coordinates is ± 0.01 .

	x	y		x	y		x	y		x	y
1	0.4582	0.4099	8	0.4147	0.3814	15	0.3702	0.3722	22	0.3481	0.3557
	0.4687	0.4289		0.4221	0.3984		0.3736	0.3874		0.3370	0.3472
	0.4813	0.4319		0.4342	0.4028		0.3869	0.3958		0.3364	0.3328
	0.4700	0.4126		0.4259	0.3853		0.3825	0.3798		0.3466	0.3411
2	0.4483	0.3919	9	0.4080	0.3916	16	0.3670	0.3578	23	0.3376	0.3616
	0.4582	0.4099		0.4146	0.4089		0.3702	0.3722		0.3260	0.3512
	0.4700	0.4126		0.4299	0.4165		0.3825	0.3798		0.3265	0.3371
	0.4593	0.3944		0.4221	0.3984		0.3783	0.3646		0.3370	0.3472
3	0.4465	0.4071	10	0.4017	0.3751	17	0.3736	0.3874	24	0.3370	0.3472
	0.4562	0.4260		0.4080	0.3916		0.3616	0.3788		0.3265	0.3371
	0.4687	0.4289		0.4221	0.3984		0.3592	0.3641		0.3270	0.3230
	0.4582	0.4099		0.4147	0.3814		0.3703	0.3726		0.3364	0.3328
4	0.4373	0.3893	11	0.3941	0.3848	18	0.3703	0.3726	25	0.3260	0.3512
	0.4465	0.4071		0.3996	0.4015		0.3592	0.3641		0.3144	0.3408
	0.4582	0.4099		0.4146	0.4089		0.3568	0.3495		0.3160	0.3274
	0.4483	0.3919		0.4080	0.3916		0.3670	0.3578		0.3265	0.3371
5	0.4342	0.4028	12	0.3889	0.3690	19	0.3616	0.3788	26	0.3265	0.3371
	0.4430	0.4212		0.3941	0.3848		0.3496	0.3702		0.3160	0.3274
	0.4562	0.4260		0.4080	0.3916		0.3481	0.3557		0.3175	0.3139
	0.4465	0.4071		0.4017	0.3751		0.3592	0.3641		0.3270	0.3230
6	0.4259	0.3853	13	0.3825	0.3798	20	0.3592	0.3641	27	0.3144	0.3408
	0.4342	0.4028		0.3869	0.3958		0.3481	0.3557		0.3028	0.3304
	0.4465	0.4071		0.4006	0.4044		0.3466	0.3411		0.3055	0.3177
	0.4373	0.3893		0.3950	0.3875		0.3568	0.3495		0.3160	0.3274
7	0.4221	0.3984	14	0.3783	0.3646	21	0.3496	0.3702	28	0.3160	0.3274
	0.4299	0.4165		0.3825	0.3798		0.3376	0.3616		0.3055	0.3177
	0.4430	0.4212		0.3950	0.3875		0.3370	0.3472		0.3081	0.3049
	0.4342	0.4028		0.3898	0.3716		0.3481	0.3557		0.3175	0.3139

AAAF5051QR425Z3S-N1

Reflow soldering is recommended and the soldering profile is shown below.
Other soldering methods are not recommended as they might cause damage to the product.

Reflow Soldering Profile For Lead-free SMT Process.

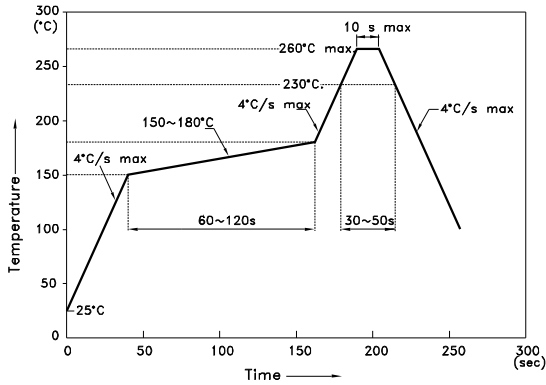

Reel Dimension

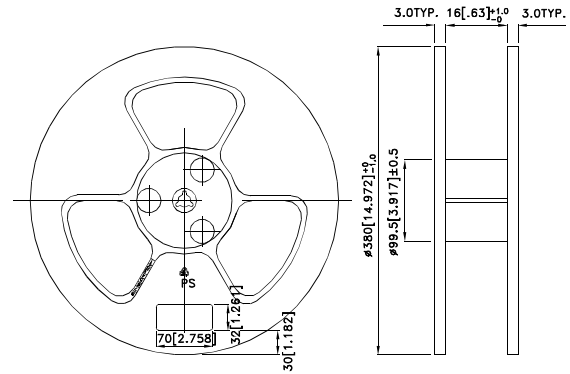

NOTES:

1. We recommend the reflow temperature 245°C (+/-5°C). The maximum soldering temperature should be limited to 260°C.
2. Don't cause stress to the epoxy resin while it is exposed to high temperature.
3. Number of reflow process shall be 2 times or less.

Recommended Soldering Pattern

(Units : mm; Tolerance: ± 0.1)

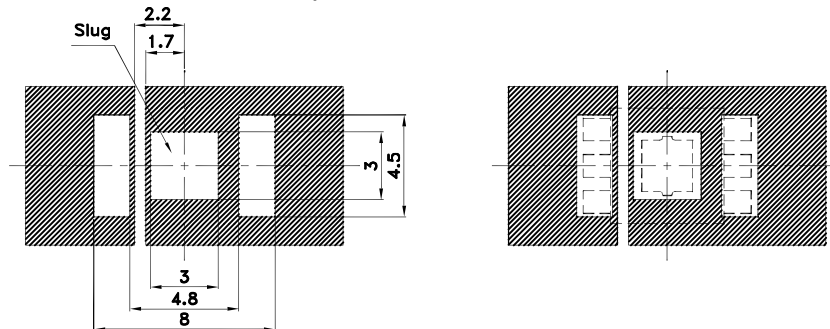

Tape Specifications

(Units : mm)

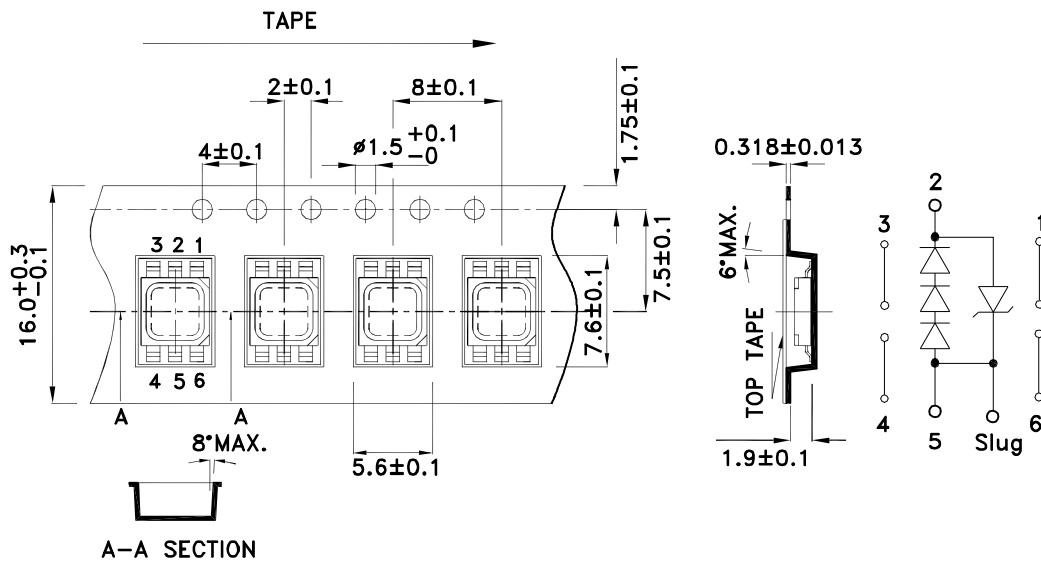

Kingbright

PACKING & LABEL SPECIFICATIONS

AAAF5051QR425Z3S-N1

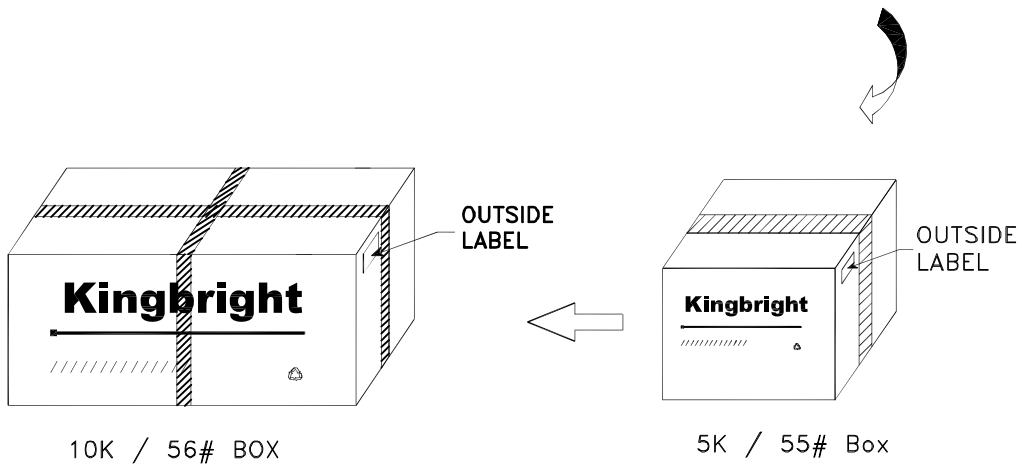
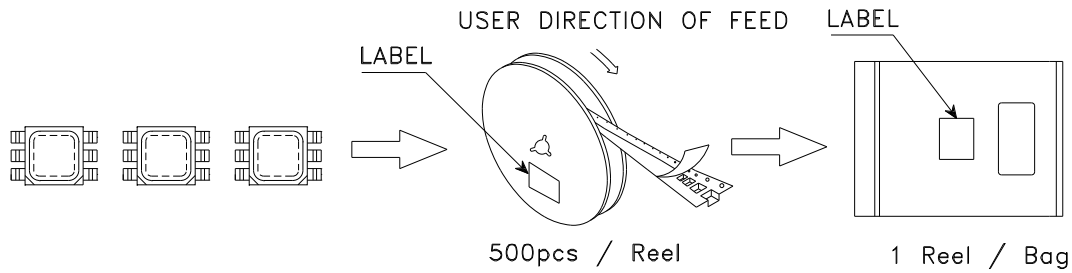

<h1>Kingbright</h1>	
P/NO: AAAF5051xxx	
QTY: 500 pcs	Q.C. Q C xx xx xxxx PASSED
S/N: XXXX	
CODE: XXX	
LOT NO:	
 xxxxxxxxxxxxxxxxxxxxxxxx	
RoHS Compliant	