



EVERLIGHT ELECTRONICS CO.,LTD.

Device Number : CDDD-512-015 REV: 2

0.56" Dual Digit Displays

PART NO. : ELD-512EWA/P4 ECN : _____ Page: 1/5

■ Features :

- Industrial standard size.
- Low power consumption.
- Categorized for luminous intensity.

■ Applications:

- Audio equipment
- Instrument panels
- Digital read out display

■ Descriptions :

- The ELD-512 series is a large 14.22 mm (0.56")high seven segment display designed for viewing distances up to 7 meters.
- These displays provide excellent reliability in bright ambient light.
- These devices are made with white segments and gray surface.

PART NO.	Chip	
	Material	Emitted Color
ELD-512EWA/P4	GaAsP/GaP	Orange

OFFICE : NO. 25,Lane 76,Sec.3, Chung Yang Rd., Tucheng 236, Taipei, Taiwan, R.O.C.

TEL : 886-2-2267-2000,2267-9936

FAX : 886-2-2267-6244,22676189,22676306

<http://www.everlight.com>



0.56" Dual Digit Displays

PART NO. : ELD-512EWA/P4

ECN :

Page: 2/5

Package Dimensions:

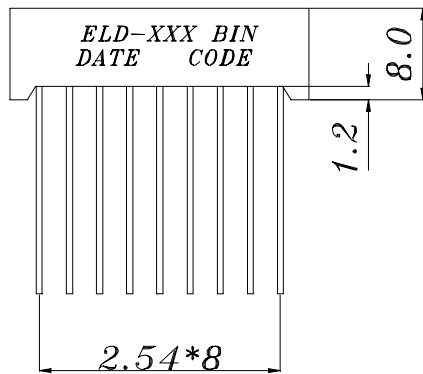
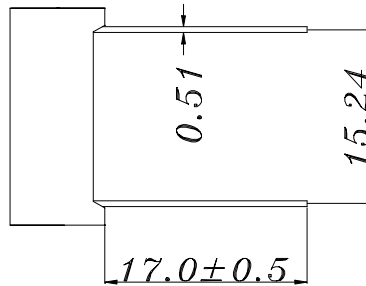
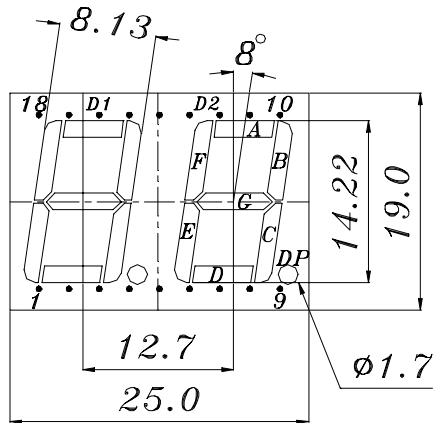

COMMON ANODE

- 1 CATHODE E D1
- 2 CATHODE D D1
- 3 CATHODE C D1
- 4 CATHODE DP D1
- 5 CATHODE E D2
- 6 CATHODE D D2
- 7 CATHODE G D2
- 8 CATHODE C D2
- 9 CATHODE DP D2
- 10 CATHODE B D2
- 11 CATHODE A D2
- 12 CATHODE F D2
- 13 COMMON ANODE D2
- 14 COMMON ANODE D1
- 15 CATHODE B D1
- 16 CATHODE A D1
- 17 CATHODE G D1
- 18 CATHODE F D1

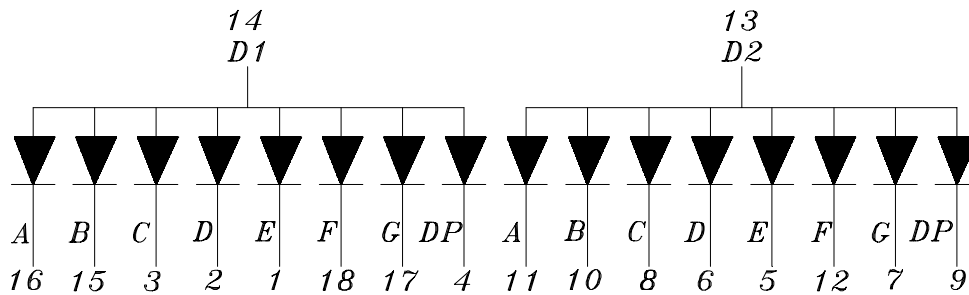

Notes:

- 1.All dimensions are in millimeters , tolerance is 0.25mm unless otherwise noted.
 - 2.Above specification may be changed without notice.
- Supplier will reserve authority on material change for above specification.



EVERLIGHT ELECTRONICS CO.,LTD.

Device Number : CDDD-512-015 REV: 2

0.56" Dual Digit Displays

PART NO. : ELD-512EWA/P4 ECN : Page: 3/5

■ Absolute maximum ratings at Ta = 25°C :

Parameter	Symbol	Rating	Unit
Reverse Voltage	VR	5	V
Forward Current	IF	30	mA
Operating Temperature	Topr	-40 to +85	°C
Storage Temperature	Tstg	-40 to +100	°C
Soldering Temperature	Tsol	260 ± 5	°C
Power Dissipation	Pd	100	mW
Peak Forward Current(Duty 1/10 @ 1KHZ)	IF(Peak)	160	mA

■ Electronic optical characteristics :

Parameter		Symbol	Min.	Typ.	Max.	Unit	Condition
Luminous Intensity	Per segment	Iv	1.05	2.0	----	mcd	IF=10mA
	Per decimal point		0.3	0.6	----		
Peak Wavelength		λp	----	635	----	nm	IF=20mA
Dominant Wavelength		λd	----	625	----	nm	IF=20mA
Spectrum Radiation	Bandwidth	$\Delta \lambda$	----	45	----	nm	IF=20mA
Forward Voltage		VF	1.7	2.0	2.4	V	IF=20mA
Reverse Current		IR	----	----	10	μA	VR=5V



EVERLIGHT ELECTRONICS CO.,LTD.

Device Number : CDDD-512-015

REV: 2

0.56" Dual Digit Displays

PART NO. : ELD-512EWA/P4

ECN :

Page: 4/5

Typical Electro-Optical Characteristic Curves:

CHIP Material:GaAsP/GaP
Emitted Color:Hi-Eff Red/Orange

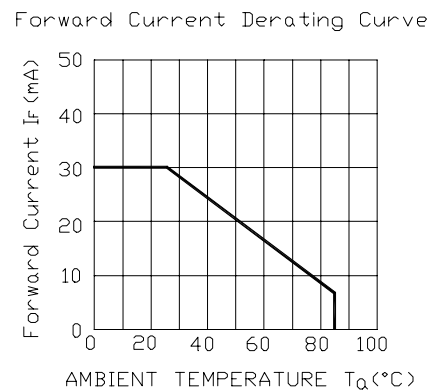
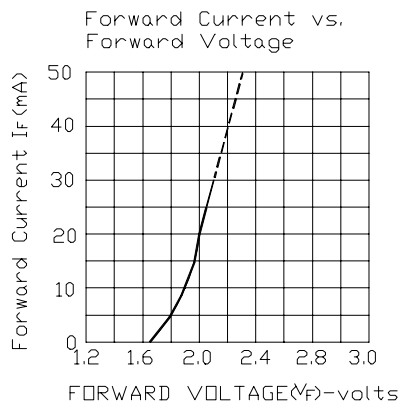
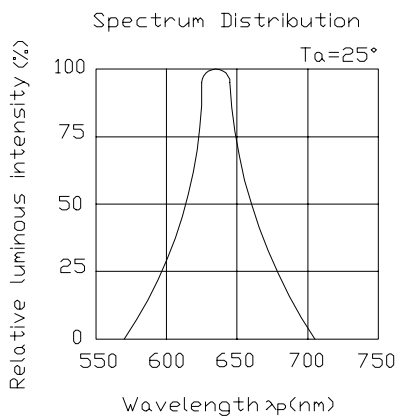



EVERLIGHT ELECTRONICS CO.,LTD.

Device Number : CDDD-512-015 REV: 2

0.56" Dual Digit Displays

PART NO. : ELD-512EWA/P4 ECN : Page: 5/5

■ Reliability test items and conditions:

NO	Item	Test Conditions	Test Hours/Cycle	Sample Size	Ac/Re
1	Solder Heat	TEMP : 260°C ± 5 °C	5 SEC	76 PCS	0/1
2	Temperature Cycle	H : +85°C 30min ∫ 5 min L : -55°C 30min	50 CYCLE	76 PCS	0/1
3	Thermal Shock	H : +100°C 5min ∫ 10 sec L : -10°C 5min	50 CYCLE	76 PCS	0/1
4	High Temperature Storage	TEMP : 100°C	1000 HRS	76 PCS	0/1
5	Low Temperature Storage	TEMP : -55°C	1000 HRS	76 PCS	0/1
6	DC Operating Life	IF = 10 mA	1000 HRS	76 PCS	0/1
7	High Temperature / High Humidity	85°C /85% RH	1000 HRS	76 PCS	0/1

--	--	--	--	--	--