

## Technical Data Sheet

### Top View LEDs

**67-21RAC/B102/TR8/AM**

#### Features

- Pb-free.
- Inner reflector.
- White package.
- Optical indicator.
- P-LCC-2 package.
- Wide viewing angle.
- Colorless clear resin.
- Precondition : According to JEDEC Level-2.
- ESD : Up to 2KV. (According to JESD22-A114-B)
- The product itself will remain within RoHS compliant version.
- Soldering methods : IR reflow and wave soldering.



#### Descriptions

- The 67-21 series is available for orange, green, blue and yellow or other color due to the different raw material.
- Base on the package design, the device result in wide view angle.

#### Applications

- Automotive backlighting or indicator : Dashboard, switch, audio and video equipments...etc.
- Backlight : LCD, switches, symbol, mobile phone and illuminated advertising.
- Display for indoor and outdoor application.
- Ideal for coupling into light guides.
- Substitution of traditional light.
- Optical indicator.
- General applications.

#### Device Selection Guide

Chip	Emitted Color	Resin Color
Material		
AlGaInP	Dark Red	Water Clear

Technical Data Sheet

Top View LEDs

67-21RAC/B102/TR8/AM

Package Dimension

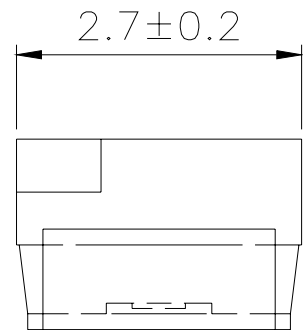
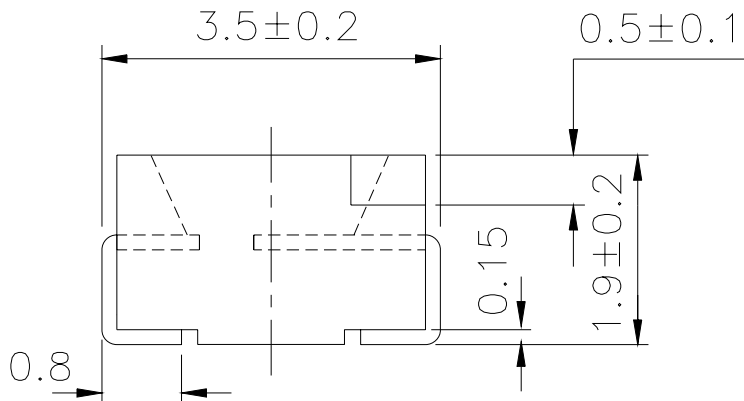
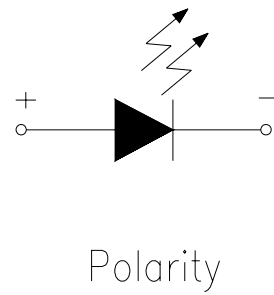
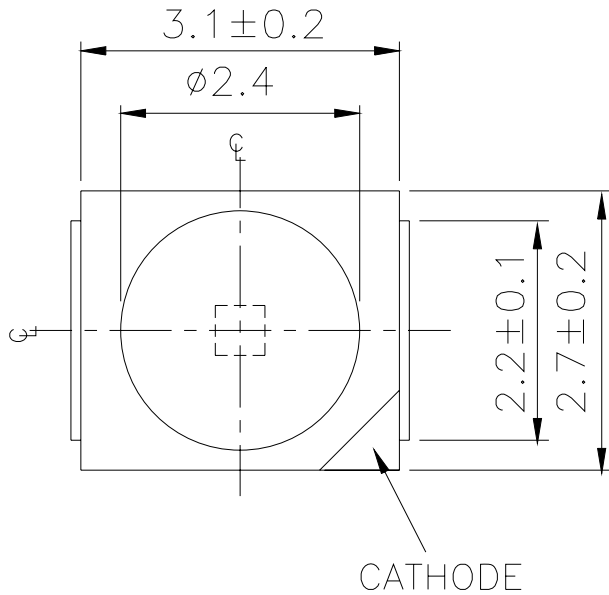

Note : Tolerances unless dimension ±0.1mm. Unit = mm

**Technical Data Sheet****Top View LEDs****67-21RAC/B102/TR8/AM****Absolute Maximum Ratings (Ta=25°C)**

Parameter	Symbol	Rating	Unit
Reverse Voltage	V <sub>R</sub>	12	V
Forward Current	I <sub>F</sub>	30	mA
Peak Forward Current ( $t \leq 10\mu\text{s}$ , $D = 0.1$ )	I <sub>FP</sub>	1	A
Power Dissipation	P <sub>d</sub>	120	mW
Junction Temperature	T <sub>j</sub>	115	°C
Operating Temperature	T <sub>opr</sub>	-40 ~ +100	°C
Storage Temperature	T <sub>stg</sub>	-40 ~ +110	°C
Thermal resistance	R <sub>th J-A</sub>	400	K/W
	R <sub>th J-S</sub>	180	K/W
Soldering Temperature	T <sub>sol</sub>	Reflow Soldering : 260 °C for 10 sec. Hand Soldering : 350 °C for 3 sec.	

**Technical Data Sheet****Top View LEDs****67-21RAC/B102/TR8/AM****Electro-Optical Characteristics (Ta=25°C)**

Parameter	Symbol	Min.	Typ.	Max.	Unit	Condition
Luminous Intensity	I <sub>v</sub>	180	-----	560	mcd	I <sub>F</sub> =30mA
Viewing Angle	2θ <sub>1/2</sub>	-----	120	-----	deg	I <sub>F</sub> =30mA
Peak Wavelength	λ <sub>p</sub>	-----	633	-----	nm	I <sub>F</sub> =30mA
Dominant Wavelength	λ <sub>d</sub>	624	-----	636	nm	I <sub>F</sub> =30mA
Spectrum Radiation Bandwidth	Δλ	-----	20	-----	nm	I <sub>F</sub> =30mA
Forward Voltage	V <sub>F</sub>	1.75	2.0	2.35	V	I <sub>F</sub> =30mA
Reverse Current	I <sub>R</sub>	-----	0.2	10	μA	V <sub>R</sub> =12V
Temperature coefficient of λ <sub>p</sub>	TC <sub>λ<sub>p</sub></sub>	-----	0.11	-----	nm/K	I <sub>F</sub> =30mA
Temperature coefficient of λ <sub>d</sub>	TC <sub>λ<sub>d</sub></sub>	-----	0.04	-----	nm/K	I <sub>F</sub> =30mA
Temperature coefficient of V <sub>F</sub>	TC <sub>V</sub>	-----	-1.7	-----	mV/K	I <sub>F</sub> =30mA

## Notes :

1. Tolerance of Luminous Intensity : ±11%
2. Tolerance of Dominant Wavelength : ±1nm
3. Tolerance of Forward Voltage : ±0.1V

**Technical Data Sheet****Top View LEDs****67-21RAC/B102/TR8/AM****Bin Range of Luminous Intensity**

Bin Code	Min.	Max.	Unit	Condition
S1	180	224	mcd	I <sub>F</sub> =30mA
S2	224	280		
T1	280	355		
T2	355	450		
U1	450	560		

Notes : Tolerance of Luminous Intensity :  $\pm 11\%$ **Bin Range of Dominant Wavelength**

Bin Code	Min.	Max.	Unit	Condition
1	624	627	nm	I <sub>F</sub> =30mA
2	627	630		
3	630	633		
4	633	636		

Notes : Tolerance of Dominant Wavelength :  $\pm 1\text{nm}$

**Technical Data Sheet**

**Top View LEDs**

**67-21RAC/B102/TR8/AM**

**Typical Electro-Optical Characteristics Curves(Ta=25°C)**

**Typical Curve of Spectral Distribution:**

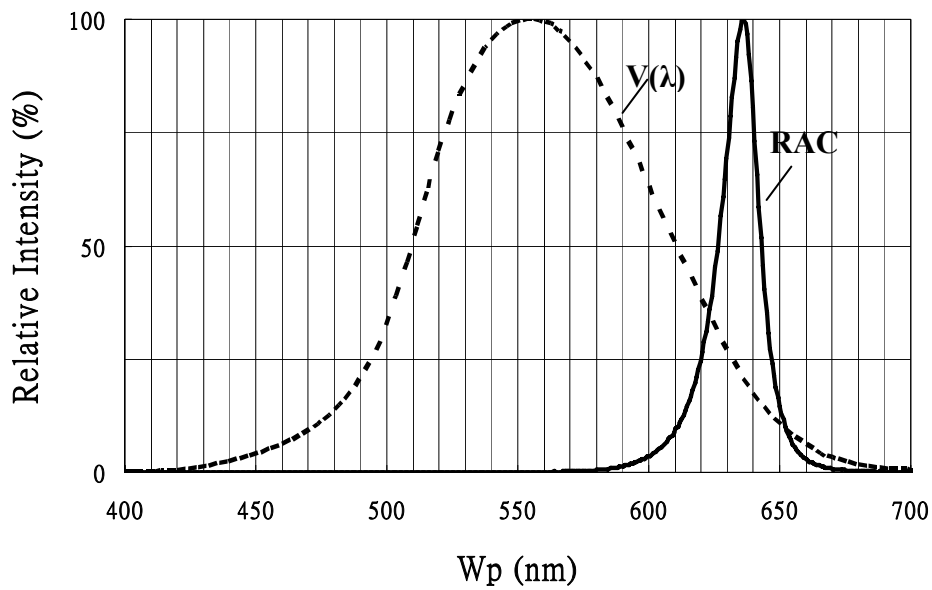

Note : V(λ)=Standard eye response curve ; IF=30mA

**Diagram Characteristics of Radiation**

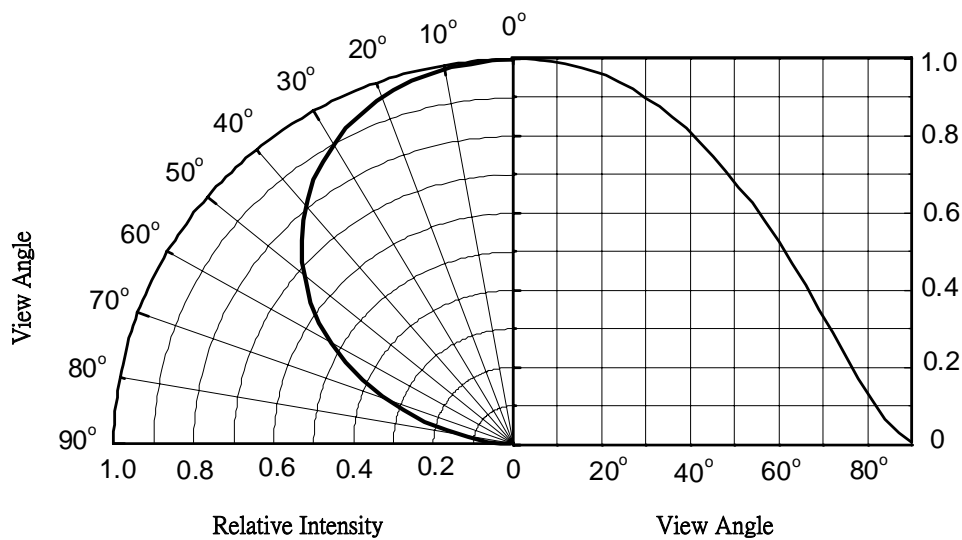



# Technical Data Sheet

## Top View LEDs

**67-21RAC/B102/TR8/AM**

Forward Current vs. Forward Voltage (Ta=25°C)

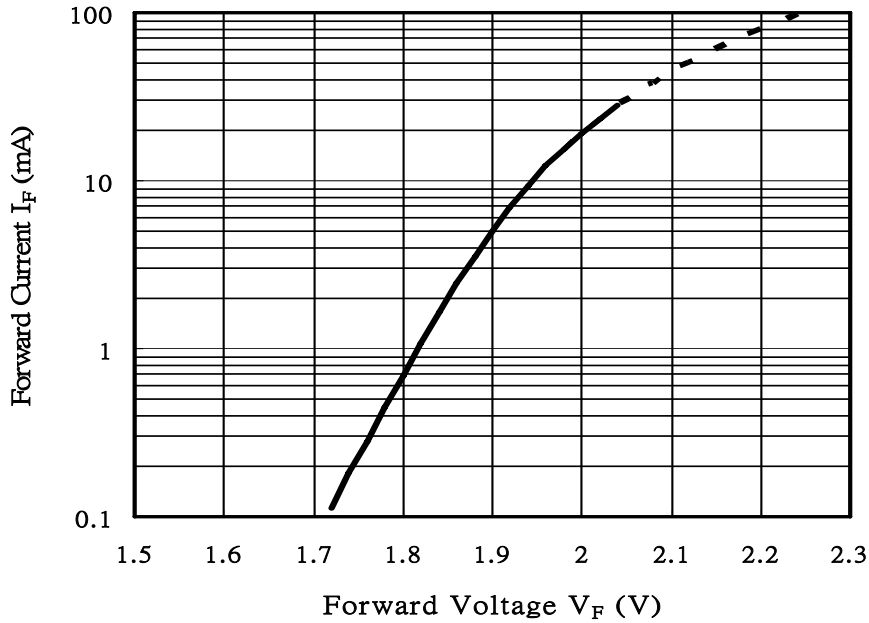

Forward Current vs. Ambient Temperature

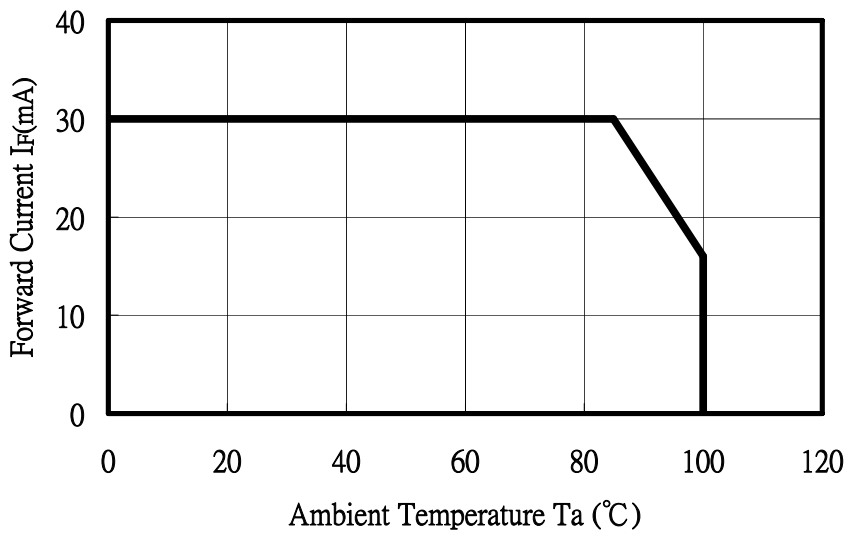

## Technical Data Sheet

### Top View LEDs

**67-21RAC/B102/TR8/AM**

#### Relative Luminous Intensity vs. Junction Temperature

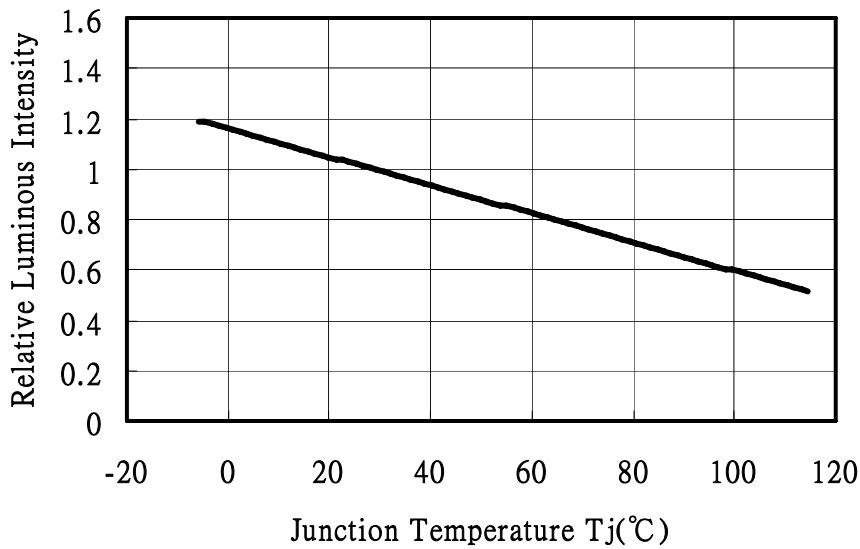

Note :  $f(T_j) = I_v / I_v(25^\circ\text{C}) ; I_F=30\text{mA}$

#### Relative Forward Voltage vs. Junction Temperature

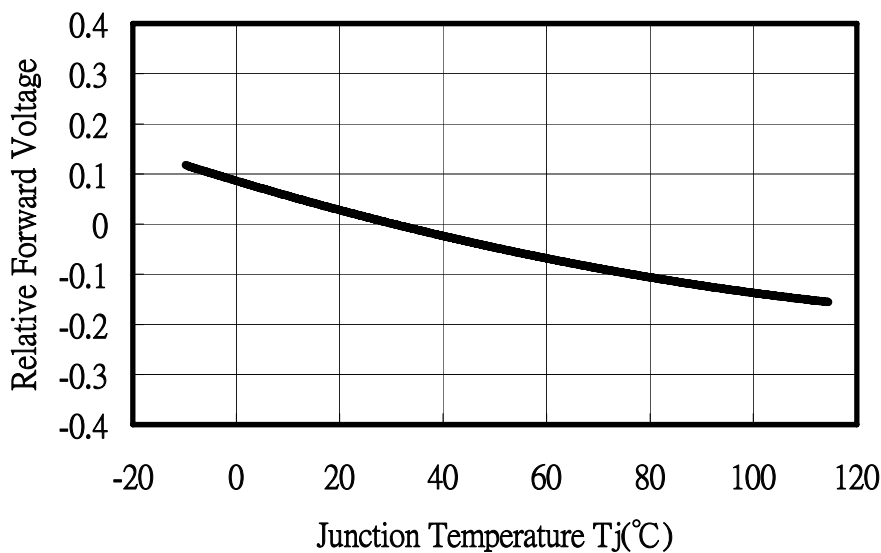

Note :  $\Delta V_F = V_F - V_F(25^\circ\text{C}) = f(T_j) ; I_F=30\text{mA}$





Technical Data Sheet

Top View LEDs

**67-21RAC/B102/TR8/AM**

Carrier Tape Dimensions: Loaded Quantity 2000 PCS Per Reel

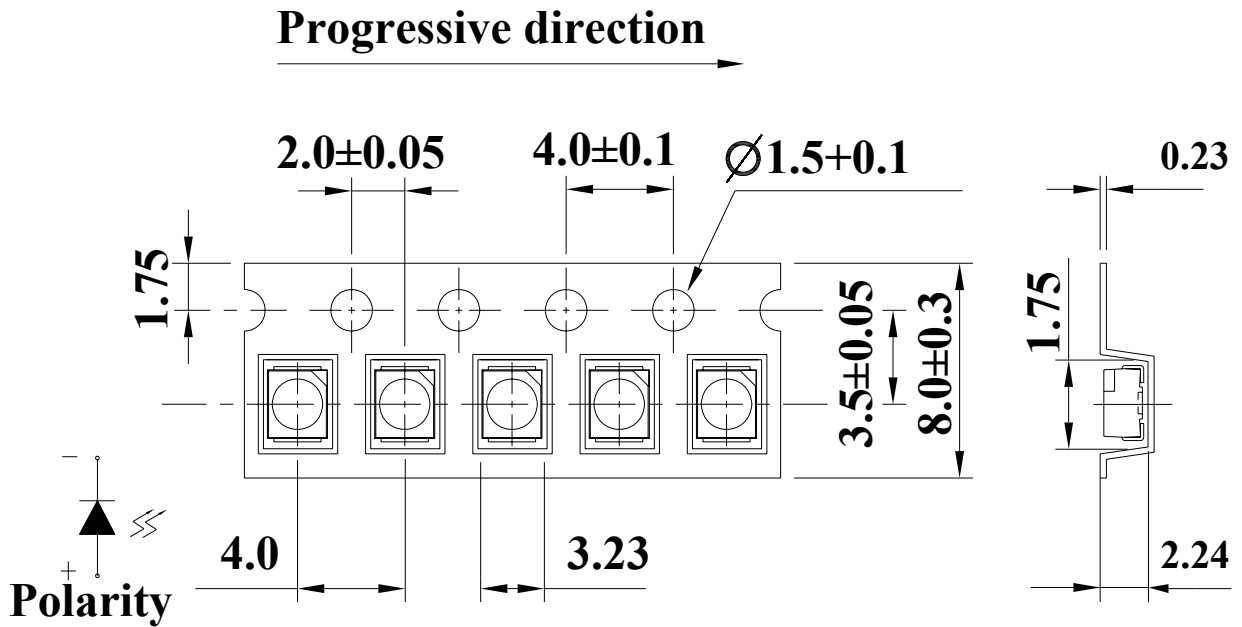

Note : Tolerances unless dimension  $\pm 0.1$ mm. Unit = mm

Moisture Resistant Packaging Process and Materials

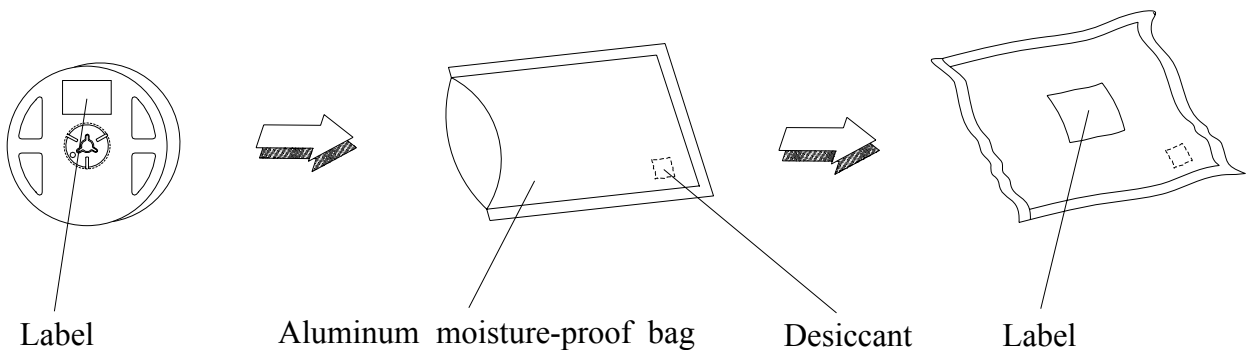

**Technical Data Sheet**

**Top View LEDs**

**67-21RAC/B102/TR8/AM**

**Precautions for Use**

1. Soldering Condition

1.1 (A) Pb-free solder temperature profile

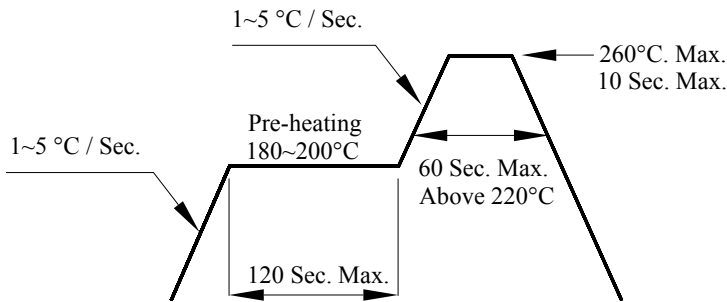

(B) Recommend soldering pad

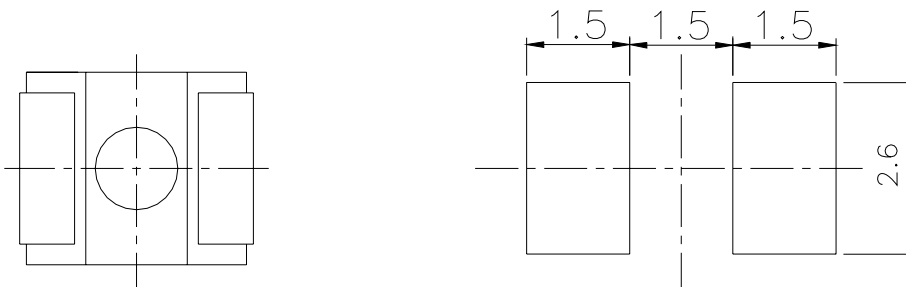

Note : Tolerances unless dimension  $\pm 0.1$ mm. Unit = mm

- 1.2 Reflow soldering should not be done more than two times.
- 1.3 When soldering, do not put stress on the LED during heating.
- 1.4 After soldering, do not warp the circuit board.

2. Over-current-proof

Customer must apply resistors for protection, otherwise slight voltage shift will cause big current change ( Burn out will happen ).

3. Storage

- 3.1 Do not open moisture proof bag before the products are ready to use.
- 3.2 Before opening the package: The LED should be kept at 30°C or less and 90%RH or less.



## Technical Data Sheet

### Top View LEDs

#### 67-21RAC/B102/TR8/AM

3.3 After opening the package: The LED floor life is 1 year under 30°C or less and 60% RH or less. If unused LED remain, it should be stored in moisture proof packages.

3.4 If the moisture absorbent material (silica gel) has faded away or the LED have exceeded the storage time, baking treatment should be performed using the following conditions.

Baking treatment : 60±5°C for 24 hours.

#### 4.Soldering Iron

Each terminal is to go to the tip of soldering iron temperature less than 350°C for 3 seconds within once in less than the soldering iron capacity 25W. Leave two seconds and more intervals, and do soldering of each terminal. Be careful because the damage of the product is often started at the time of the hand solder.