

Technical Data Sheet

Top View LEDs

67-11/T2C-EU2W1M/2T

Features

- Fluorescence Type
- High Luminous Intensity
- High Efficiency
- Emission Color:x=0.29,y=0.30
- ESD protection.
- Pb-free
- The product itself will remain within RoHS compliant version.



Descriptions

The white LED which was fabricated using a blue LED and a phosphor, and the phosphor is excited by blue light and emits yellow fluorescence. The mixture of blue light and yellow light results in a white emission.

Applications

- OA Equipment
- Backlighting of Full Color LCD
- Replacement of Conventional Light Bulbs and Fluorescent Lamps

Device Selection Guide

Chip		Lens Color
Material	Emitted Color	
InGaN	Blue	Water Clear

Package Dimensions

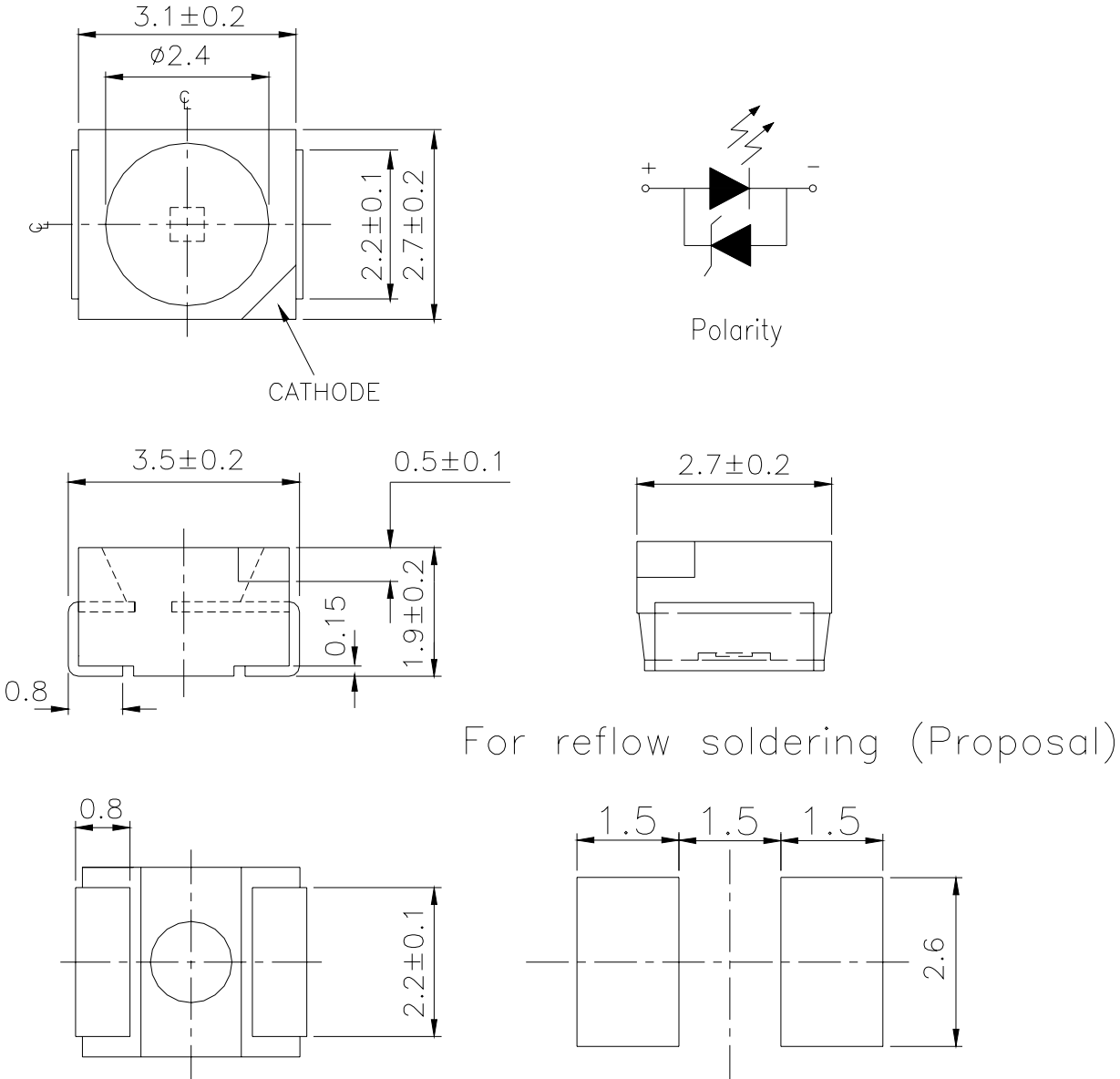

Note: The tolerances unless mentioned is ± 0.1 mm ,Unit = mm

67-11/T2C-EU2W1M/2T

Absolute Maximum Ratings (Ta=25°C)

Parameter	Symbol	Rating	Unit
Reverse Voltage	V _R	5	V
Forward Current	I _F	25	mA
Peak Forward Current (Duty 1/10 @1KHz)	I _{FP}	100	mA
Power Dissipation	P _d	110	mW
Electrostatic Discharge(HBM)	ESD	2000	V
Operating Temperature	Topr	-40 ~ +85	°C
Storage Temperature	Tstg	-40 ~ +90	°C
Soldering Temperature	Tsol	Reflow Soldering : 260 °C for 10 sec. Hand Soldering : 350 °C for 3 sec.	

Electro-Optical Characteristics (Ta=25°C)

Parameter	Symbol	Min.	Typ.	Max.	Units	Condition
Luminous Intensity	I _v	565	-----	1420	mcd	I _F =20mA
Viewing Angle	2θ _{1/2}	--	120	--	deg	I _F =20mA
Forward Voltage	V _F	2.70	-----	3.50	V	I _F =20mA

Notes:

- 1.Tolerance of Luminous Intensity ±11%
- 2.Tolerance of Forward Voltage ±0.1V

67-11/T2C-EU2W1M/2T**Bin Range Of Luminous Intensity**

Bin Code	Min.	Max.	Unit	Condition
U2	565	715	mcd	I _F =20mA
V1	715	900		
V2	900	1120		
W1	1120	1420		
W2	1420	1800		

Bin Range Of Forward Voltage

Group	Bin Code	Min.	Max.	Unit	Condition
M	5	2.75	3.05	V	I _F =20mA
	6	3.05	3.35		
	7	3.35	3.65		
	8	3.65	3.95		

Notes:

- 1.Tolerance of Luminous Intensity $\pm 11\%$
- 2.Tolerance of Forward Voltage $\pm 0.1V$

Chromaticity Coordinates Specifications for Bin Grading

($I_F=20mA$)

Group	Bin Code	CIE_x	CIE_y	Bin Code	CIE_x	CIE_y	
E	A0	0.280	0.248	B6	0.311	0.294	
		0.264	0.267		0.307	0.315	
		0.283	0.305		0.330	0.339	
		0.296	0.276		0.330	0.318	
	B3	0.287	0.295	B4	0.307	0.315	
		0.283	0.305		0.304	0.33	
		0.304	0.330		0.33	0.36	
		0.307	0.315		0.33	0.339	
	B5	0.296	0.276	/			
		0.287	0.295				
		0.307	0.315				
		0.311	0.294				

***The C.I.E. 1931 chromaticity diagram (Tolerance ± 0.01).**

CIE Chromaticity Diagram

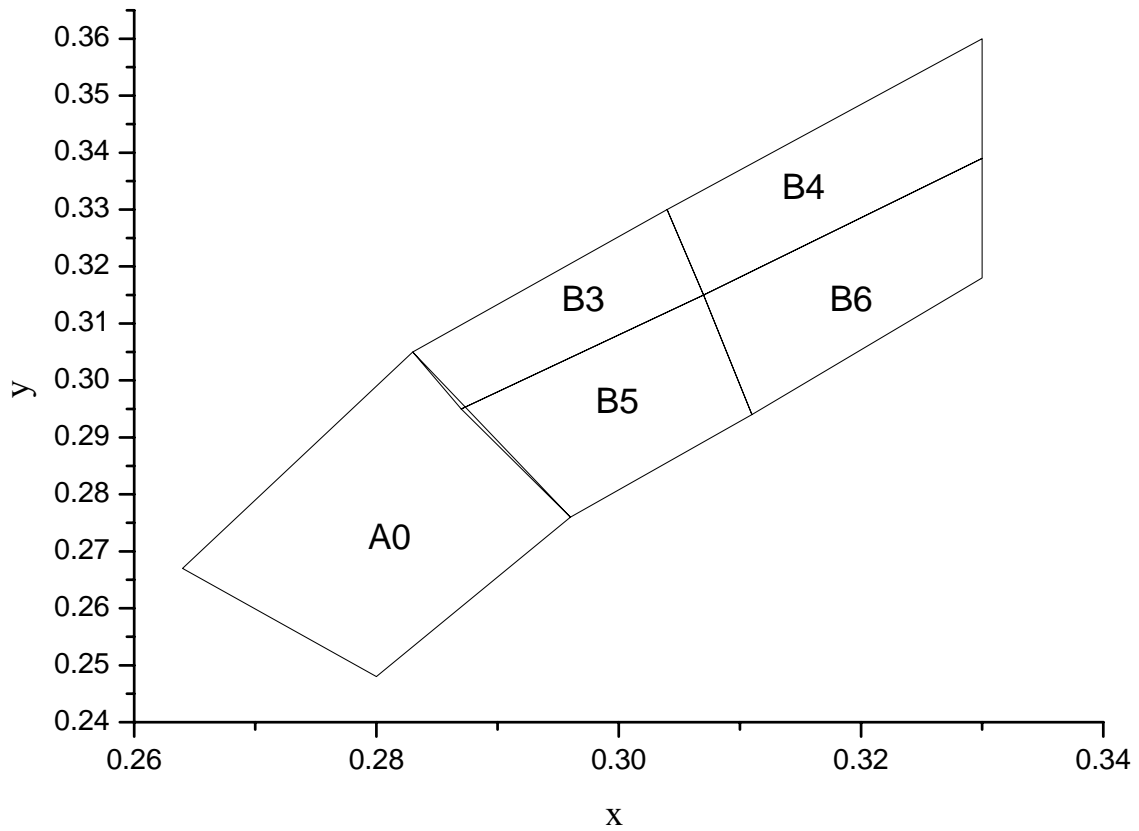

***The C.I.E. 1931 chromaticity diagram (Tolerance ± 0.01).**

67-11/T2C-EU2W1M/2T

Typical Electro-Optical Characteristics Curves

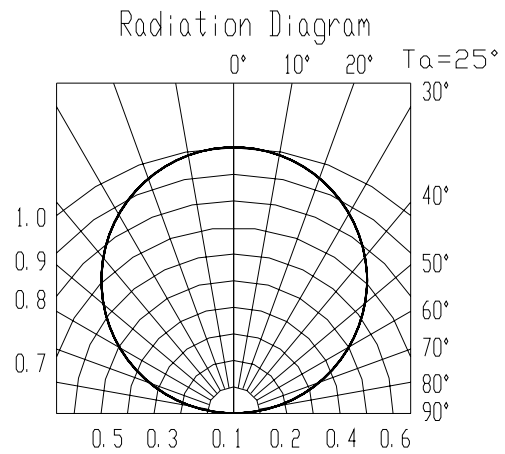
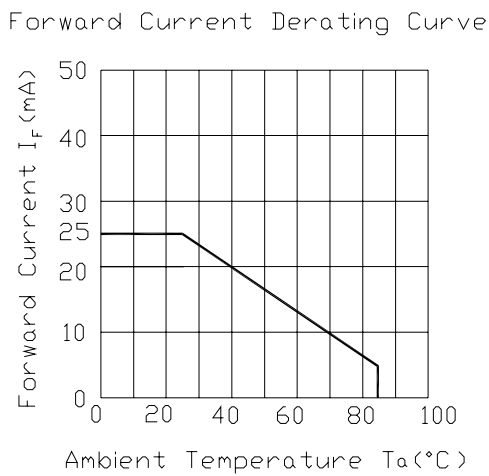
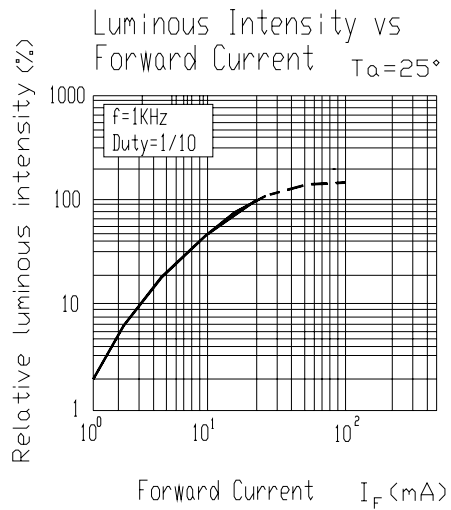
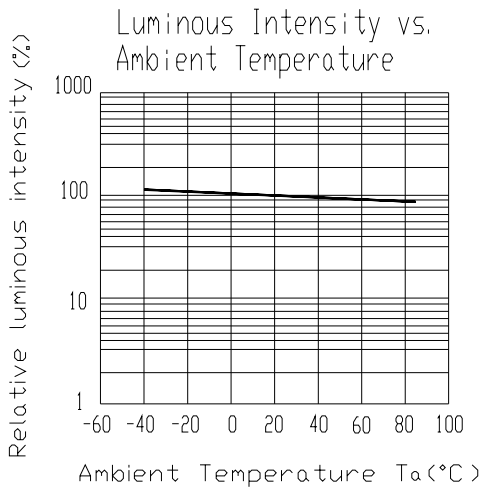
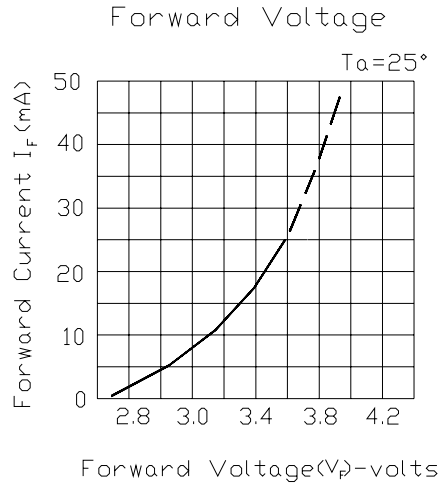
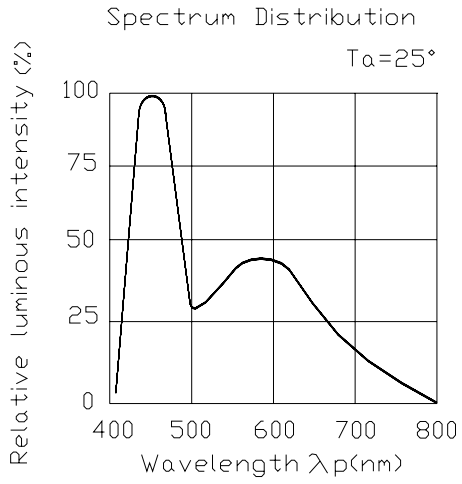

67-11/T2C-EU2W1M/2T

Label explanation

CAT: Luminous Intensity Rank

HUE: Chromaticity Coordinates

REF: Forward Voltage Rank

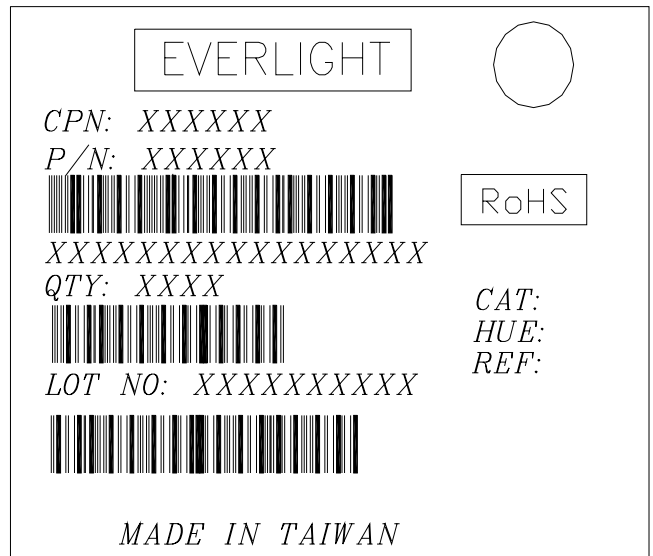

Reel Dimensions

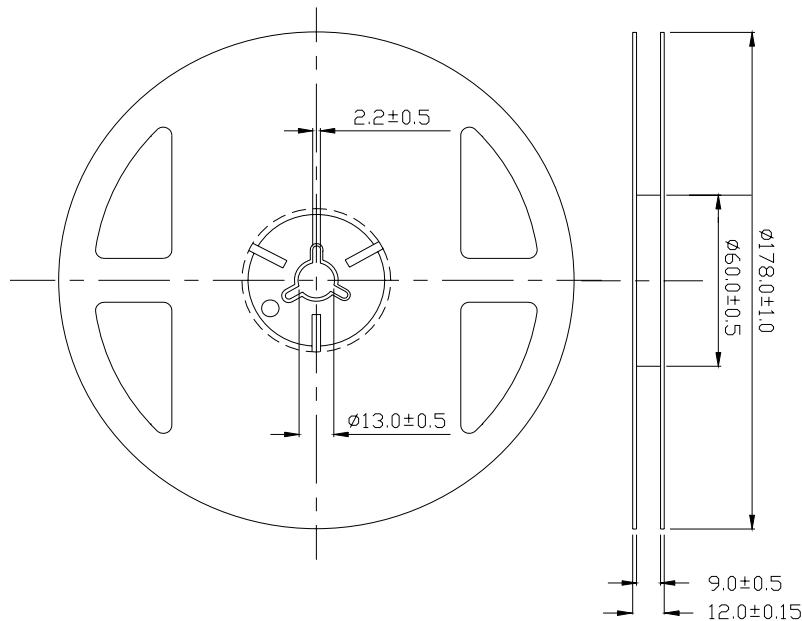

Note: The tolerances unless mentioned is ±0.1mm ,Unit = mm

Carrier Tape Dimensions: Loaded quantity 2000 PCS per reel.

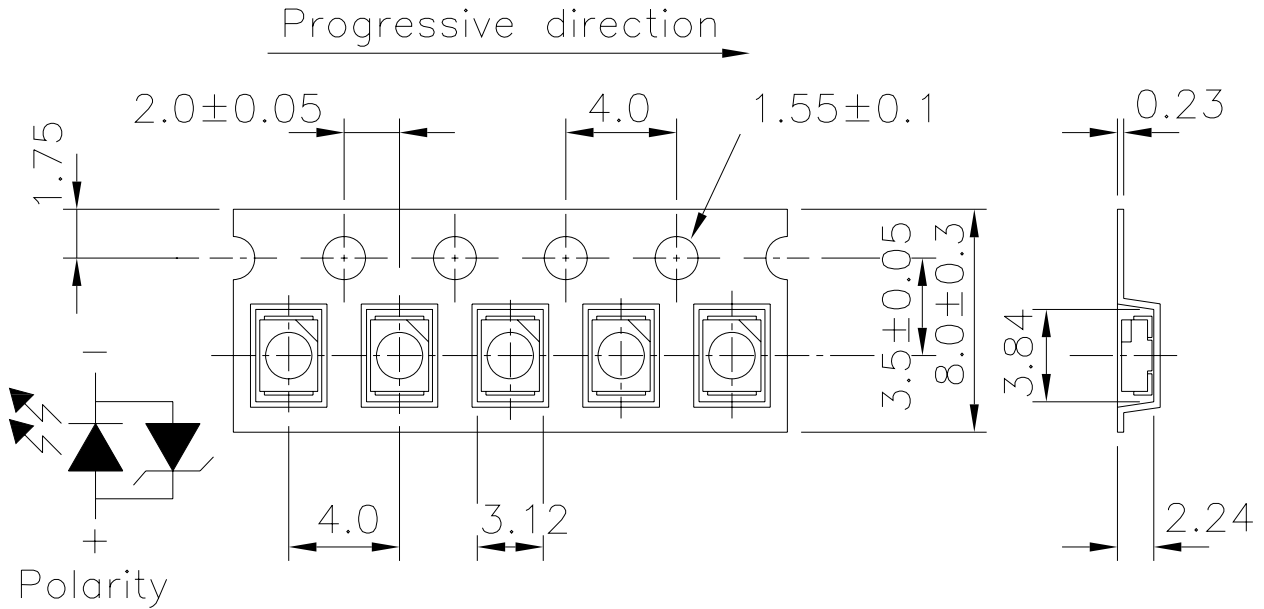

Note: The tolerances unless mentioned is ± 0.1 mm ,Unit = mm

Moisture Resistant Packaging

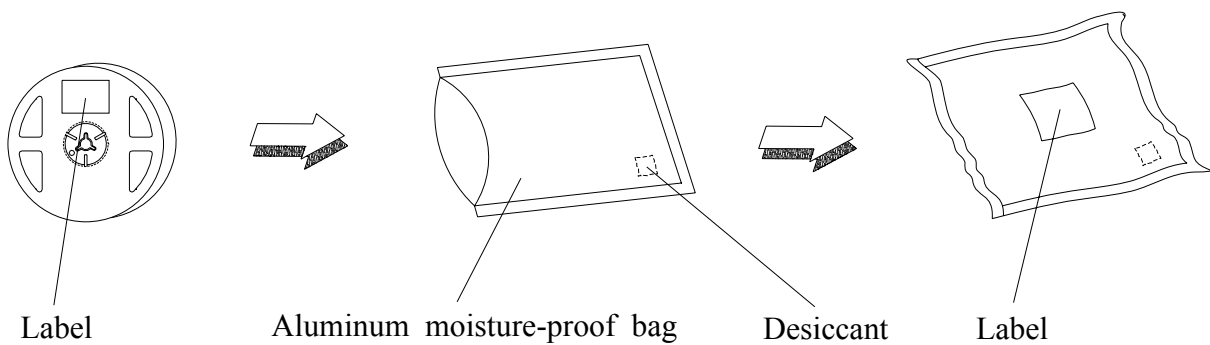

67-11/T2C-EU2W1M/2T

Reliability Test Items And Conditions

The reliability of products shall be satisfied with items listed below.

Confidence level : 90%

LTPD : 10%

No.	Items	Test Condition	Test Hours/Cycles	Sample Size	Ac/Re
1	Reflow Soldering	Temp. : 260°C±5°C Min. 5sec.	6 min	22 PCS.	0/1
2	Temperature Cycle	H : +100°C 15min ∫ 5 min L : -40°C 15min	300 Cycles	22 PCS.	0/1
3	Thermal Shock	H : +100°C 5min ∫ 10 sec L : -10°C 5min	300 Cycles	22 PCS.	0/1
4	High Temperature Storage	Temp. : 100°C	1000 Hrs.	22 PCS.	0/1
5	Low Temperature Storage	Temp. : -40°C	1000 Hrs.	22 PCS.	0/1
6	DC Operating Life	I _F = 20 mA / 25°C	1000 Hrs.	22 PCS.	0/1
7	High Temperature / High Humidity	85°C / 85%RH	1000 Hrs.	22 PCS.	0/1

Precautions For Use

1. Over-current-proof

Customer must apply resistors for protection, otherwise slight voltage shift will cause big current change (Burn out will happen).

2. Storage

- 2.1 Do not open moisture proof bag before the products are ready to use.
- 2.2 Before opening the package: The LEDs should be kept at 30°C or less and 90%RH or less.
- 2.3 After opening the package: The LED's floor life is 1 year under 30°C or less and 60% RH or less.
If unused LEDs remain, it should be stored in moisture proof packages.
- 2.4 If the moisture absorbent material (silica gel) has faded away or the LEDs have exceeded the storage time, baking treatment should be performed using the following conditions.

Baking treatment : 60±5°C for 24 hours.

3. Soldering Condition

3.1 Pb-free solder temperature profile

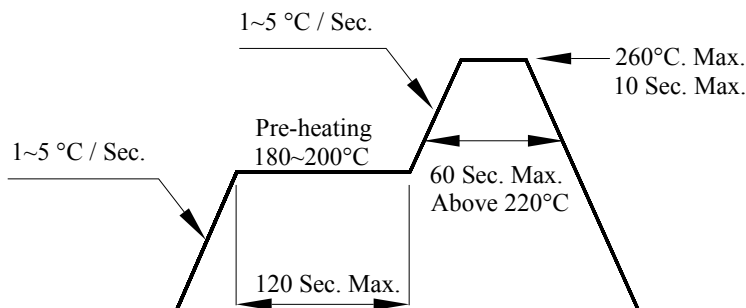

- 3.2 Reflow soldering should not be done more than two times.
- 3.3 When soldering, do not put stress on the LEDs during heating.
- 3.4 After soldering, do not warp the circuit board.

4.Soldering Iron

Each terminal is to go to the tip of soldering iron temperature less than 350°C for 3 seconds within once in less than the soldering iron capacity 25W. Leave two seconds and more intervals, and do soldering of each terminal. Be careful because the damage of the product is often started at the time of the hand solder.

5.Repairing

Repair should not be done after the LEDs have been soldered. When repairing is unavoidable, a double-head soldering iron should be used (as below figure). It should be confirmed beforehand whether the characteristics of the LEDs will or will not be damaged by repairing.

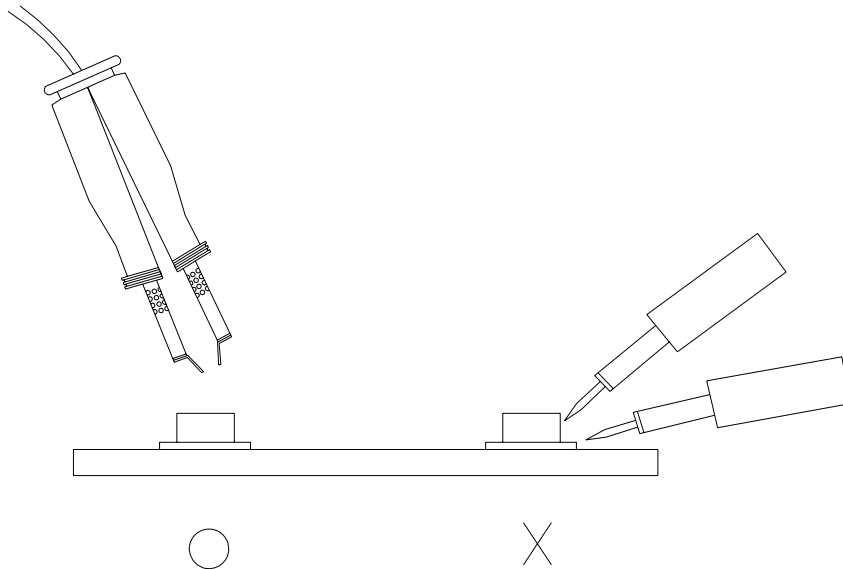

EVERLIGHT ELECTRONICS CO., LTD.

Office: No 25, Lane 76, Sec 3, Chung Yang Rd,
Tucheng, Taipei 236, Taiwan, R.O.C

Tel: 886-2-2267-2000, 2267-9936

Fax: 886-2267-6244, 2267-6189, 2267-6306

<http://www.everlight.com>