

Technical Data Sheet

Mini Top View LEDs

65-21-R7C-A6Q2S1B0E-2T8-AM

Lead (Pb) Free Product - RoHS Compliant



Feature

- RoHS compliant.
- Mini P-LCC-2 package.
- Colorless clear resin.
- Wide viewing angle 120°.
- Inner reflector and white package.
- Brightness: 90 to 224mcd at 20mA.
- Qualification according to AEC-Q101 rev C.
- Precondition: Bases on JEDEC J-STD 020D Level 2.
- Automotive reflow profile (IR reflow or wave soldering).

Applications

- Automotive backlighting or indicator: Dashboard, switch, audio and video equipments...etc.
- Backlight: LCD, switches, symbol, mobile phone and illuminated advertising.
- Display for indoor and outdoor application.
- Ideal for coupling into light guides.
- Substitution of traditional light.
- Optical indicator.
- General applications.

Device Selection Guide

Chip	Emitted Color	Resin Color
Material		
AlGaInP	Dark - Red	Water Clear

Technical Data Sheet

Mini Top View LEDs

65-21-R7C-A6Q2S1B0E-2T8-AM

Absolute Maximum Ratings (Ta=25°C)

Parameter	Symbol	Rating	Unit
Reverse Voltage	V _R	10	V
Forward Current	I _F	25	mA
Peak Forward Current (Duty 1/10 @1KHz)	I _{FP}	60	mA
Power Dissipation	P _d	60	mW
Junction Temperature	T _j	115	°C
Operating Temperature	T _{opr}	-40 ~ +100	°C
Storage Temperature	T _{stg}	-40 ~ +110	°C
Thermal Resistance	R _{th J-A}	500	K/W
	R _{th J-S}	300	K/W
ESD (Classification acc. AEC Q101)	ESD _{HBM}	2000	V
	ESD _{MM}	200	V
Soldering Temperature	T _{sol}	Reflow Soldering : 260 °C for 30 sec. Hand Soldering : 350 °C for 3 sec.	

Technical Data Sheet
Mini Top View LEDs
65-21-R7C-A6Q2S1B0E-2T8-AM
Electro-Optical Characteristics (Ta=25°C)

Parameter	Symbol	Min.	Typ.	Max.	Unit	Condition
Luminous Intensity	I_v	90	---	224	mcd	$I_F = 20\text{mA}$
Viewing Angle	$2\theta_{1/2}$	---	120	---	deg	$I_F = 20\text{mA}$
Peak Wavelength	λ_p	---	639	---	nm	$I_F = 20\text{mA}$
Dominant Wavelength	λ_d	627	---	639	nm	$I_F = 20\text{mA}$
Spectrum Radiation Bandwidth	$\Delta\lambda$	---	20	---	nm	$I_F = 20\text{mA}$
Forward Voltage	V_F	1.75	---	2.35	V	$I_F = 20\text{mA}$
Reverse Current	I_R	---	---	10	μA	$V_R = 12\text{V}$
Temperature coefficient of λ_p	TC_{λ_p}	---	0.11	---	nm/K	$I_F = 20\text{mA}$
Temperature coefficient of λ_d	TC_{λ_d}	---	0.04	---	nm/K	$I_F = 20\text{mA}$
Temperature coefficient of V_F	TC_V	---	-1.7	---	mV/K	$I_F = 20\text{mA}$

Note:

1. Tolerance of Luminous Intensity: $\pm 11\%$
2. Tolerance of Dominant Wavelength: $\pm 1\text{nm}$
3. Tolerance of Forward Voltage: $\pm 0.1\text{V}$

Technical Data Sheet

Mini Top View LEDs

65-21-R7C-A6Q2S1B0E-2T8-AM

Bin Range of Luminous Intensity

Bin Code	Min.	Max.	Unit	Condition
Q2	90	112	mcd	I _F =20mA
R1	112	140		
R2	140	180		
S1	180	224		

Note:

Tolerance of Luminous Intensity: ±11%

Bin Range of Dominant Wavelength

Bin Code	Min.	Max.	Unit	Condition
1	627	630	nm	I _F =20mA
2	630	633		
3	633	636		
4	636	639		

Note:

Tolerance of Dominant Wavelength : ±1nm

Technical Data Sheet

Mini Top View LEDs

65-21-R7C-A6Q2S1B0E-2T8-AM

Typical Electro-Optical Characteristics Curves

Typical Curve of Spectral Distribution

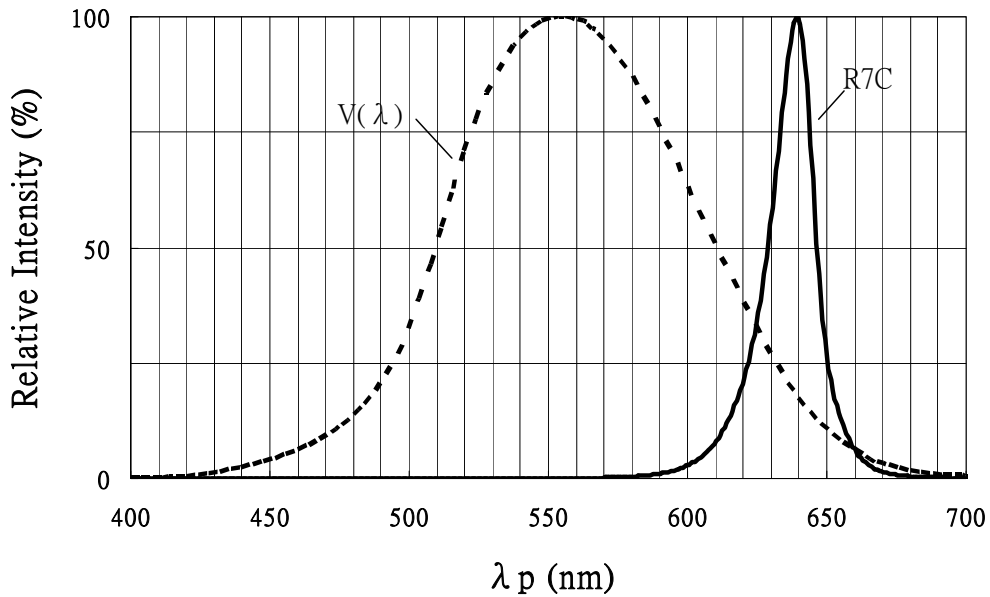

Note: $V(\lambda)$ =Standard eye response curve

Diagram Characteristics of Radiation

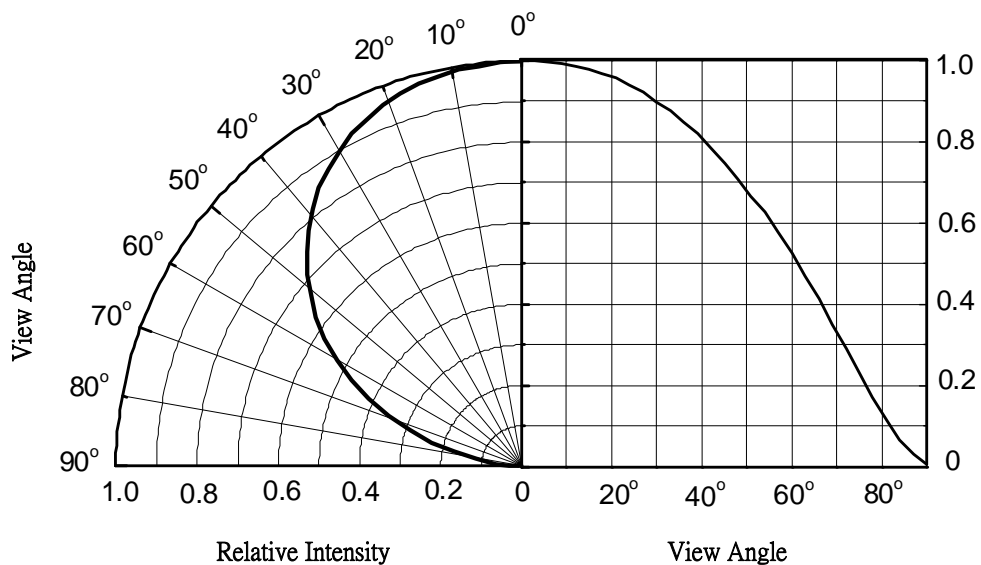

Technical Data Sheet

Mini Top View LEDs

65-21-R7C-A6Q2S1B0E-2T8-AM

Forward Current vs. Forward Voltage (Ta=25°C)

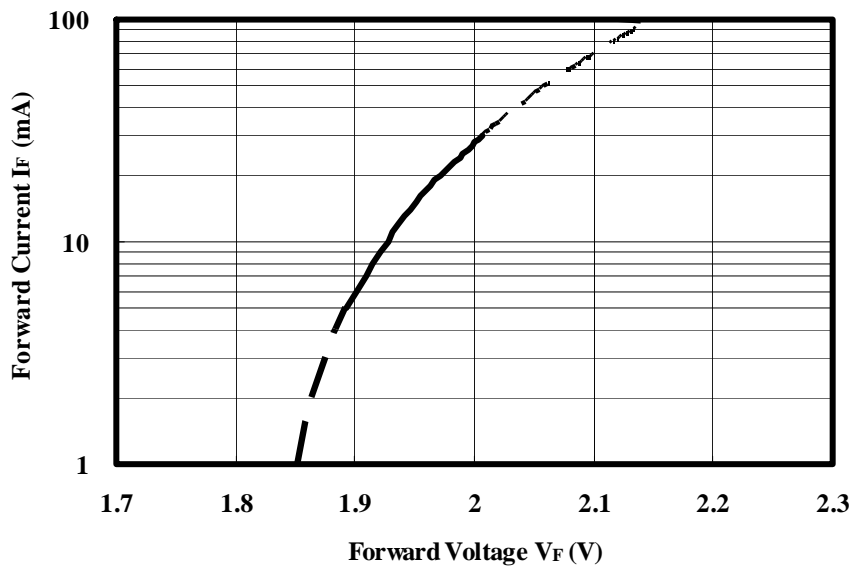

Forward Current vs. Relative Luminous Intensity (Ta=25°C)

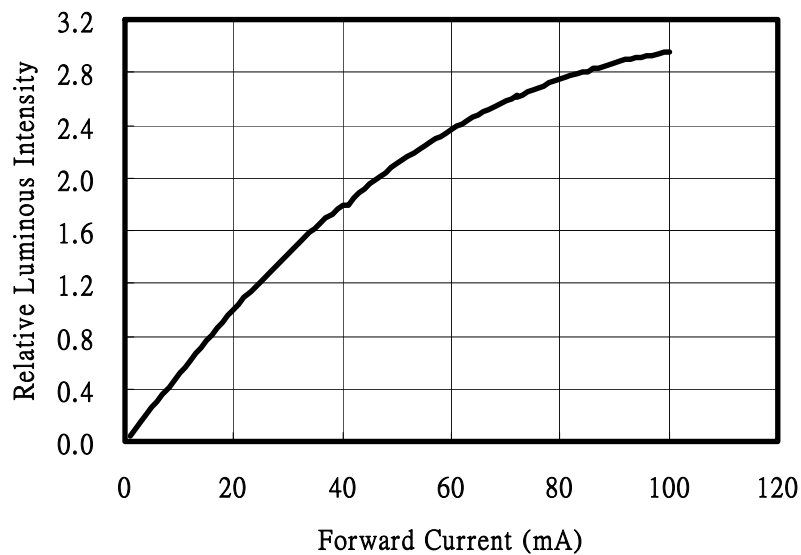

Technical Data Sheet

Mini Top View LEDs

65-21-R7C-A6Q2S1B0E-2T8-AM

Forward current vs. Ambient and Solder Temperature

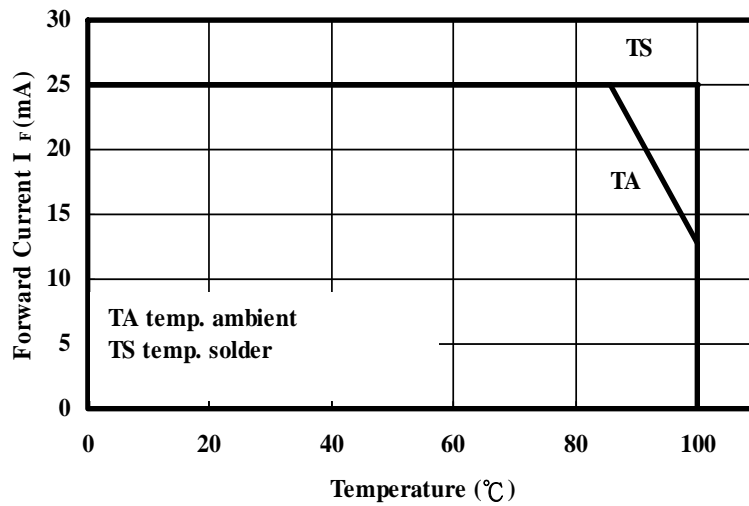

Relative Luminous Intensity vs. Junction Temperature

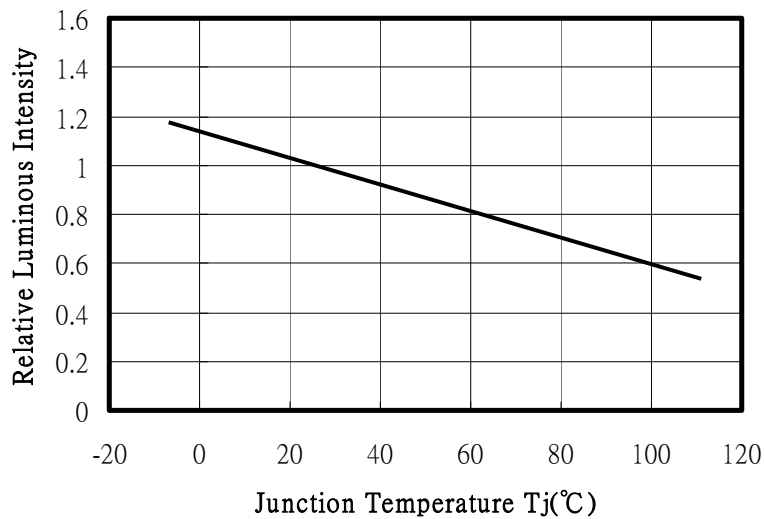

Note: $f(T_j) = I_v / I_v(25^\circ\text{C})$; $I_F = 20\text{mA}$

Technical Data Sheet

Mini Top View LEDs

65-21-R7C-A6Q2S1B0E-2T8-AM

Relative Forward Voltage vs. Junction Temperature

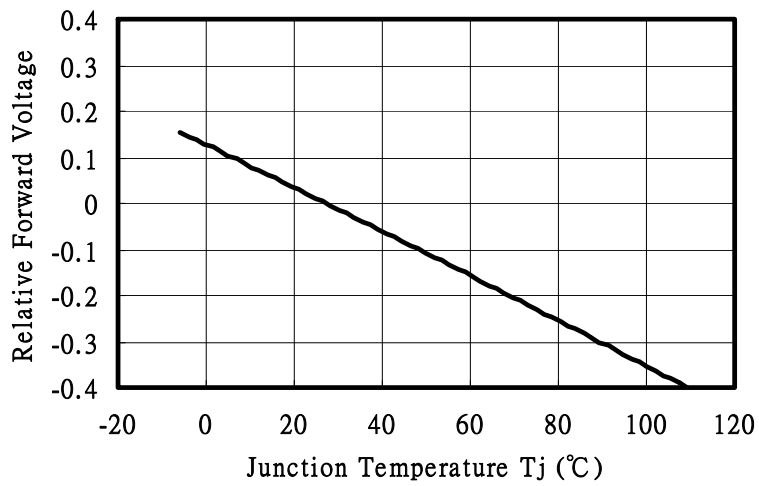

Note: $\Delta V_F = V_F - V_F(25\text{ }^\circ\text{C}) = f(T_j)$; $I_F = 20\text{mA}$

Technical Data Sheet

Mini Top View LEDs

65-21-R7C-A6Q2S1B0E-2T8-AM

Package Dimension

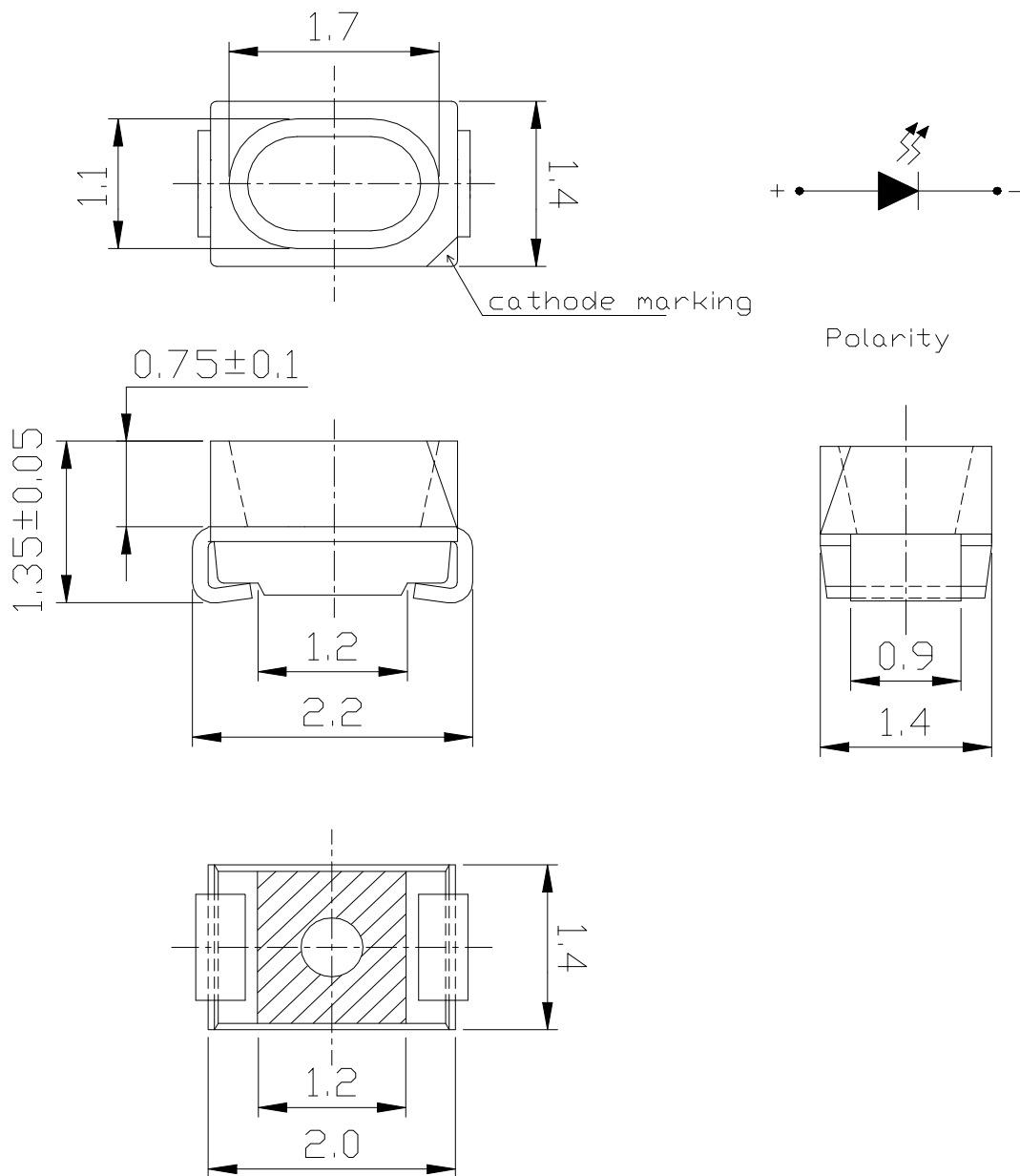

Note: Tolerances unless mentioned ±0.1mm. Unit = mm

Technical Data Sheet

Mini Top View LEDs

65-21-R7C-A6Q2S1B0E-2T8-AM

Moisture Resistant Packing Materials

Label Explanation

- CPN: Customer's Product Number
- P/N: Product Number
- QTY: Packing Quantity
- CAT: Luminous Intensity Rank
- HUE: Dom. Wavelength Rank
- REF: Forward Voltage Rank
- LOT No: Lot Number



Reel Dimensions

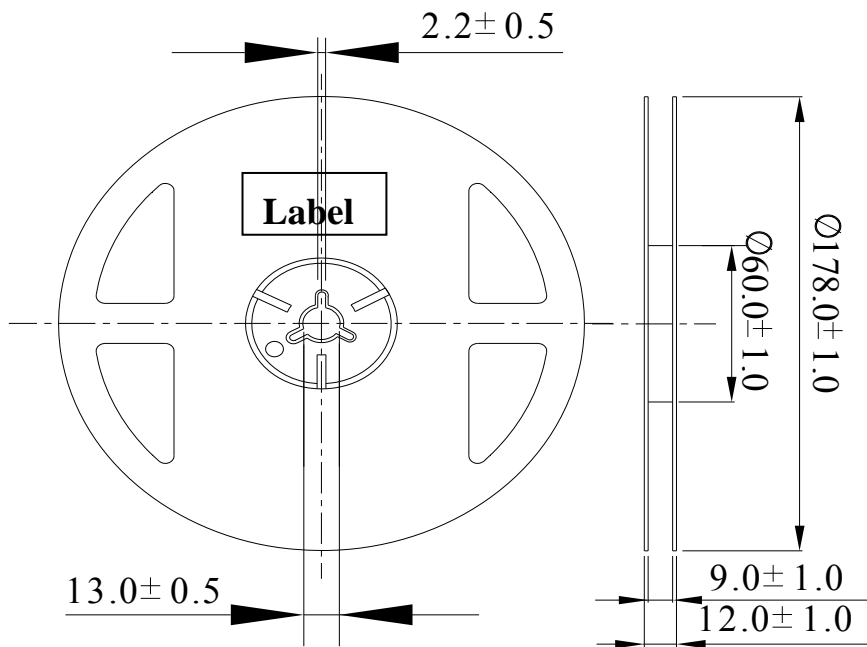

Note: Unit = mm

Technical Data Sheet

Mini Top View LEDs

65-21-R7C-A6Q2S1B0E-2T8-AM

Carrier Tape Dimensions: Loaded Quantity 2000 pcs Per Reel

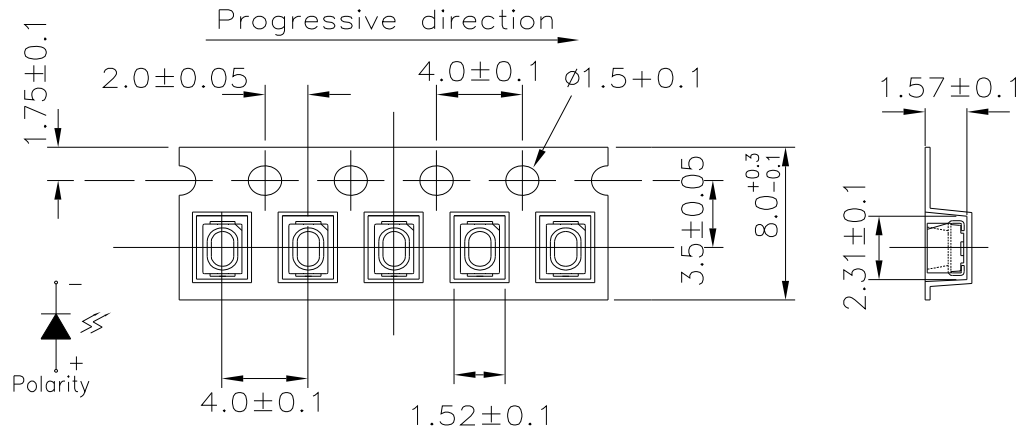

Note: Tolerances unless mentioned ± 0.1 mm. Unit = mm

Moisture Resistant Packing Process

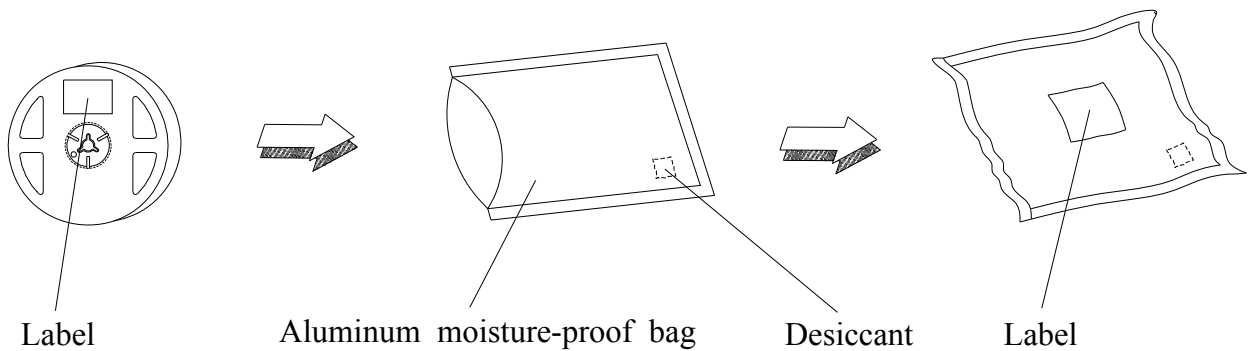

Technical Data Sheet

Mini Top View LEDs

65-21-R7C-A6Q2S1B0E-2T8-AM

Precautions for Use

1. Soldering Condition

1.1 (A) Maximum Body Case Temperature Profile for evaluation of Reflow Profile

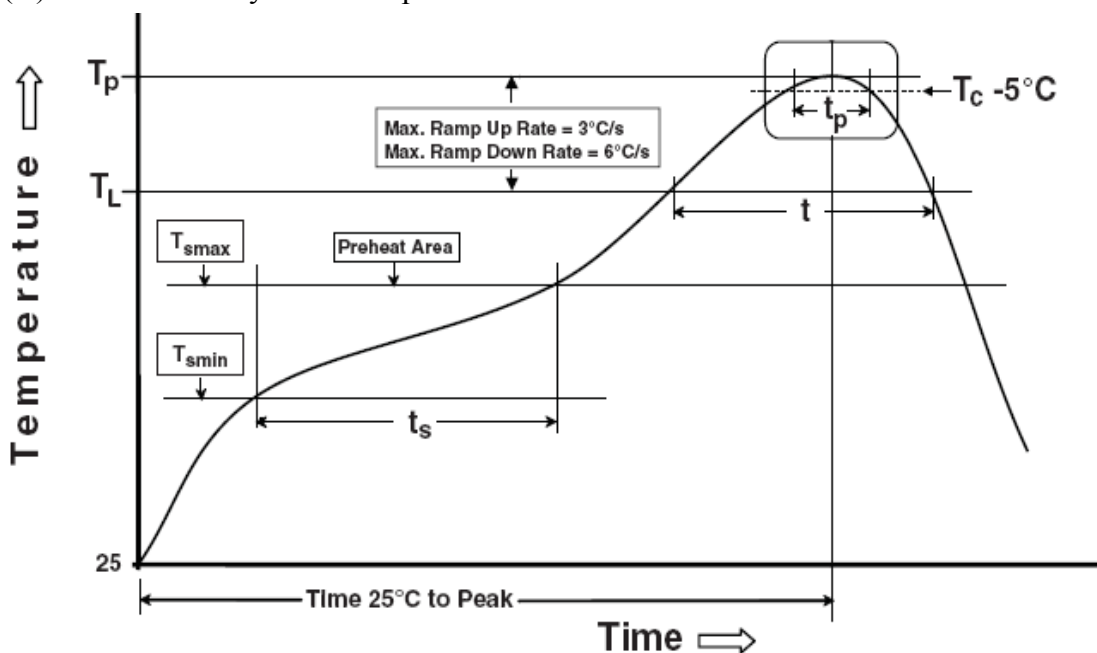

Note:

Preheat

Temperature min (T_{smin})

Temperature max (T_{smax})

Time (T_{smin} to T_{smax}) (t_s)

Average ramp-up rate (T_{smax} to T_p)

Other

Liquidus Temperature (T_L)

Time above Liquidus Temperature (t_L)

Peak Temperature (T_p)

Time within 5 °C of Actual Peak Temperature: $T_p - 5^\circ\text{C}$

Ramp- Down Rate from Peak Temperature

Time 25°C to peak temperature

Reflow times

Reference: IPC/JEDEC J-STD-020D

150 °C

200°C

60-120 seconds

3 °C/second max

217 °C

60-150 sec

260°C

30 s

6°C /second max.

8 minutes max.

3 times

All parameters are maximum body case temperature values and cannot be considered as a soldering profile. The body case temperature was measured by soldering a thermal couple to the soldering point of LEDs.

Technical Data Sheet**Mini Top View LEDs****65-21-R7C-A6Q2S1B0E-2T8-AM**

(B) Recommend soldering pad

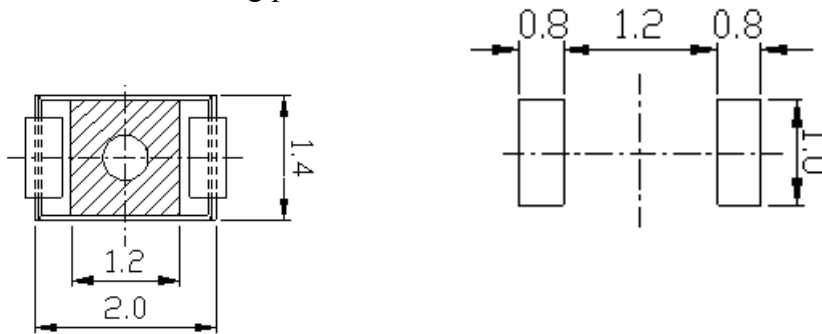

Note: Tolerances unless mentioned ± 0.1 mm. Unit = mm

2. Current limiting

A resistor should be used to limit current spikes that can be caused by voltage fluctuations. Otherwise damage could occur.

3. Storage

- 3.1 Moisture proof bag should only be opened immediately prior to usage.
- 3.2 Environment should be less than 30°C and 60% RH when moisture proof bag is opened.
- 3.3 After opening the package MSL Conditions stated on page 1 of this spec should not be exceeded.
- 3.4 If the moisture sensitivity card indicates higher than acceptable moisture, the component should be baked at min. 60deg +/-5deg for 24 hours.

4. Iron Soldering

Hand soldering is not recommended for regular production. These guidelines are for rework only. Soldering iron tip should contact each terminal no more than 3 sec at 350°C, using soldering iron with nominal power less than 25W. Allow min. 2 sec. between soldering intervals.

5. Usage

Do not exceed the values given in this specification.

Application Restrictions

High reliability applications such as military/aerospace, automotive safety/security systems, and medical equipment may require different product. If you have any concerns, please contact Everlight before using this product in your application. This specification guarantees the quality and performance of the product as an individual component. Do not use this product beyond the specification described in this document.