

Technical Data Sheet**White SMD Surface Mount Device**

65-11/Y1P-S1T2GY/2T**Features**

- White SMT package.
- Optical indicator.
- Wide viewing angle.
- Soldering methods: reflow soldering
- Available on tape and reel
- Pb-free.
- The product itself will remain within RoHS compliant version.

**Descriptions**

- The 65-11 series is available in soft orange, green, blue, and yellow. Due to the package design, the LED has wide viewing angle and optimized light coupling by inter reflector. This feature makes the LED ideal for light pipe application.

Applications

- Optical indicators.
- Coupling into light guides.
- Backlighting (LCD, cellular phones, switches, keys, displays, illuminated advertising, general lighting).
- Coupling into light guides.

Device Selection Guide

Chip	Emitted Color	Resin Color
Material		
GaAsP/GaP	Yellow	Water Clear

Technical Data Sheet

White SMD Surface Mount Device

65-11/Y1P-S1T2GY/2T

Package Dimensions

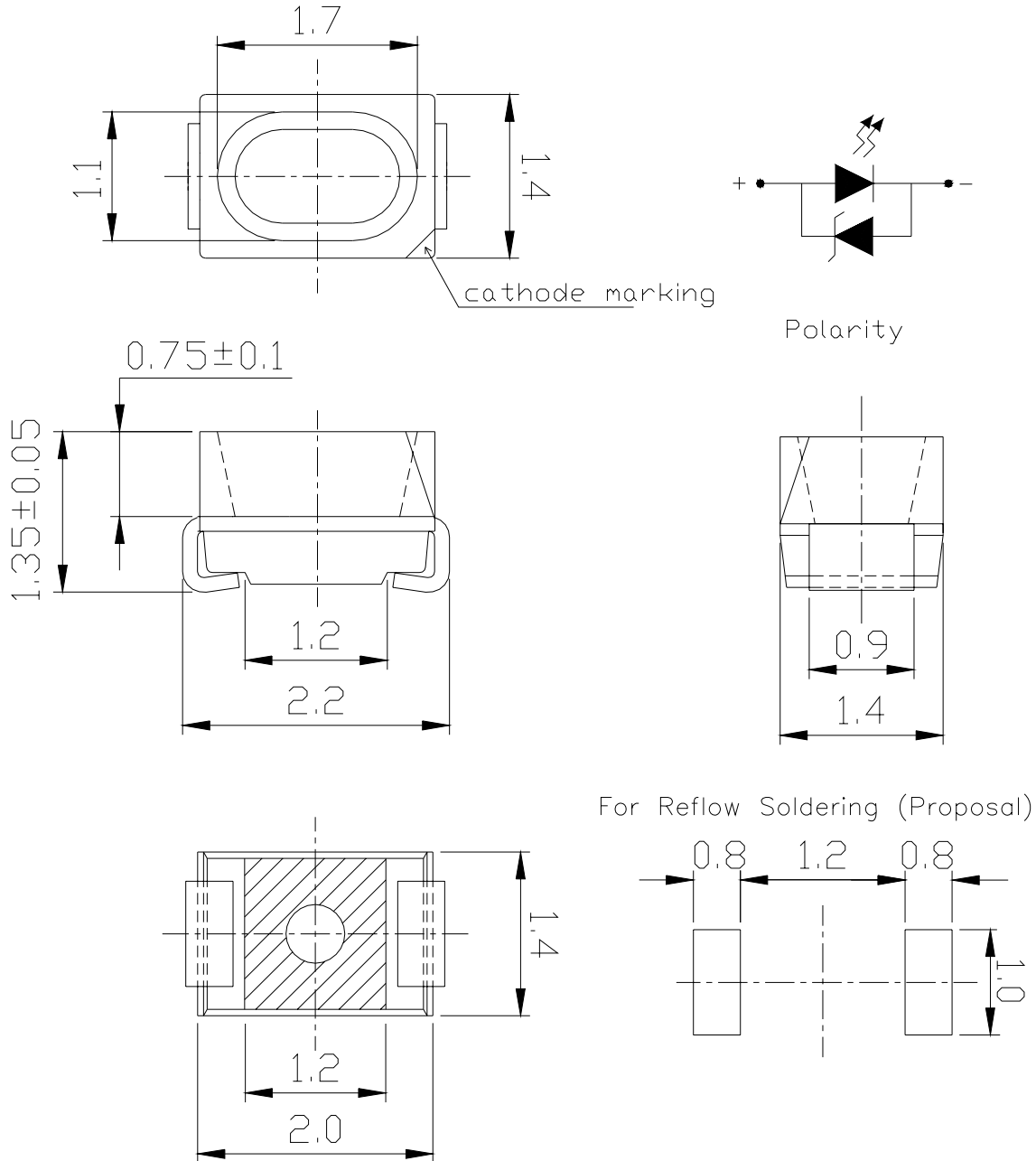

Note: The tolerances unless mentioned is ±0.1mm ,Unit = mm

**Technical Data Sheet****White SMD Surface Mount Device****65-11/Y1P-S1T2GY/2T****Absolute Maximum Ratings (Ta=25°C)**

Parameter	Symbol	Rating	Unit
Reverse Voltage	V _R	5	V
Forward Current	I _F	25	mA
Operating Temperature	Topr	-40 ~ +85	°C
Storage Temperature	Tstg	-40 ~ +90	°C
Electrostatic Discharge(HBM)	ESD	2000	V
Power Dissipation	Pd	110	mW
Peak Forward Current (Duty 1/10 @1KHz)	I _{FP}	100	mA
Soldering Temperature	Tsol	Reflow Soldering : 260 °C for 10 sec. Hand Soldering : 350 °C for 3 sec.	

Electro-Optical Characteristics (Ta=25°C)

Parameter	Symbol	Min.	Typ.	Max.	Units	Condition
Luminous Intensity	I _v	180	-----	450	mcd	I _F =5mA
Viewing Angle	2θ 1/2	--	120	--	deg	I _F =5mA
Forward Voltage	V _F	2.70	-----	3.70	V	I _F =5mA

Notes:

- 1.Tolerance of Luminous Intensity ±10%
- 2.Tolerance of Forward Voltage ±0.1V



Technical Data Sheet

White SMD Surface Mount Device

65-11/Y1P-S1T2GY/2T

Bin Range of Luminous Intensity

Bin Code	Min.	Max.	Unit	Condition
S1	180	225	mcd	I _F =5mA
S2	225	280		
T1	280	360		
T2	360	450		

Bin Range of Forward Voltage

Group	Bin	Min.	Max.	Unit	Condition
G	34	2.70	2.80	V	I _F =5mA
	35	2.80	2.90		
	36	2.90	3.00		
	37	3.00	3.10		
	38	3.10	3.20		
	39	3.20	3.30		
	40	3.30	3.40		
	41	3.40	3.50		
	42	3.50	3.60		
	43	3.60	3.70		

Notes:

- 1.Tolerance of Luminous Intensity $\pm 10\%$
- 2.Tolerance of Forward Voltage $\pm 0.1V$

Technical Data Sheet

White SMD Surface Mount Device

65-11/Y1P-S1T2GY/2T

Bin Range of Chromaticity Coordinates

Bin Code	CIE_u'	CIE_v'	Bin Code	CIE_u'	CIE_v'	Condition
D0-1	0.1890	0.5160	D0-2	0.1934	0.5229	I _F =5mA
	0.1934	0.5229		0.1978	0.5298	
	0.2000	0.5130		0.2044	0.5199	
	0.1955	0.5061		0.2000	0.5130	
D0-3	0.1955	0.5061	D0-4	0.2000	0.5130	
	0.2000	0.5130		0.2044	0.5199	
	0.2065	0.5031		0.2110	0.5100	
	0.2021	0.4962		0.2065	0.5031	

Note:Tolerance of Chromaticity Coordinates: ±0.01

The C.I.E. 1931 chromaticity diagram.

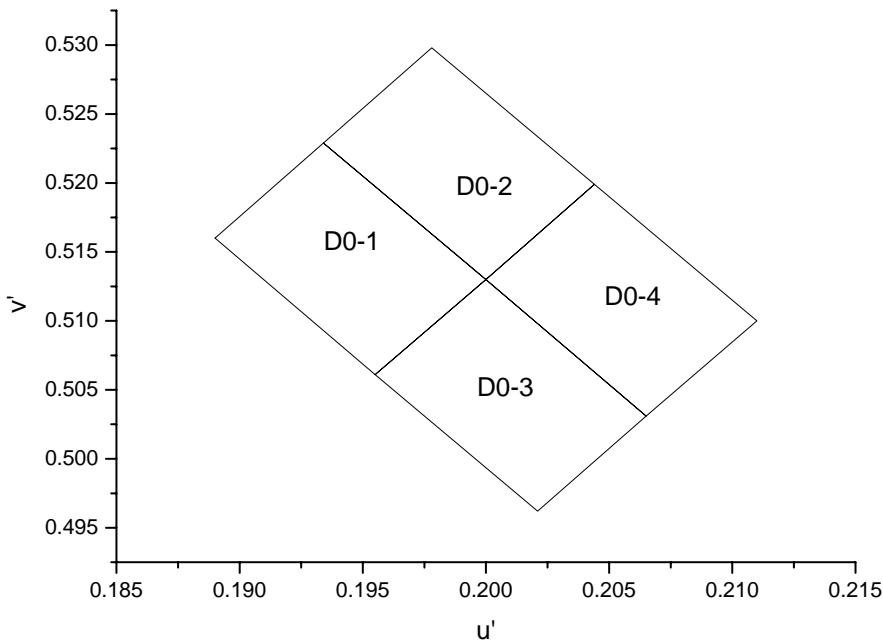

Technical Data Sheet

White SMD Surface Mount Device

65-11/Y1P-S1T2GY/2T

Typical Electro-Optical Characteristics Curves

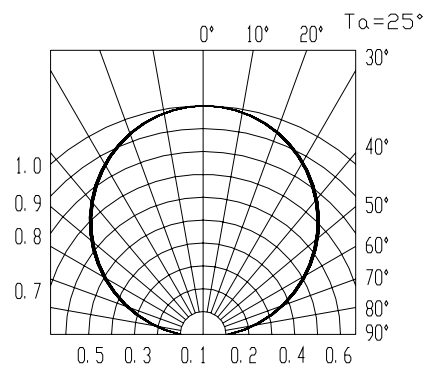
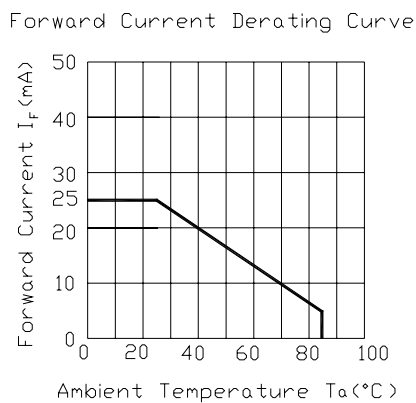
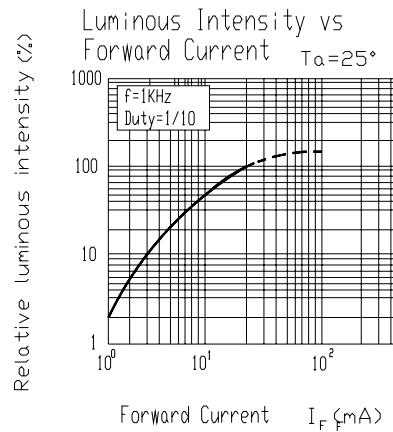
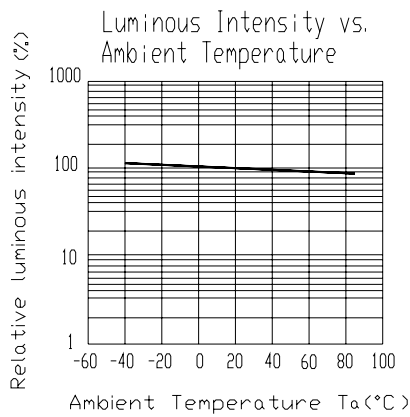
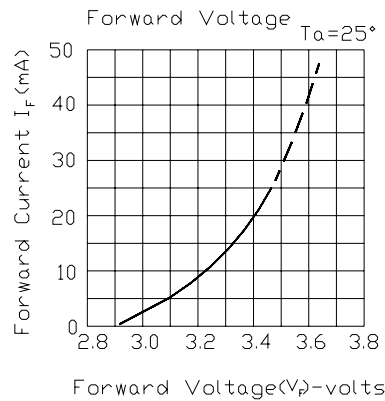
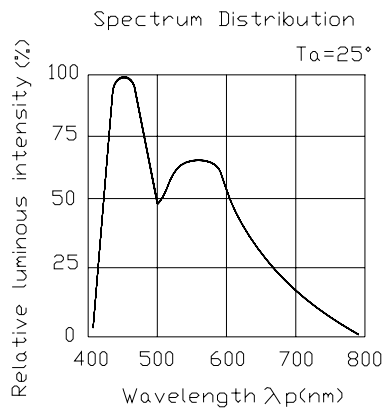

Technical Data Sheet

White SMD Surface Mount Device

65-11/Y1P-S1T2GY/2T

Label Explanation

- CAT: Luminous Intensity Rank
- HUE: Chromaticity Coordinates
- REF: Forward Voltage Rank

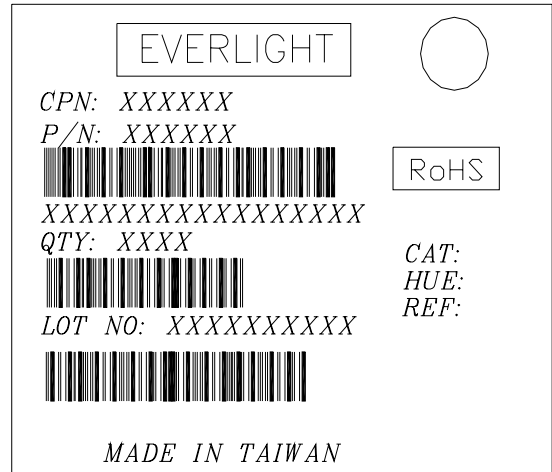

Reel Dimensions

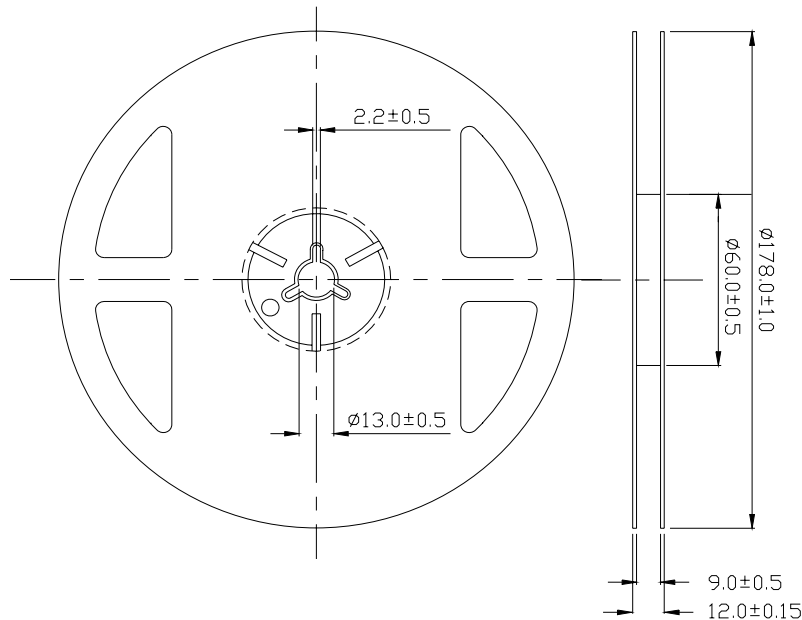

Note: The tolerances unless mentioned is ±0.1mm ,Unit = mm

Technical Data Sheet

White SMD Surface Mount Device

65-11/Y1P-S1T2GY/2T

Carrier Tape Dimensions: Loaded Quantity 2000 pcs Per Reel.

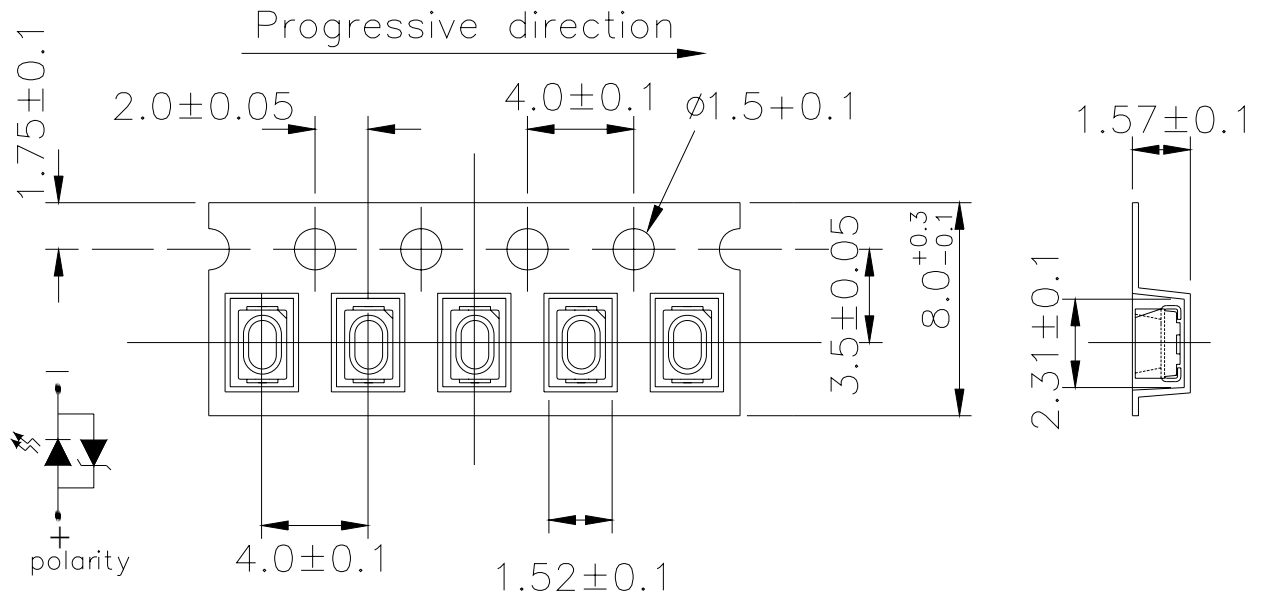

Note: The tolerances unless mentioned is ±0.1mm ,Unit = mm

Moisture Resistant Packaging

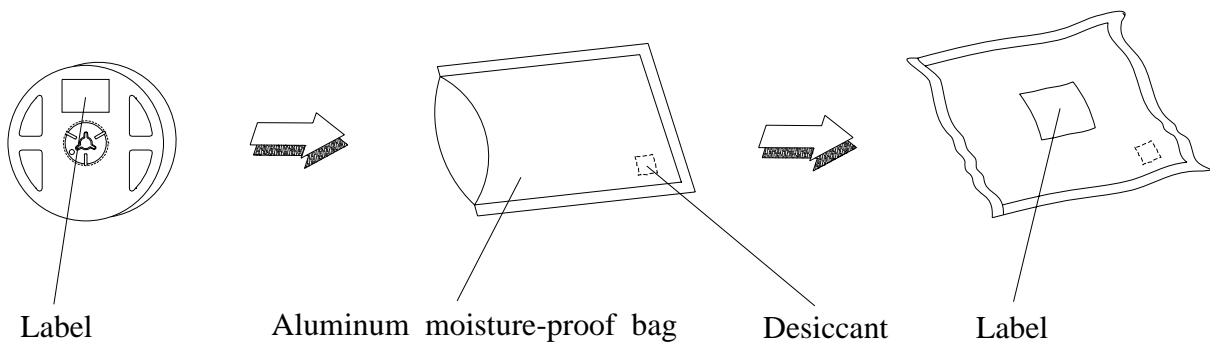



Technical Data Sheet

White SMD Surface Mount Device

65-11/Y1P-S1T2GY/2T

Reliability Test Items And Conditions

The reliability of products shall be satisfied with items listed below.

Confidence level : 90%

LTPD : 10%

No.	Items	Test Condition	Test Hours/Cycles	Sample Size	Ac/Re
1	Reflow Soldering	Temp. : 260°C±5°C Min. 5sec.	6 min	22 PCS.	0/1
2	Temperature Cycle	H : +100°C 15min ∫ 5 min L : -40°C 15min	300 Cycles	22 PCS.	0/1
3	Thermal Shock	H : +100°C 5min ∫ 10 sec L : -10°C 5min	300 Cycles	22 PCS.	0/1
4	High Temperature Storage	Temp. : 100°C	1000 Hrs.	22 PCS.	0/1
5	Low Temperature Storage	Temp. : -40°C	1000 Hrs.	22 PCS.	0/1
6	DC Operating Life	IF = 5 mA / 25°C	1000 Hrs.	22 PCS.	0/1
7	High Temperature / High Humidity	85°C/ 85%RH	1000 Hrs.	22 PCS.	0/1

Technical Data Sheet**White SMD Surface Mount Device****65-11/Y1P-S1T2GY/2T****Precautions For Use****1. Over-current-proof**

Customer must apply resistors for protection, otherwise slight voltage shift will cause big current change (Burn out will happen).

2. Storage

2.1 Do not open moisture proof bag before the products are ready to use.

2.2 Before opening the package: The LEDs should be kept at 30°C or less and 90%RH or less.

2.3 After opening the package: The LED's floor life is 1 year under 30°C or less and 60% RH or less.

If unused LEDs remain, it should be stored in moisture proof packages.

2.4 If the moisture absorbent material (silica gel) has faded away or the LEDs have exceeded the storage time, baking treatment should be performed using the following conditions.

Baking treatment : 60±5°C for 24 hours.

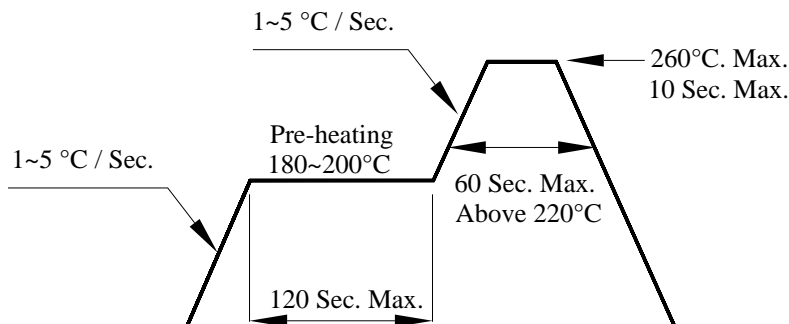
3. Soldering Condition**3.1 Pb-free solder temperature profile**

3.2 Reflow soldering should not be done more than two times.

3.3 When soldering, do not put stress on the LEDs during heating.

3.4 After soldering, do not warp the circuit board.

4. Soldering Iron

Each terminal is to go to the tip of soldering iron temperature less than 350°C for 3 seconds within once in less than the soldering iron capacity 25W. Leave two seconds and more intervals, and do soldering of each terminal. Be careful because the damage of the product is often started at the time of the hand solder.

Technical Data Sheet**White SMD Surface Mount Device****65-11/Y1P-S1T2GY/2T****5. Repairing**

Repair should not be done after the LEDs have been soldered. When repairing is unavoidable, a double-head soldering iron should be used (as below figure). It should be confirmed beforehand whether the characteristics of the LEDs will or will not be damaged by repairing.

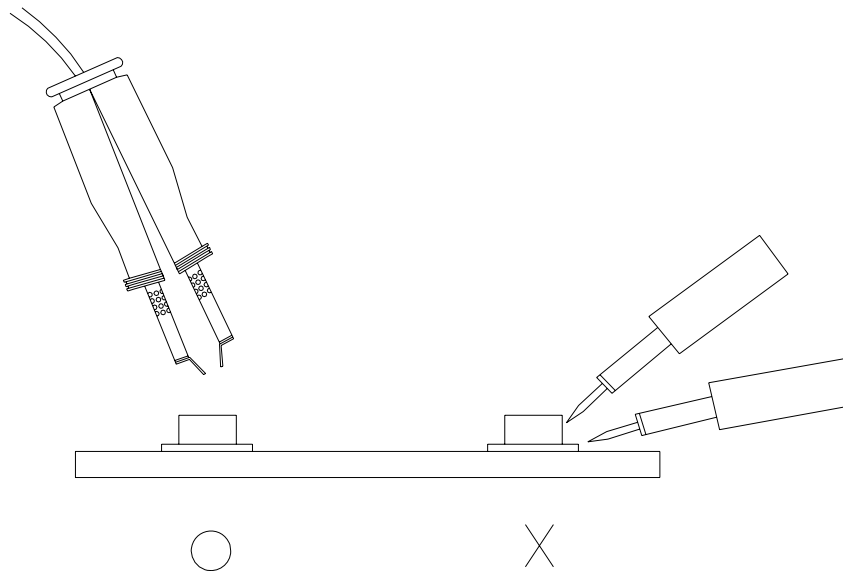

EVERLIGHT ELECTRONICS CO., LTD.
Office: No 25, Lane 76, Sec 3, Chung Yang Rd,
Tucheng, Taipei 236, Taiwan, R.O.C

Tel: 886-2-2267-2000, 2267-9936
Fax: 886-2267-6244, 2267-6189, 2267-6306
<http://www.everlight.com>