

Technical Data Sheet**Mini TOP Views LEDs****65-11UTC/S933/TR8****Features**

- White SMT package.
- Optical indicator.
- Wide viewing angle.
- Soldering methods: IR reflow soldering.
- Available on tape and reel.
- Pb-free
- The product itself will remain within RoHS compliant version.

**Descriptions**

- The 65-11 series is available in soft orange, green, blue, and yellow. Due to the package design, the LED has wide viewing angle and optimized light coupling by inter reflector. This feature makes the LED ideal for light pipe application.

Applications

- Optical indicators.
- Coupling into light guides.
- Backlighting (LCD, cellular phones, switches, keys, displays, illuminated advertising, general lighting).
- Coupling into light guides.

Device Selection Guide

Chip	Emitted Color	Resin Color
Material		
InGaN	Pure White	Water Clear

Package Dimensions

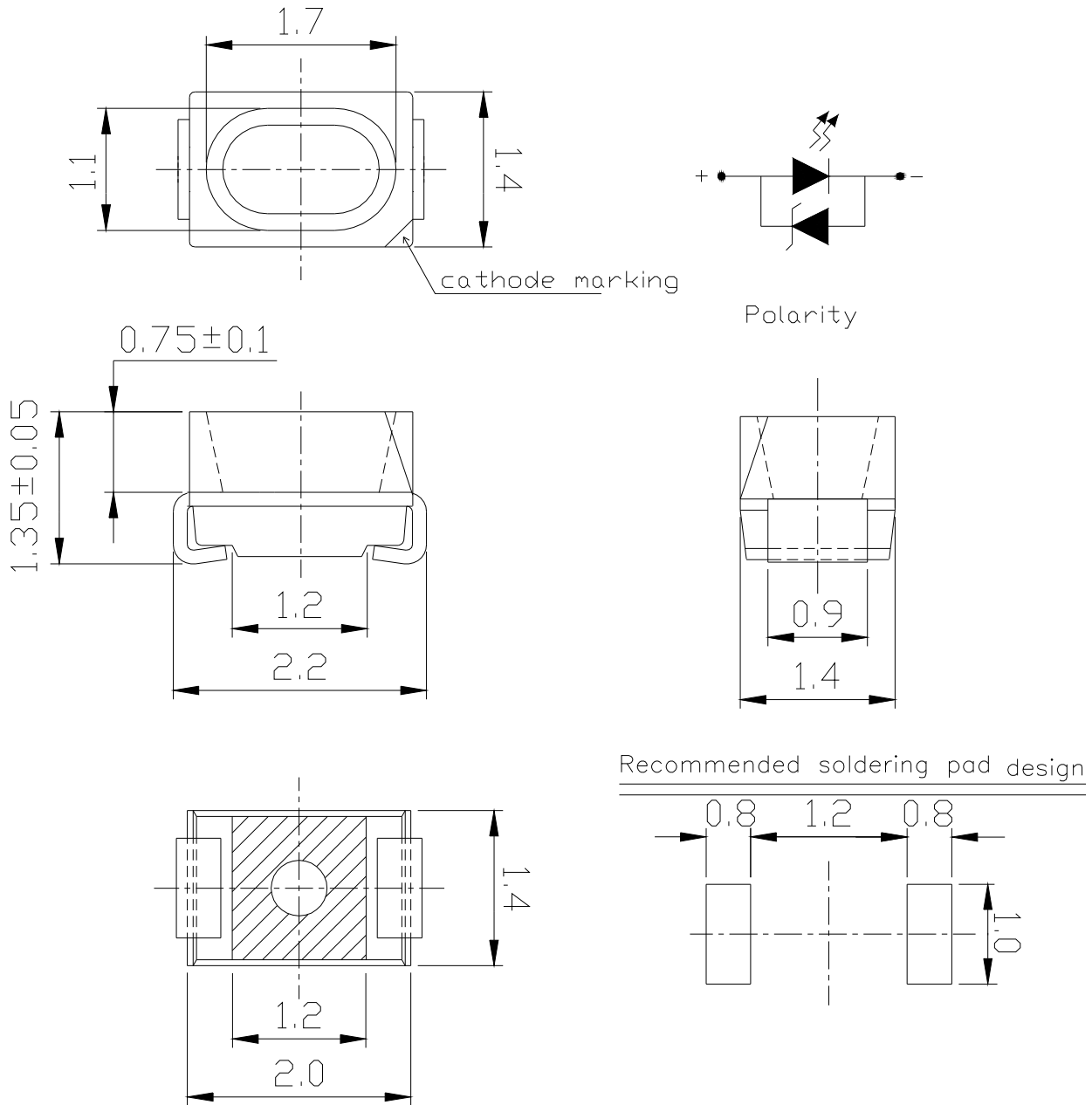

Note: The tolerances unless mentioned is ±0.1mm ,Unit = mm

65-11UTC/S933/TR8

Absolute Maximum Ratings (Ta=25)

Parameter	Symbol	Rating	Unit
Reverse Voltage	V _R	5	V
Forward Current	I _F	30	mA
Peak Forward Current (Duty 1/10 @1KHz)	I _{FP}	100	mA
Power Dissipation	P _d	110	mW
Electrostatic Discharge(HBM)	ESD	2000	V
Operating Temperature	T _{opr}	-40 ~ +85	
Storage Temperature	T _{stg}	-40 ~ +90	
Soldering Temperature	T _{sol}	Reflow Soldering : 260 for 10 sec. Hand Soldering : 350 for 3 sec.	

Electro-Optical Characteristics (Ta=25)

Parameter	Symbol	Min.	Typ.	Max.	Units	Condition
Luminous Intensity	I _v	1000	-----	1800	mcd	I _F =20mA
Viewing Angle	2 1/2	--	120	--	deg	I _F =20mA
Forward Voltage	V _F	2.70	-----	3.50	V	I _F =20mA

Notes:

- 1.Tolerance of Luminous Intensity ±11%
- 2.Tolerance of Forward Voltage ±0.05V

65-11UTC/S933/TR8

Bin Range Of Luminous Intensity

Bin Code	Min.	Max.	Unit	Condition
V2-1	1000	1120	mcd	I _F =20mA
W1	1120	1420		
W2	1420	1800		

Bin Range Of Forward Voltage

Group	Bin Code	Min.	Max.	Unit	Condition
B14	34	2.70	2.80	V	I _F =20mA
	35	2.80	2.90		
	36	2.90	3.00		
	37	3.00	3.10		
	38	3.10	3.20		
	39	3.20	3.30		
	40	3.30	3.40		
	41	3.40	3.50		

Notes:

- 1.Tolerance of Luminous Intensity $\pm 11\%$
- 2.Tolerance of Forward Voltage $\pm 0.05V$

Chromaticity Coordinates Specifications for Bin Grading

$I_F=20mA$

Bin Code	CIE_x	CIE_y	Bin Code	CIE_x	CIE_y
CC0-1	0.330	0.339	CC0-2	0.338	0.345
	0.330	0.360		0.335	0.360
	0.335	0.360		0.340	0.360
	0.338	0.345		0.345	0.350
CC0-3	0.33	0.318	CC0-4	0.340	0.329
	0.33	0.339		0.338	0.345
	0.338	0.345		0.345	0.350
	0.340	0.329		0.350	0.340

*The C.I.E. 1931 chromaticity diagram (Tolerance ± 0.01).

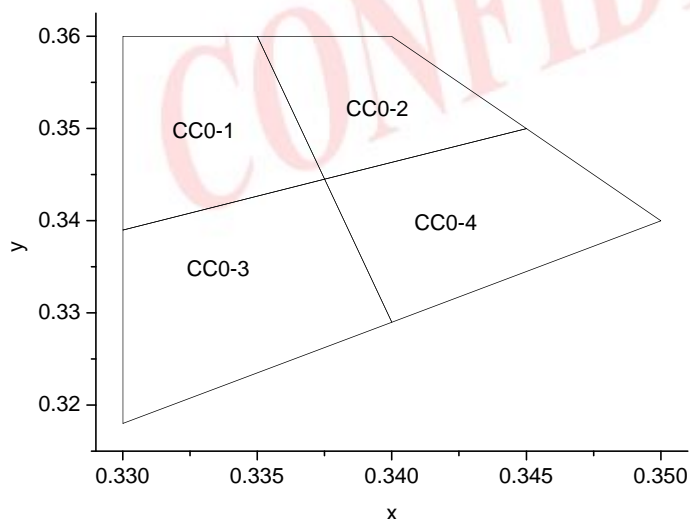

Typical Electro-Optical Characteristics Curves

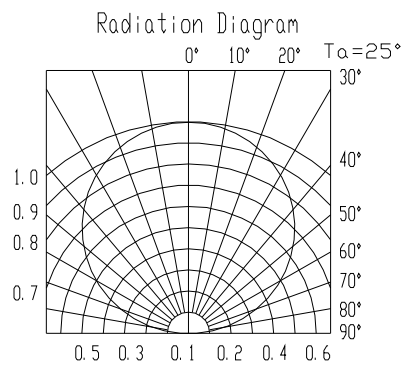
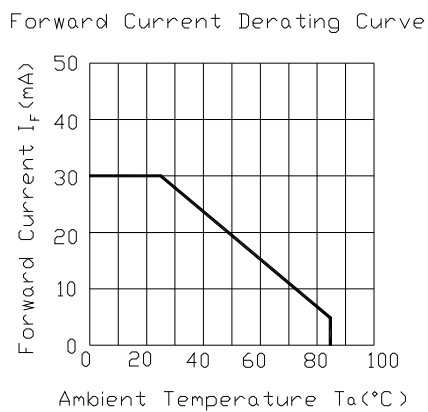
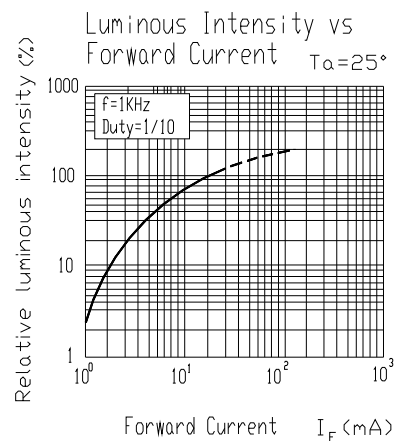
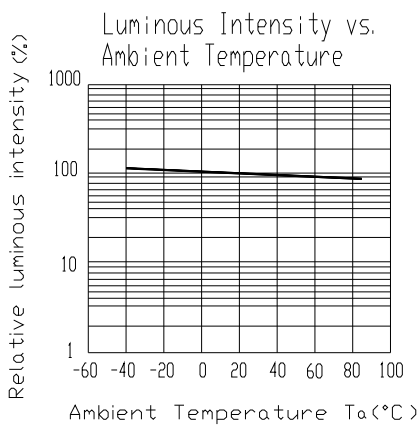
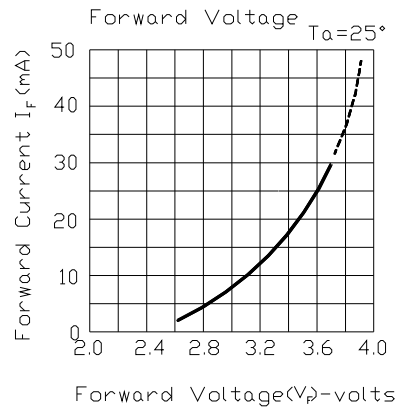
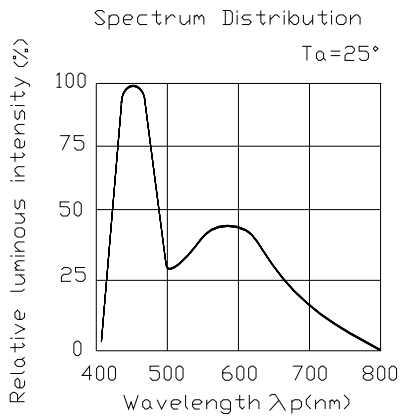

Label explanation

CAT: Luminous Intensity Rank

HUE: Chromaticity Coordinates

REF: Forward Voltage Rank

EVERLIGHT



CPN: XXXXXX
 P/N: XXXXXX



RoHS

XXXXXXXXXXXXXXXXXXXX
 QTY: XXXX



LOT NO: XXXXXXXXXXXX



CAT:
 HUE:
 REF:

MADE IN TAIWAN

Reel Dimensions

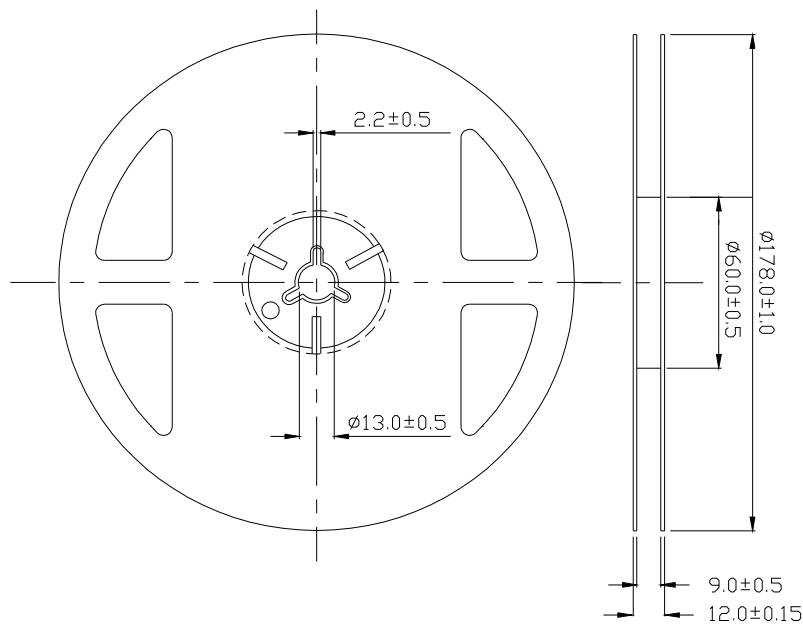

Note: The tolerances unless mentioned is ±0.1mm ,Unit = mm

Carrier Tape Dimensions: Loaded quantity 2000 PCS per reel.

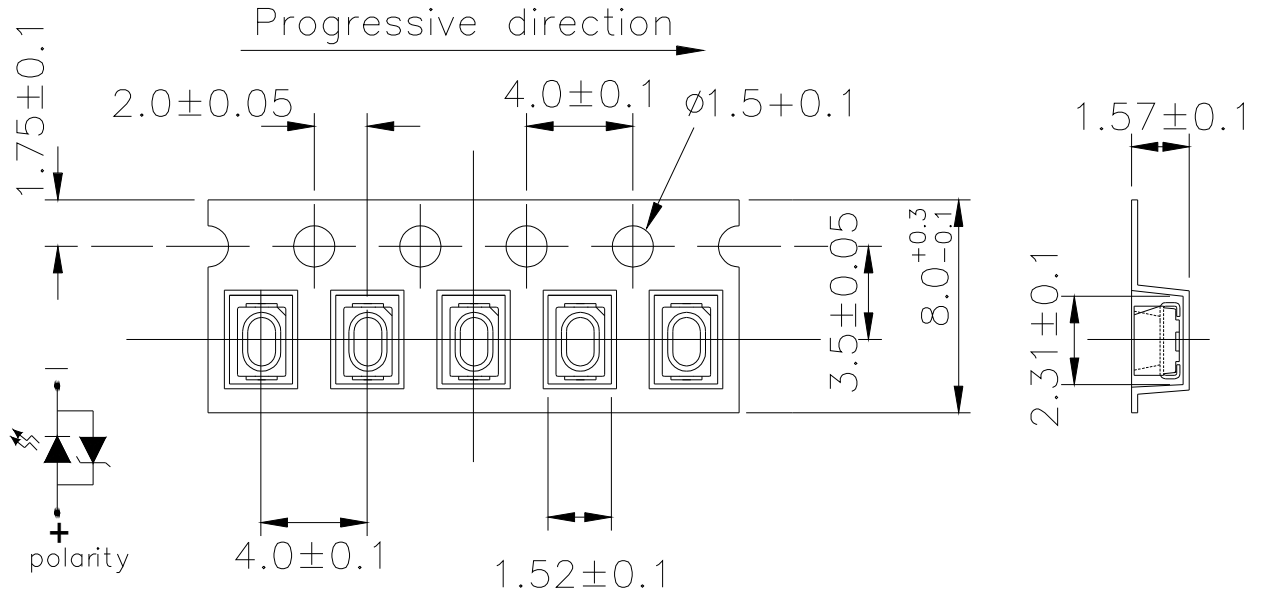

Note: The tolerances unless mentioned is ± 0.1 mm ,Unit = mm

Moisture Resistant Packaging

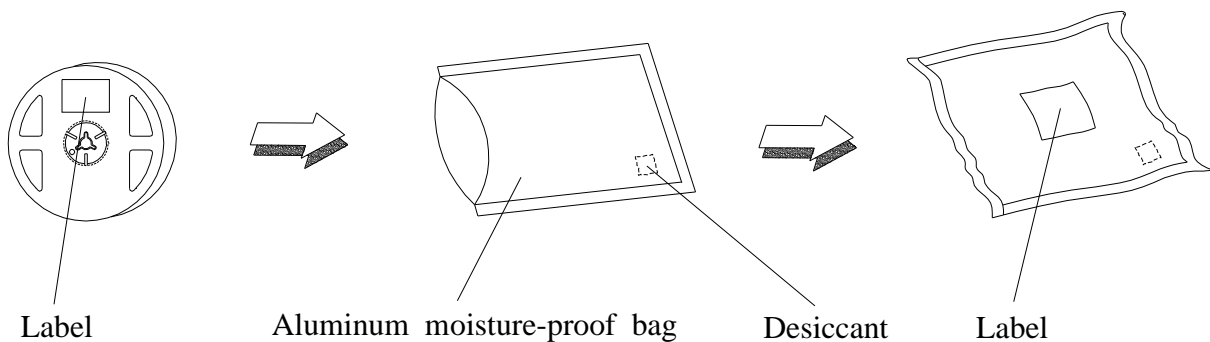

Reliability Test Items And Conditions

The reliability of products shall be satisfied with items listed below.

Confidence level : 90%

LTPD : 10%

No.	Items	Test Condition	Test Hours/Cycles	Sample Size	Ac/Re
1	Reflow Soldering	Temp. : 260 ±5 Min. 5sec.	6 min	22 PCS.	0/1
2	Temperature Cycle	H : +100 15min 5 min L : -40 15min	300 Cycles	22 PCS.	0/1
3	Thermal Shock	H : +100 5min 10 sec L : -10 5min	300 Cycles	22 PCS.	0/1
4	High Temperature Storage	Temp. : 100	1000 Hrs.	22 PCS.	0/1
5	Low Temperature Storage	Temp. : -40	1000 Hrs.	22 PCS.	0/1
6	DC Operating Life	IF = 20 mA / 25	1000 Hrs.	22 PCS.	0/1
7	High Temperature / High Humidity	85 / 85%RH	1000 Hrs.	22 PCS.	0/1

Precautions For Use

1. Over-current-proof

Customer must apply resistors for protection, otherwise slight voltage shift will cause big current change (Burn out will happen).

2. Storage

2.1 Do not open moisture proof bag before the products are ready to use.

2.2 Before opening the package: The LEDs should be kept at 30 or less and 90%RH or less.

2.3 After opening the package: The LED's floor life is 1 year under 30 or less and 60% RH or less.

If unused LEDs remain, it should be stored in moisture proof packages.

2.4 If the moisture absorbent material (silica gel) has faded away or the LEDs have exceeded the storage time, baking treatment should be performed using the following conditions.

Baking treatment : 60±5 for 24 hours.

3. Soldering Condition

3.1 Pb-free solder temperature profile

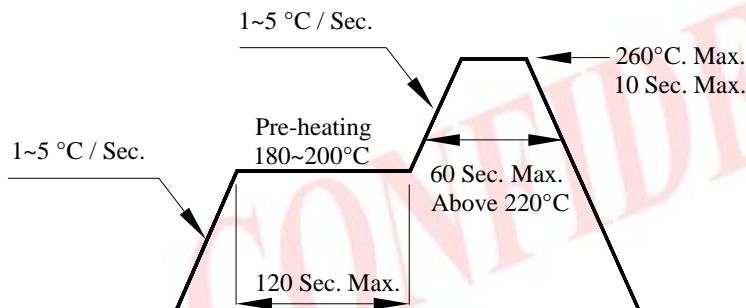

3.2 Reflow soldering should not be done more than two times.

3.3 When soldering, do not put stress on the LEDs during heating.

3.4 After soldering, do not warp the circuit board.

4.Soldering Iron

Each terminal is to go to the tip of soldering iron temperature less than 350 for 3 seconds within once in less than the soldering iron capacity 25W. Leave two seconds and more intervals, and do soldering of each terminal. Be careful because the damage of the product is often started at the time of the hand solder.

5.Repairing

Repair should not be done after the LEDs have been soldered. When repairing is unavoidable, a double-head soldering iron should be used (as below figure). It should be confirmed beforehand whether the characteristics of the LEDs will or will not be damaged by repairing.

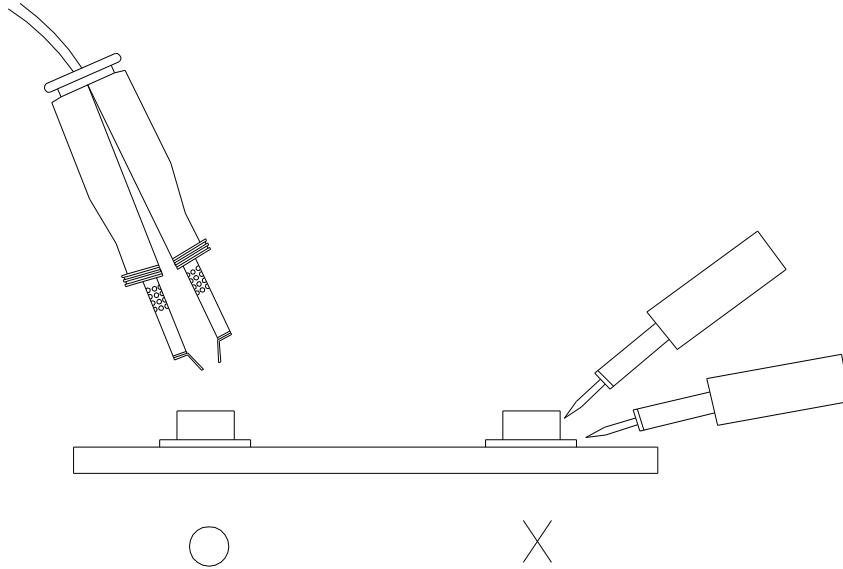

CONFIDENTIAL

EVERLIGHT ELECTRONICS CO., LTD.
Office: No 25, Lane 76, Sec 3, Chung Yang Rd,
Tucheng, Taipei 236, Taiwan, R.O.C

Tel: 886-2-2267-2000, 2267-9936
Fax: 886-2267-6244, 2267-6189, 2267-6306
<http://www.everlight.com>