



# Technical Data Sheet

## HIGH POWER LED

**32-01UBGC/S463**

### Benefits

- . Fewer LEDs Required
- . Lower Lighting System Cost
- . Wide viewing angle 130°



### Features

- . High Flux Output.
- . Low Profile.
- . Low Thermal Resistance.
- . Low Power Consumption.
- . Pb free.
- . The product itself will remain within RoHS compliant version.

### Descriptions

This revolutionary package design allows the light designer to reduce the number of LEDs required and provide a more uniform and unique illuminated appearance than with other LED solutions. This is possible through the efficient optical package design and high-current capabilities.

The low profile package can be easily coupled with reflectors or lenses to efficiently distribute light and provide the desired light appearance.

### Applications

- . Automotive Exterior Lighting
- . Electronic Signs and Signals
- . Special Lighting application

### Device Selection Guide

PART NO.	Chip		Lens Color
	Material	Emitted Color	
32-01UBGC/S463	InGaN/Sapphire	Bluish Green	Water Clear

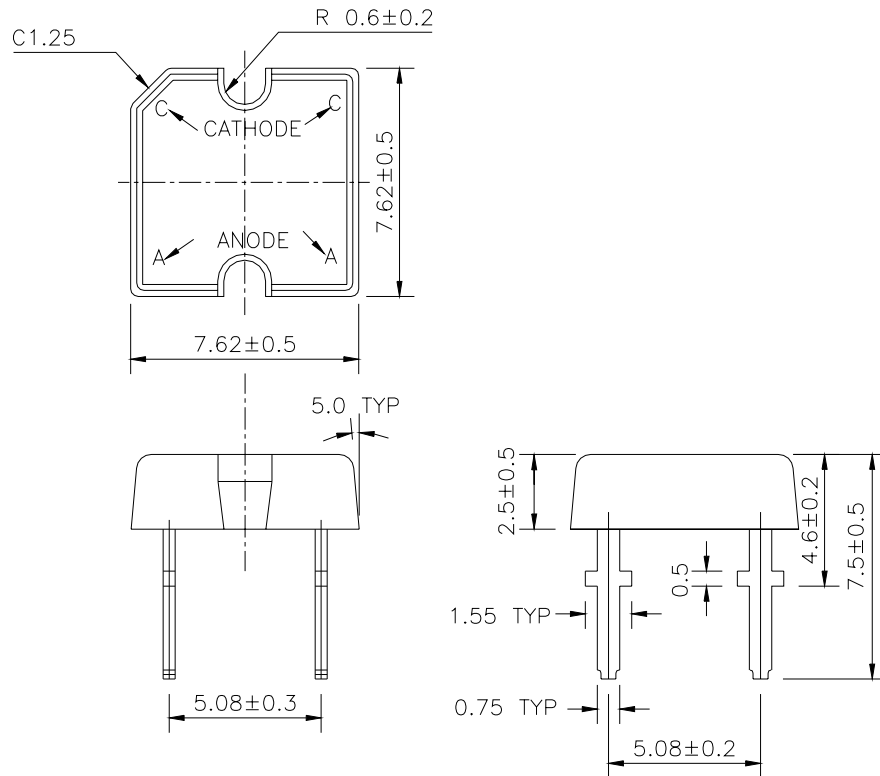
**Package Dimensions**

- Notes:**
- 1.All dimensions are in millimeters
  - 2.An epoxy meniscus may extend about 1.5mm(0.059") down the leads
  - 3.Tolerances unless dimensions  $\pm 0.25$ mm

**Absolute Maximum Ratings (Ta=25°C)**

Parameter	Symbol	Rating	Units
Continuous Forward Current	$I_F$	30	mA
Peak Forward Current(Duty 1/10 @ 1KHZ)	$I_{FP}$	100	mA
Reverse Voltage	$V_R$	5	V
Operating Temperature	$T_{opr}$	-40 ~ +85	°C
Storage Temperature	$T_{stg}$	-40 ~ +100	°C
Soldering Temperature(T=5 sec)	$T_{sol}$	$260 \pm 5$	°C
Power Dissipation	$P_d$	120	mW
Electrostatic Discharge	ESD	150	V

**Electro-Optical Characteristics (Ta=25°C)**

Parameter	Symbol	Min.	Typ.	Max.	Condition	Unit
Total Flux	$\Phi_v$	360	600	----	$I_F=20\text{mA}$	mlm
Viewing Angle	$2\theta_{1/2}$	----	130	----	$I_F=20\text{mA}$	deg
Peak Wavelength	$\lambda_p$	----	502	----	$I_F=20\text{mA}$	nm
Dominant Wavelength	$\lambda_d$	----	505	----	$I_F=20\text{mA}$	nm
Spectrum Radiation Bandwidth	$\Delta\lambda$	----	30	----	$I_F=20\text{mA}$	nm
Forward Voltage	$V_F$	----	3.5	----	$I_F=20\text{mA}$	V
Reverse Current	$I_R$	----	----	50	$V_R=5\text{V}$	$\mu\text{A}$

**Rank**

32-01UBGC/S463

<input type="checkbox"/>	<input type="checkbox"/>	<input type="checkbox"/>
(1)	(2)	(3)

(1) $V_F(\text{v})$			(2) $\lambda_d(\text{nm})$			(3) $\Phi_v(\text{mlm})$		
Bin	Min	Max	Bin	Min	Max	Bin	Min	Max
0	2.80	3.00	0	494	501	V	360	750
1	3.00	3.20	1	499	506	W	600	1200
2	3.20	3.40	2	504	511	X	960	1920
3	3.40	3.60	3	509	516			
4	3.60	3.80						
5	3.80	4.00						

 \*Measurement Uncertainty of Forward Voltage :  $\pm 0.1\text{V}$ 

 \*Measurement Uncertainty of Luminous Intensity:  $\pm 15\%$

**Typical Electro-Optical Characteristics Curves**

**Relative Intensity vs. Wavelength**

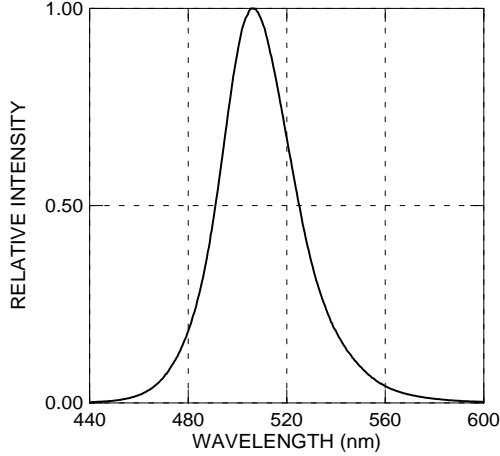

**Forward Current vs. Forward Voltage**

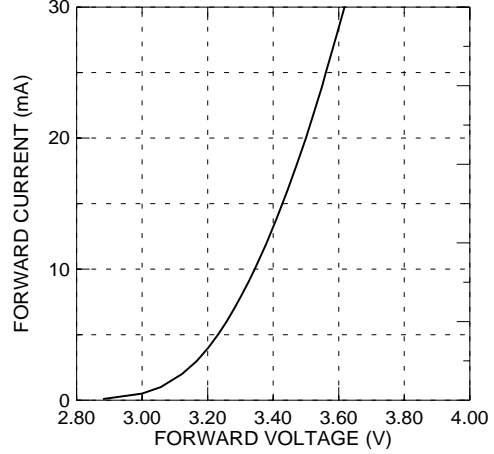

**Relative Intensity vs. Forward Current**

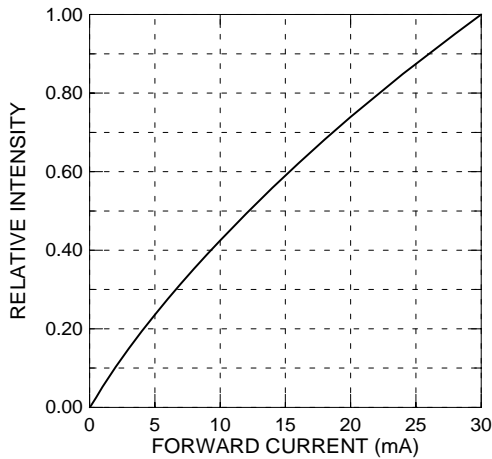

**Forward Current vs. Ambient Temp.**

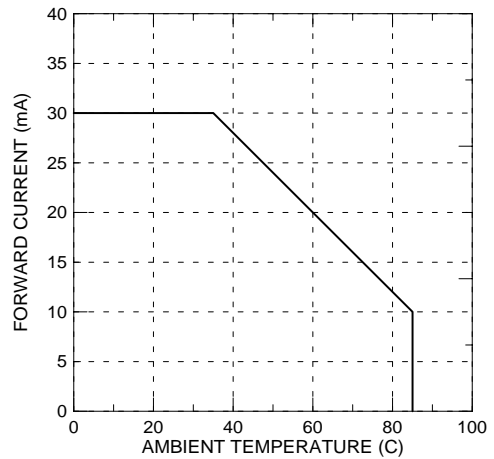

**Relative Intensity vs. Angle Displacement**

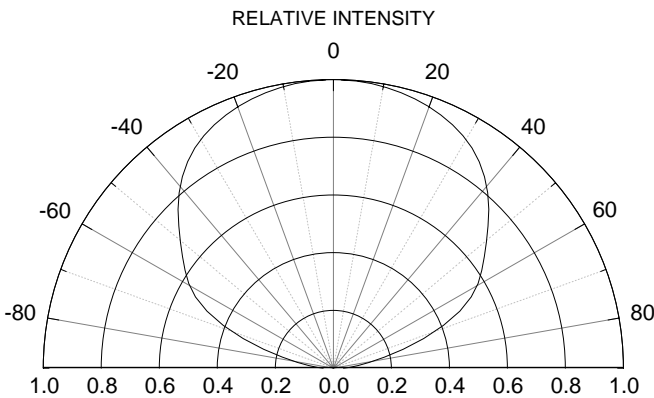

**Relative Intensity vs. Off Axis Angle**

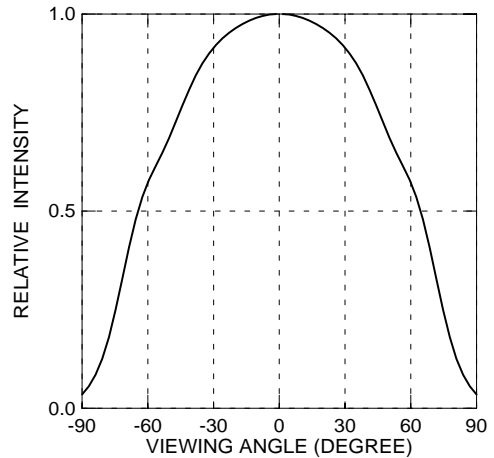

**Label Form Specification**



CPN: Customer's Production Number  
P/N : Production Number  
QTY: Packing Quantity  
CAT: Color Bin Grade  
HUE: Space  
REF: Reference  
LOT No: Lot Number  
MADE IN TAIWAN: Production Place

**Notes**

1. Above specification may be changed without notice. EVERLIGHT will reserve authority on material change for above specification.
2. When using this product, please observe the absolute maximum ratings and the instructions for using outlined in these specification sheets. EVERLIGHT assumes no responsibility for any damage resulting from use of the product which does not comply with the absolute maximum ratings and the instructions included in these specification sheets.
3. These specification sheets include materials protected under copyright of EVERLIGHT corporation. Please don't reproduce or cause anyone to reproduce them without EVERLIGHT's consent.

<b>EVERLIGHT ELECTRONICS CO., LTD.</b> Office: No 25, Lane 76, Sec 3, Chung Yang Rd, Tucheng, Taipei 236, Taiwan, R.O.C	Tel: 886-2-2267-2000, 2267-9936 Fax: 886-2267-6244, 2267-6189, 2267-6306 <a href="http://www.everlight.com">http://www.everlight.com</a>
---	--