



# EVERLIGHT ELECTRONICS CO.,LTD.

PART NO : 31-01SUBC Device Number : DLE-301-007 REV: 1.3  
 ECN : \_\_\_\_\_ Page: 1/4

## Benefits :

- Fewer LEDs Required
- Lowers Lighting System Cost

## Features :

- High Flux Output.
- Designed for High Current Operation.
- Low Thermal Resistance.
- Low Profile.
- Packaged in Tubes for Use with Automatic Insertion Equipment.



## Applications :

- Automotive Exterior Lighting
- Electronic Signs and Signals

## Description :

This revolutionary package design allows the lighting designer to reduce the number of LEDs required and provide a more uniform and unique illuminated appearance than with other LED solutions.

This is possible through the efficient optical package design and high-current capabilities.

The low profile package can be easily coupled with reflectors or lenses to efficiently distribute light and provide the desired lit appearance.

This product family employs the world's brightest red-orange and amber LED materials, which allow designers to match the color of popular lighting applications, such as automotive tail, stop, and turn signal lamps, and electronic signs.

PART NO	Chip		Lens Color
	Material	Emitted Color	
31-01SUBC	GaN	Super Blue	Water Clear

OFFICE : NO. 25, Lane 76, Sec.3, Chung Yang Rd., Tucheng 236, Taipei, Taiwan, R.O.C.

TEL : 886-2-2267-2000, 2267-9936

FAX : 886-2-2267-6244, 22676189, 22676306

<http://www.everlight.com>



Device Number : DLE-301-007 REV: 1.3  
 PART NO : 31-01SUBC ECN :                      Page: 2/4

### Absolute Maximum Ratings at $T_a = 25^\circ\text{C}$

Parameter	Symbol	Rating	Unit
Forward Current	$I_F$	30	mA
Operating Temperature	$T_{opr}$	-20 to +80	$^\circ\text{C}$
Storage Temperature	$T_{opr}$	-30 to +100	$^\circ\text{C}$
Soldering Temperature	$T_{sol}$	$260 \pm 5$	$^\circ\text{C}$
Electrostatic Discharge	ESD	150	V
Power Dissipation	$P_d$	120	mW
Peak Forward Current(Duty 1/10 @ 1KHz)	$I_F(\text{Peak})$	100	mA
Reverse Voltage	$V_R$	5	V

### Package Dimensions:

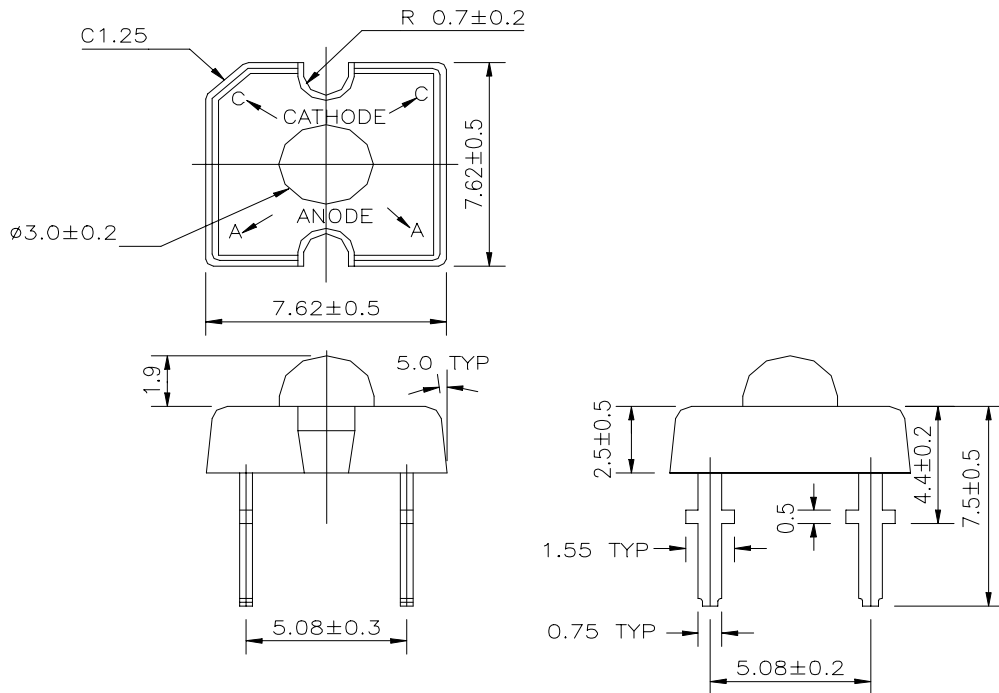

### Notes :

- 1.All dimensions are millimeter.(inch)
- 2.An epoxy meniscus may extend about 1.5mm(0.059") down the lead.



# EVERLIGHT ELECTRONICS CO.,LTD.

Device Number : DLE-301-007 REV: 1.3  
 PART NO : 31-01SUBC ECN :          Page: 3/4

## ■ Electro-Optical Characteristics :

Parameter	Symbol	Min.	Typ.	Max.	Condition	Unit
Total Flux	$\Phi_v$	250	400	----	$I_F=20mA$	mlm
Viewing Angle	$2\theta_{1/2}$	----	30	----	$I_F=20mA$	deg
Peak Wavelength	$\lambda_p$	----	466	----	$I_F=20mA$	nm
Dominant Wavelength	$\lambda_d$	----	470	----	$I_F=20mA$	nm
Spectrum Radiation Bandwidth	$\Delta\lambda$	----	35	----	$I_F=20mA$	nm
Forward Voltage	$V_F$	----	3.5	4.3	$I_F=20mA$	V
Reverse Current	$I_R$	----	----	50	$V_R=5V$	$\mu A$
Recommended Operating Current	$I_F$ (Rec)	----	----	20		mA
DC Forward Current	$I_F$ (mA)	----	----	30		mA

## ■ Reliability test items and conditions

NO	Item	Test Conditions	Test Hours/Cycle	Sample Size		Ac/Re
1	Solder Heat	TEMP:260°C ± 5 °C	5 SEC	76 PCS		0/1
2	Temperature Cycle	H : +85°C 30min ∩ 5 min L : -55°C 30min	50 CYCLES	76 PCS		0/1
3	Thermal Shock	H : +100°C 5min ∩ 10 sec L : -10°C 5min	50 CYCLES	76 PCS		0/1
4	High Temperature Storage	TEMP : 100°C	1000 HRS	76 PCS		0/1
5	Low Temperature Storage	TEMP : -55°C	1000 HRS	76 PCS		0/1
6	DC Operating Life	$I_F$ (max) mA	1000 HRS	76 PCS		0/1
7	High Temperature / High Humidity	85°C/85% RH	1000 HRS	76 PCS		0/1



Device Number : DLE-301-007      REV: 1.3  
 PART NO : 31-01SUBC      ECN : \_\_\_\_\_      Page: 4/4

■ Typical Electro-Optical Characteristic Curves

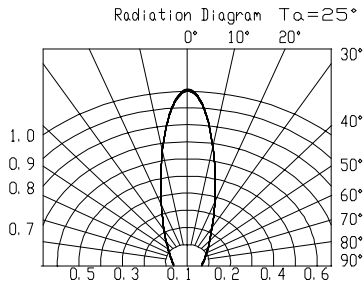
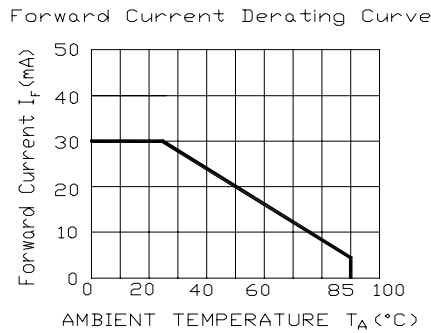
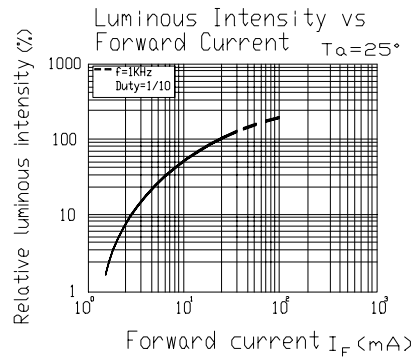
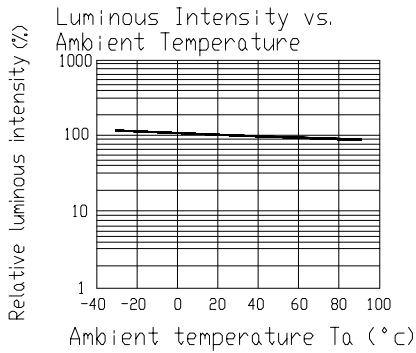
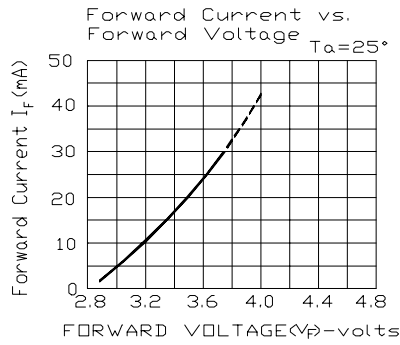
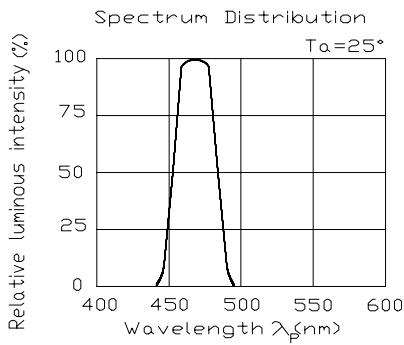

■ Specifications for Bin Grading

$\Phi v$ (mlm)					
Bin			Min		Max
T			250		500
U			400		800
V			630		1250
W			1000		2000