



Technical Data Sheet

HIGH POWER LED

30-01UWC/MB

Benefits

- . Fewer LEDs Required
- . Lower Lighting System Cost
- . Wide viewing angle 60°
- . Typical chromaticity coordinates $x=0.29$, $y=0.30$ according to CIE1931.

Features

- . High Flux Output.
- . Low Profile.
- . Low Thermal Resistance.
- . Low Power Consumption
- . The phosphor filled in the reflector converts the blue emission of InGaN chip to ideal white.
- . Pb free.
- . The product itself will remain within RoHS compliant version



Descriptions

This revolutionary package design allows the light designer to reduce the number of LEDs required and provide a more uniform and unique illuminated appearance than with other LED solutions. This is possible through the efficient optical package design and high-current capabilities.

The low profile package can be easily coupled with reflectors or lenses to efficiently distribute light and provide the desired light appearance.

Applications

- . Automotive Exterior Lighting
- . Electronic Signs and Signals
- . Special Lighting application

Device Selection Guide

PART NO.	Chip		Lens Color
	Material	Emitted Color	
30-01UWC/MB	InGaN/SiC	White	Water Clear

Package Dimensions

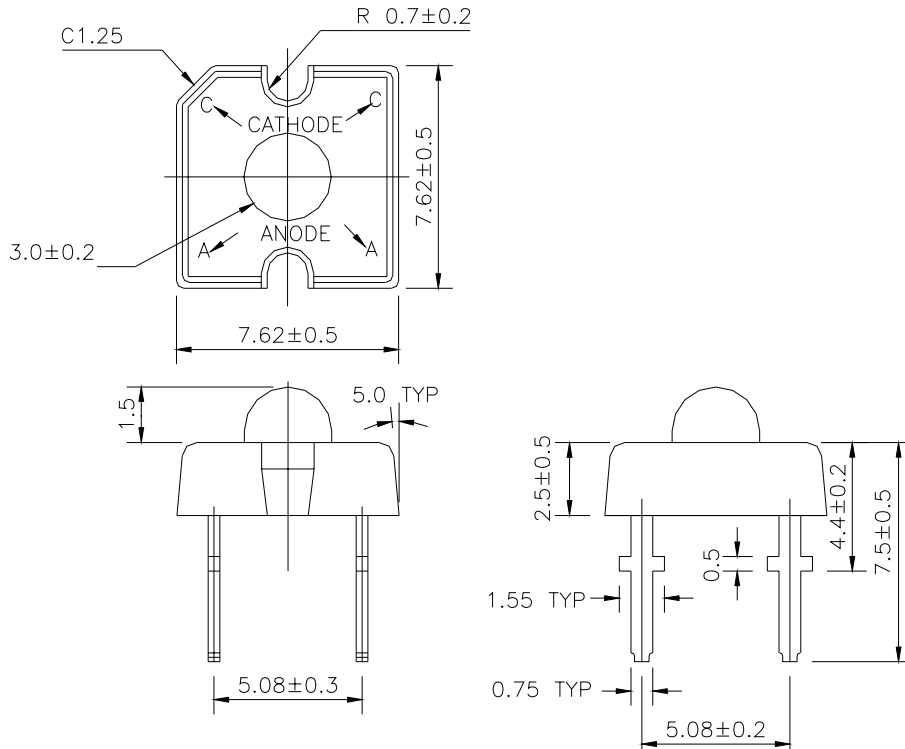

- Notes:**
1. All dimensions are in millimeters
 2. An epoxy meniscus may extend about 1.5mm(0.059") down the leads
 3. Tolerances unless dimensions ±0.25mm

Absolute Maximum Ratings (Ta=25°C)

Parameter	Symbol	Rating	Units
Continuous Forward Current	I _F	30	mA
Peak Forward Current(Duty 1/10 @ 1KHZ)	I _{FP}	100	mA
Reverse Voltage	V _R	5	V
Operating Temperature	T _{opr}	-40 ~ +85	°C
Storage Temperature	T _{stg}	-40 ~ +100	°C
Soldering Temperature(T=5 sec)	T _{sol}	260 ± 5	°C
Power Dissipation	P _d	129	mW
Electrostatic Discharge	ESD	1000	V

Electro-Optical Characteristics (Ta=25°C)

Parameter	Symbol	Min.	Typ.	Max.	Condition	Unit
Forward Voltage	V _F	----	3.5	4.3	I _F =20mA	V
Reverse Current	I _R	----	----	50	V _R =5V	mA
Total Flux	Φ _v	500	800	----	I _F =20mA	mlm
Viewing Angle	2θ 1/2	----	60	----	I _F =20mA	deg
Chromaticity Coordinates	x	----	0.29	----	I _F =20mA	----
	y	----	0.30	----		----

Rank

30-01UWC/MB

 (1) (2) (3)

(1) V _F (V)			(2) Color			(3) Φ _v (mlm)		
Bin.	Min.	Max.	Bin.	Min.	Max.	Bin.	Min.	Max.
0	2.80	3.00	A1	----	----	U	500	800
1	3.00	3.20	A2	----	----	V	630	1250
2	3.20	3.40	B1	----	----	W	1000	2000
3	3.40	3.60	B2	----	----	X	1600	3200
4	3.60	3.80	C1	----	----			
5	3.80	4.00	C2	----	----			
6	4.00	4.20	D1	----	----			
7	4.20	4.40	D2	----	----			

*Measurement Uncertainty of Forward Voltage : ±0.1V

*Measurement Uncertainty of Luminous Intensity: ±15%

CIE Chromaticity Diagram

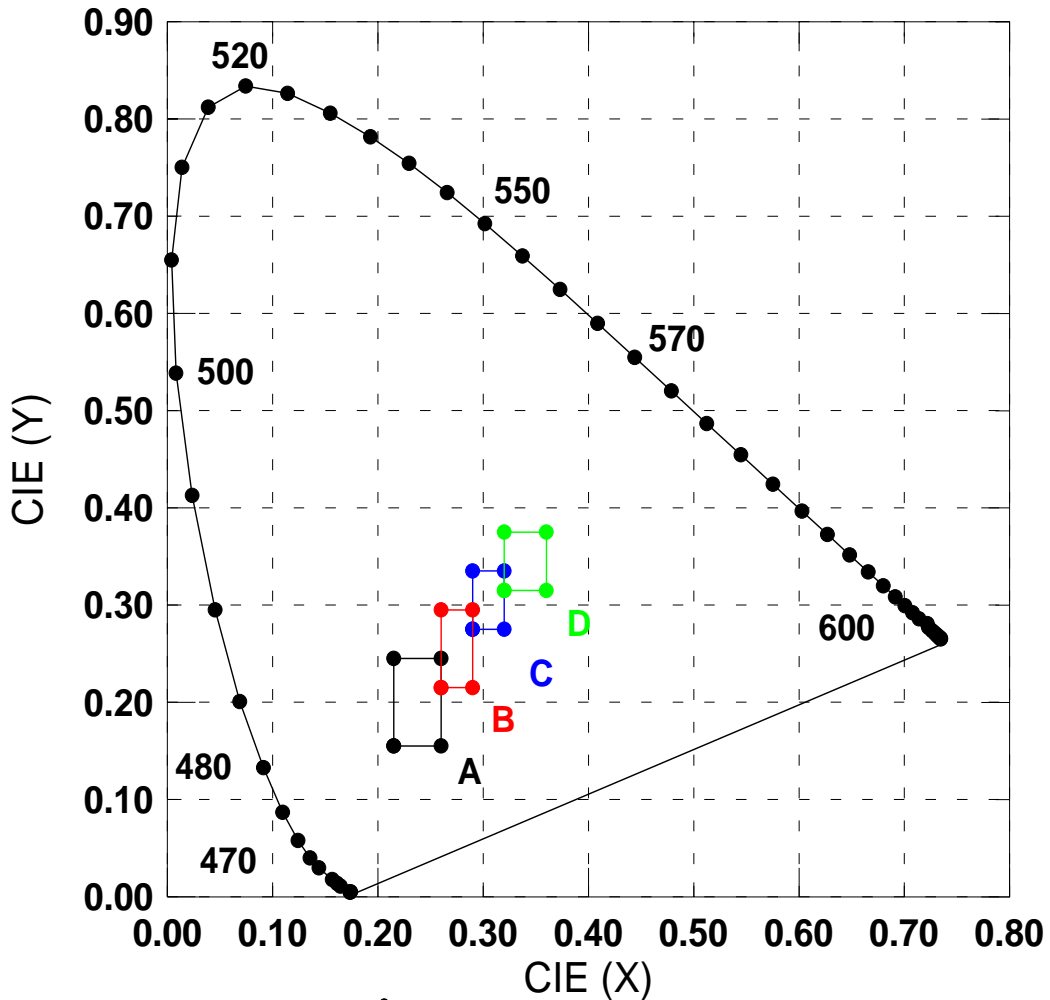

Color Ranks (IF=20mA , Ta=25°C)

Color Ranks	CIE X		CIE Y	
	Min.	Max.	Min.	Max.
A1	0.215	0.245	0.155	0.215
A2	0.245	0.260	0.185	0.245
B1	0.260	0.275	0.215	0.275
B2	0.275	0.290	0.245	0.295
C1	0.290	0.305	0.275	0.315
C2	0.305	0.320	0.295	0.335
D1	0.320	0.340	0.315	0.355
D2	0.340	0.360	0.335	0.385

Measurement uncertainty of the color coordinates : ±0.01

Typical Electro-Optical Characteristics Curves

Relative Intensity vs. Wavelength

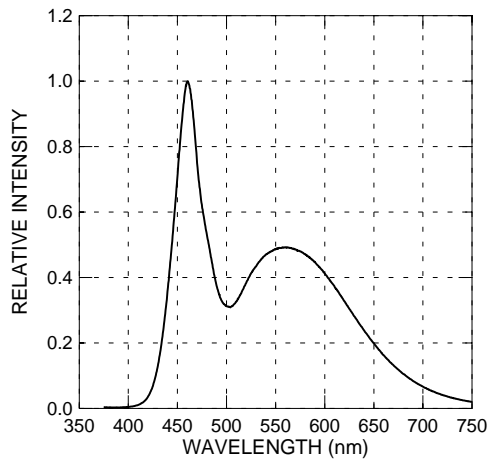

Forward Current vs. Forward Voltage

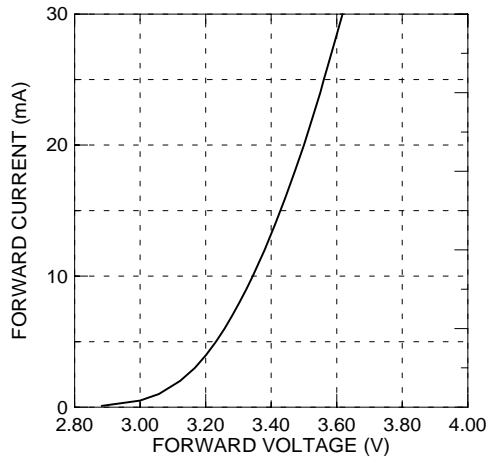

Relative Intensity vs. Forward Current

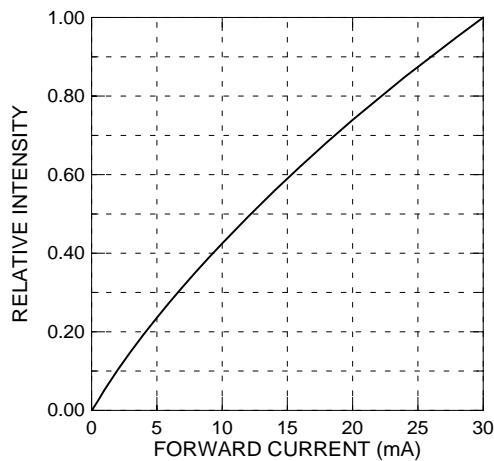

Forward Current vs. Ambient Temp.

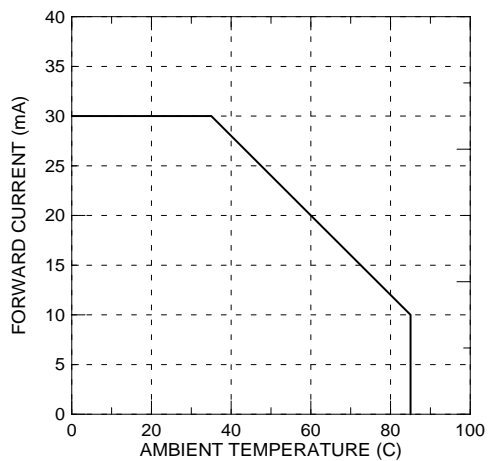

Chromaticity Coordinate vs. Forward Current

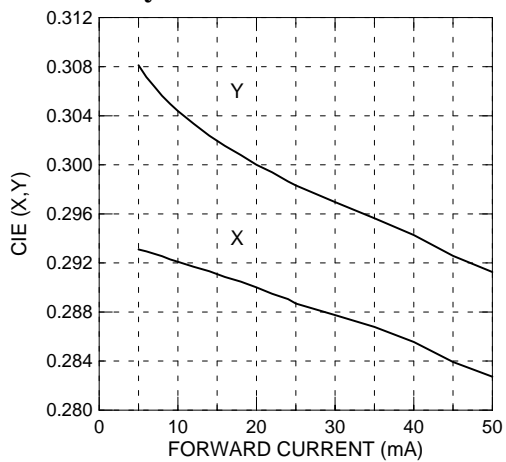

Radiation Characteristics

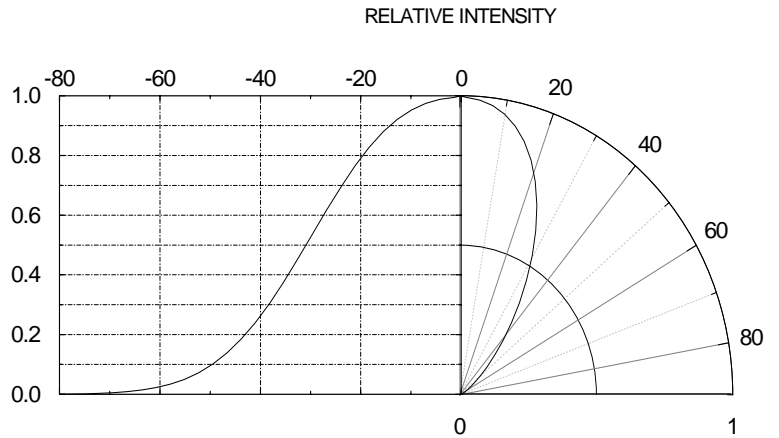

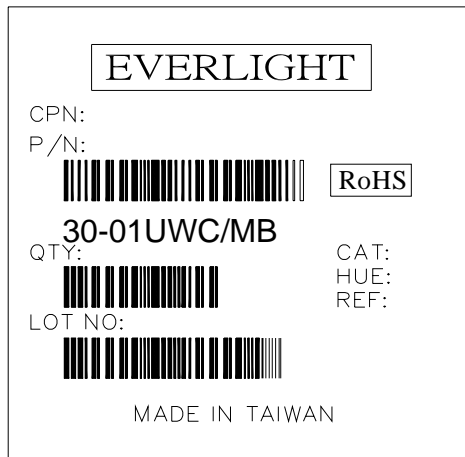
Label Form Specification

CPN: Customer's Production Number
P/N : Production Number
QTY: Packing Quantity
CAT: Color Bin Grade
HUE: Space
REF: Reference
LOT No: Lot Number
MADE IN TAIWAN: Production Place

Notes

1. Above specification may be changed without notice. EVERLIGHT will reserve authority on material change for above specification.
2. When using this product, please observe the absolute maximum ratings and the instructions for using outlined in these specification sheets. EVERLIGHT assumes no responsibility for any damage resulting from use of the product which does not comply with the absolute maximum ratings and the instructions included in these specification sheets.
3. These specification sheets include materials protected under copyright of EVERLIGHT corporation. Please don't reproduce or cause anyone to reproduce them without EVERLIGHT's consent.

EVERLIGHT ELECTRONICS CO., LTD.
Office: No 25, Lane 76, Sec 3, Chung Yang Rd,
Tucheng, Taipei 236, Taiwan, R.O.C

Tel: 886-2-2267-2000, 2267-9936
Fax: 886-2267-6244, 2267-6189, 2267-6306
<http://www.everlight.com>