

Technical Data Sheet

Power Top LEDs

67-31EZ-BLT-2AV2ABC2F-2T8-AM

Lead (Pb) Free Product - RoHS Compliant

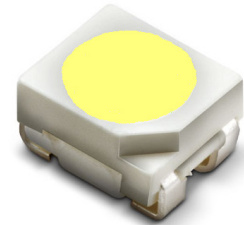

Feature

- P-LCC-3 package.
- Colorless clear resin.
- Wide viewing angle 120°.
- Inner reflector and white package.
- Brightness: 900 to 1800 mcd at 30mA.
- Precondition: Bases on JEDEC J-STD 020D Level 3.
- Qualification according to AEC-Q101 rev C.
- Automotive reflow profile (IR reflow or wave soldering)

Applications

- Automotive backlighting : Indicator and exterior automotive lighting (Dashboard backlighting, turn signal lamps, sidemakers, symbol and signal luminaire...etc.
- Backlight: LCD, switches, symbol, mobile phone and illuminated advertising.
- Display for indoor and outdoor application.
- Ideal for coupling into light guides.
- Substitution of traditional light.
- Optical indicator.
- General applications.

Device Selection Guide

Chip	Emitted Color	Resin Color
Material		
InGaN	White	Yellow

Technical Data Sheet

Power Top LEDs

67-31EZ-BLT-2AV2ABC2F-2T8-AM

Absolute Maximum Ratings (Ta=25°C)

Parameter	Symbol	Rating	Unit
Reverse Voltage	V _R	5	V
Forward Current	I _F	30	mA
Peak Forward Current (Duty 1/10 @1KHz)	I _{FP}	100	mA
Power Dissipation	P _d	110	mW
Junction Temperature	T _j	125	°C
Operating Temperature	T _{opr}	-40 ~ +100	°C
Storage Temperature	T _{stg}	-40 ~ +110	°C
Thermal resistance	R _{th J-A}	600	K/W
	R _{th J-S}	400	K/W
ESD (Classification acc. AEC Q101)	ESD _{HBM}	2000	V
	ESD _{MM}	200	V
Soldering Temperature	T _{sol}	Reflow Soldering : 260 °C for 30 sec. Hand Soldering : 350 °C for 3 sec.	

Technical Data Sheet

Power Top LEDs

67-31EZ-BLT-2AV2ABC2F-2T8-AM

Electro-Optical Characteristics (Ta=25°C)

Parameter	Symbol	Min.	Typ.	Max.	Unit	Condition
Luminous Intensity	I _v	900	-----	1800	mcd	I _F =30mA
Viewing Angle	2θ _{1/2}	-----	120	-----	deg	I _F =30mA
Forward Voltage	V _F	2.7	-----	3.9	V	I _F =30mA
Temperature coefficient of λ _p	TC _{λ_p}	---	0.06	---	nm/K	I _F =30mA
Temperature coefficient of λ _d	TC _{λ_d}	---	0.4	---	nm/K	I _F =30mA
Temperature coefficient of VF	TC _V	---	-2.3	---	mV/K	I _F =30mA

Notes :

1. Tolerance of Luminous Intensity: ±11%
2. Tolerance of Chromaticity Coordinates is ±0.01
3. Tolerance of Forward Voltage: ±0.1V

Technical Data Sheet

Power Top LEDs

67-31EZ-BLT-2AV2ABC2F-2T8-AM

Bin Range of Luminous Intensity

Bin Code	Min.	Max.	Unit	Condition
V2	900	1120	mcd	I _F =30mA
AA	1120	1400		
AB	1400	1800		

Notes : Tolerance of Luminous Intensity : ±11%

Bin Range of Forward Voltage

Bin Code	Min.	Max.	Unit	Condition
1	2.7	3	V	I _F =30mA
2	3	3.3		
3	3.3	3.6		
4	3.6	3.9		

Notes : Tolerance of Forward Voltage : ±0.05V

Technical Data Sheet

Power Top LEDs

67-31EZ-BLT-2AV2ABC2F-2T8-AM

Bin Range of Dominant Wavelength

Bin Code	CIE_x	CIE_y	Condition
2A	0.315	0.300	I _F = 30mA
	0.315	0.335	
	0.335	0.360	
	0.335	0.325	

Notes : Tolerance Chromaticity Coordinates : ±0.01

The C.I.E. 1931 Chromaticity Diagram

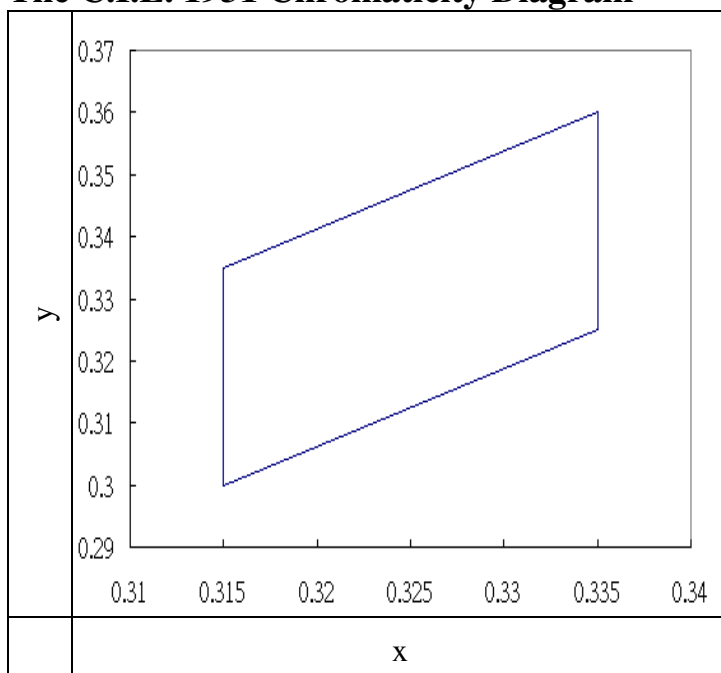

Technical Data Sheet

Power Top LEDs

67-31EZ-BLT-2AV2ABC2F-2T8-AM

Typical Electro-Optical Characteristics Curves

Typical Curve of Spectral Distribution

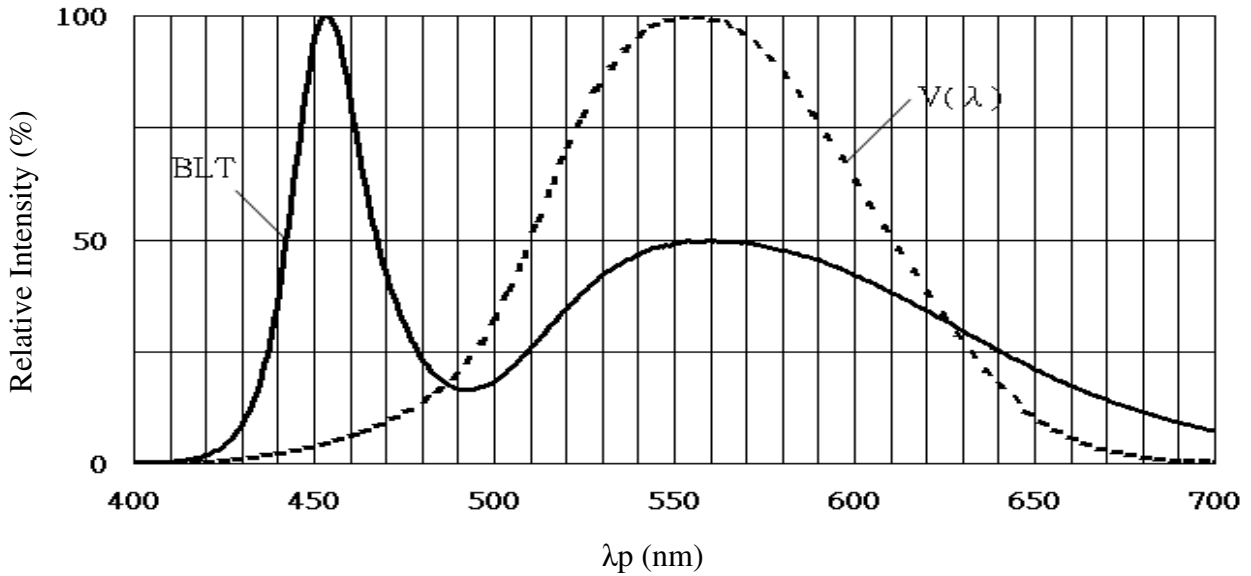

Note: V(λ)=Standard eye response curve

Diagram Characteristics of Radiation

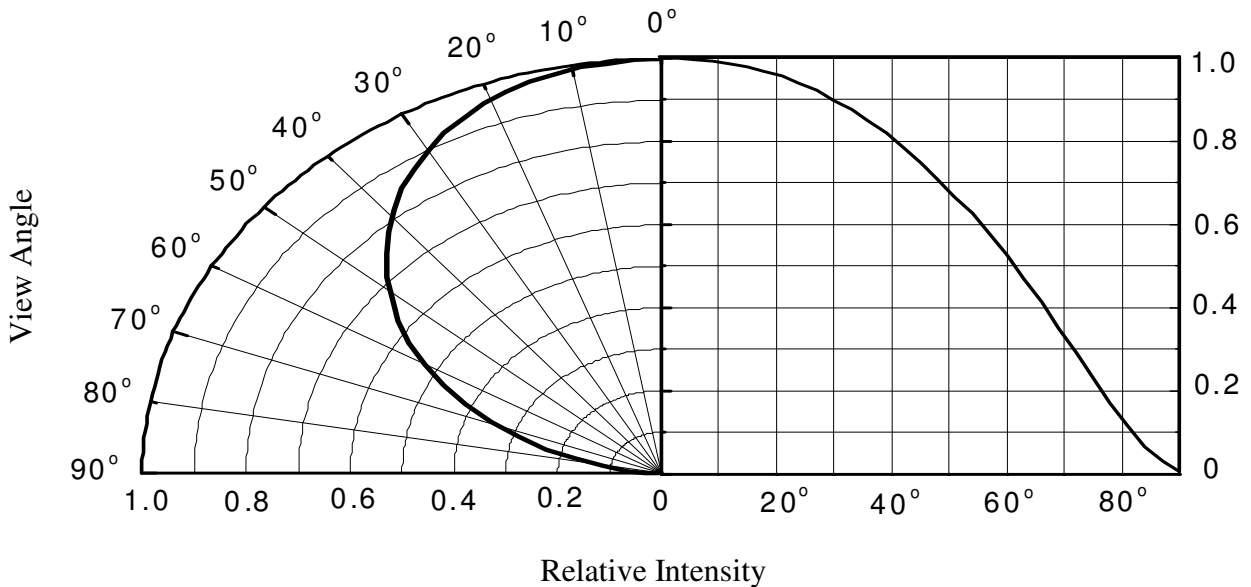

Technical Data Sheet

Power Top LEDs

67-31EZ-BLT-2AV2ABC2F-2T8-AM

Forward Current vs. Forward Voltage
(Ta=25°C)

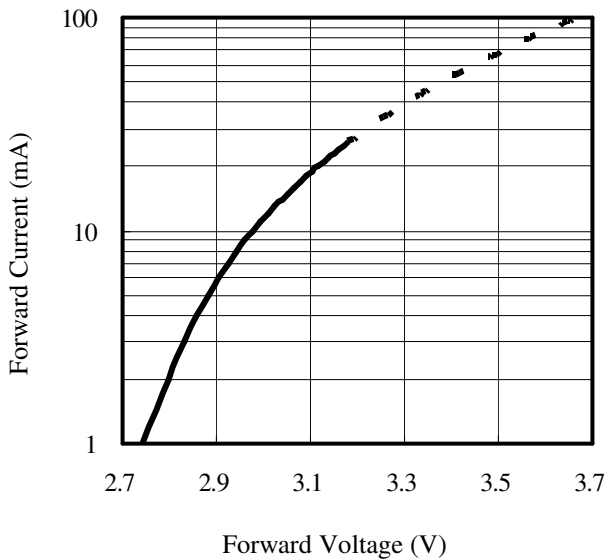

Chromaticity Coordinates vs. Forward Current
(Ta=25°C)

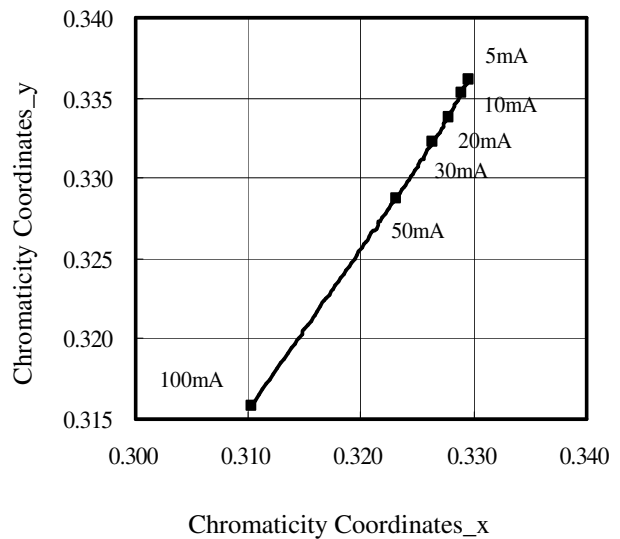

Relative Luminous Intensity vs. Forward Current
(Ta=25°C)

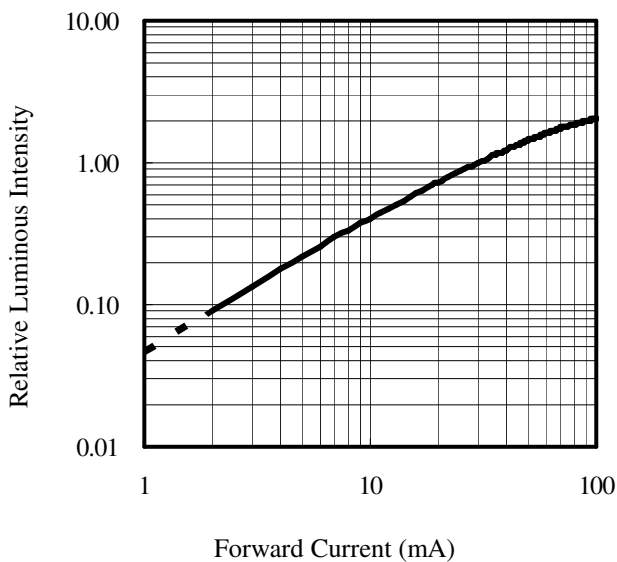

Forward current vs. Ambient and Solder Temperature

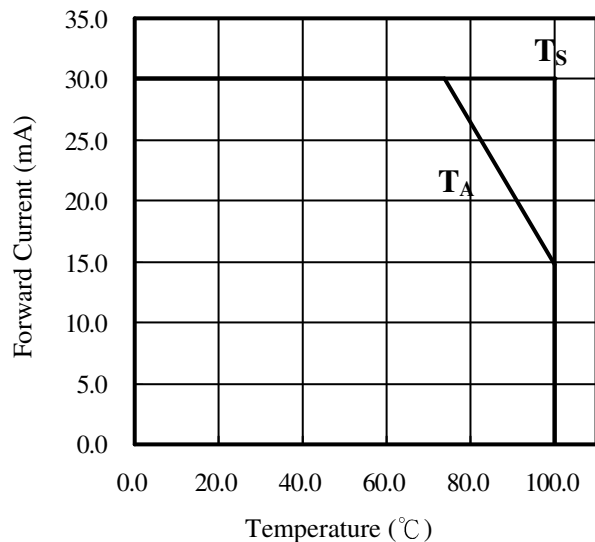

Technical Data Sheet

Power Top LEDs

67-31EZ-BLT-2AV2ABC2F-2T8-AM

Relative Luminous Intensity vs. Junction Temperature

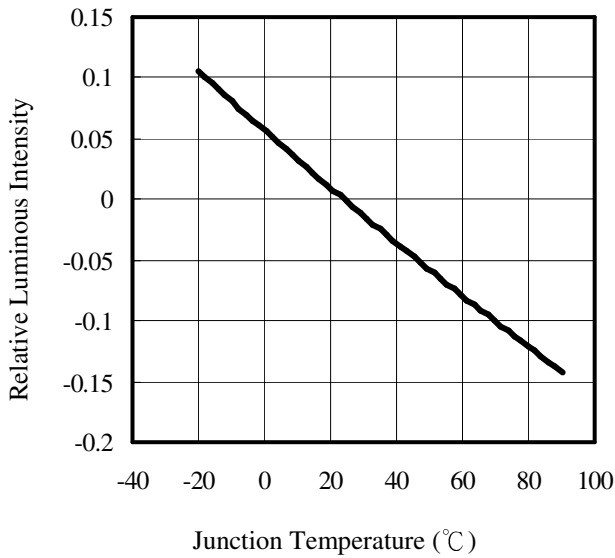

Note: $f(T_j) = I_v / I_v(25^\circ\text{C})$; $I_F = 30\text{mA}$

Relative Forward Voltage vs. Junction Temperature

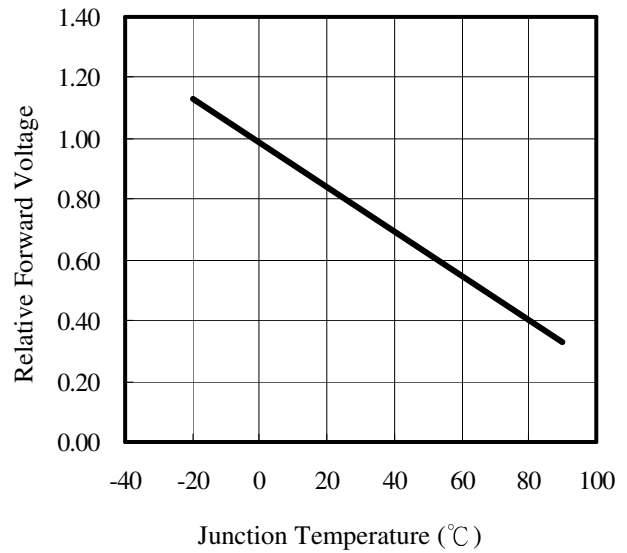

Note: $\Delta V_F = V_F - V_F(25^\circ\text{C}) = f(T_j)$; $I_F = 30\text{mA}$

Technical Data Sheet

Power Top LEDs

67-31EZ-BLT-2AV2ABC2F-2T8-AM

Package Dimension

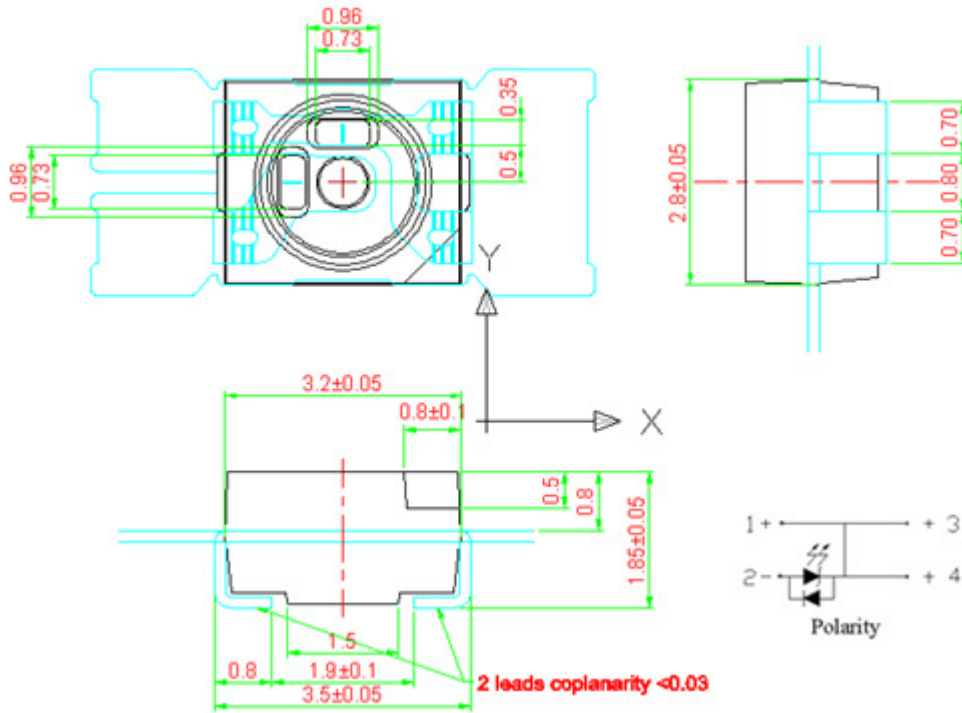

Note: Tolerances unless mentioned ± 0.1 mm. Unit = mm

Technical Data Sheet

Power Top LEDs

67-31EZ-BLT-2AV2ABC2F-2T8-AM

Carrier Tape Dimensions: Loaded Quantity 2000 pcs Per Reel

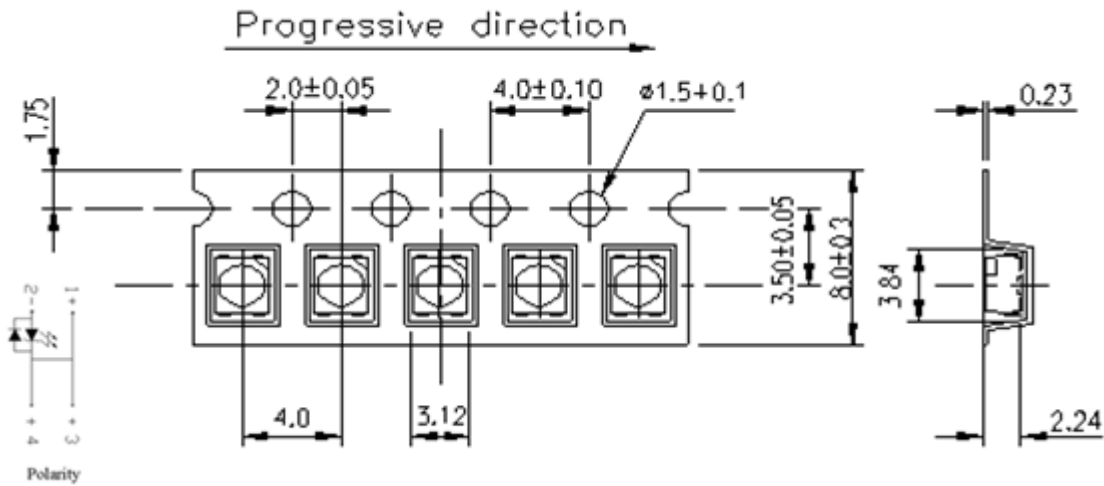

Note: Tolerances unless mentioned ± 0.1 mm. Unit = mm

Label Explanation

- CPN: Customer's Product Number
- P/N: Product Number
- QTY: Packing Quantity
- CAT: Luminous Intensity Rank
- HUE: Dom. Wavelength Rank
- REF: Forward Voltage Rank
- LOT No: Lot Number



Technical Data Sheet

Power Top LEDs

67-31EZ-BLT-2AV2ABC2F-2T8-AM

Reel Dimensions

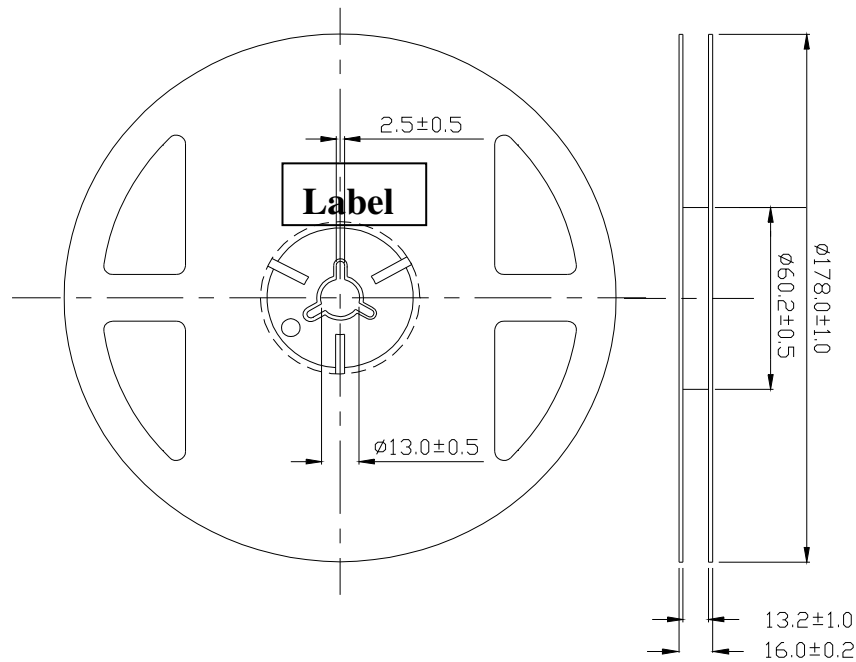

Note: Unit = mm

Moisture Resistant Packing Process

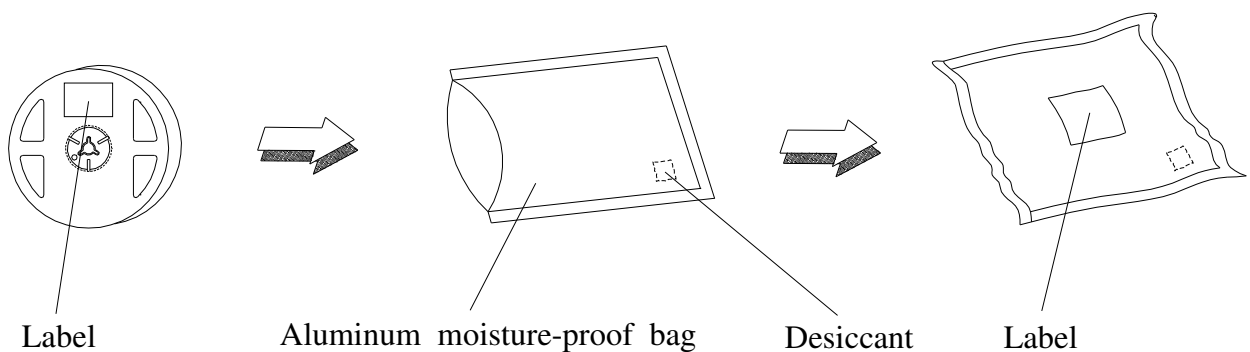

Technical Data Sheet

Power Top LEDs

67-31EZ-BLT-2AV2ABC2F-2T8-AM

Precautions for Use

1. Soldering Condition (Reference: IPC/JEDEC J-STD-020D)

a. IR reflow

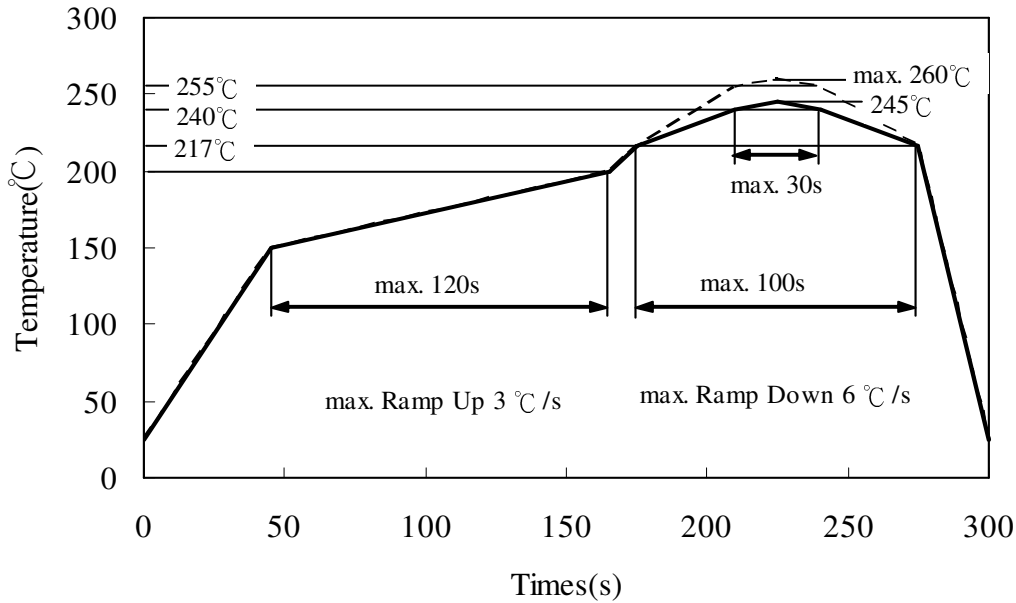

b. Wave soldering reflow

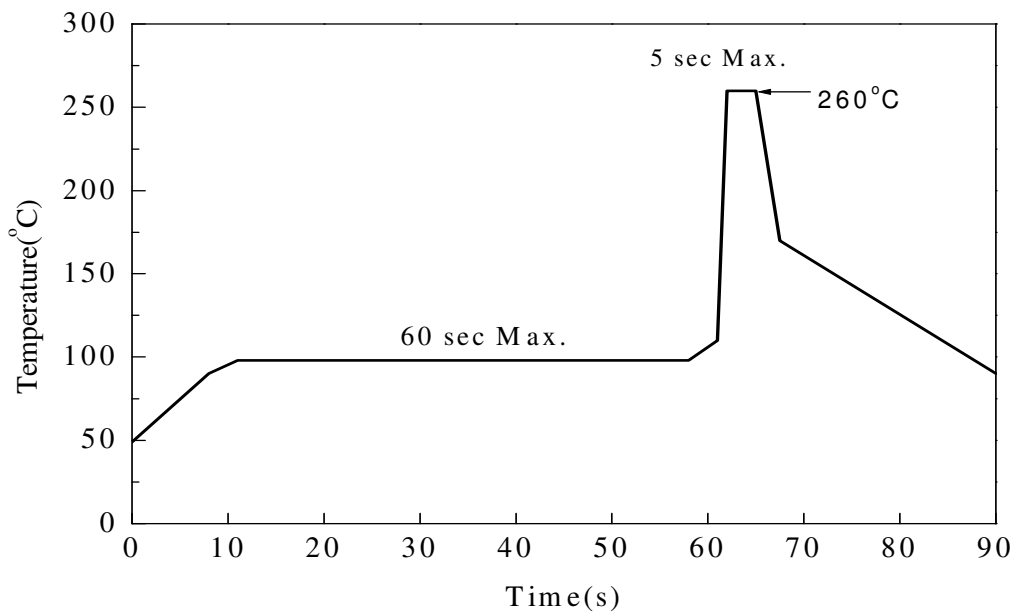

Technical Data Sheet

Power Top LEDs

67-31EZ-BLT-2AV2ABC2F-2T8-AM

(B) Recommend soldering pad

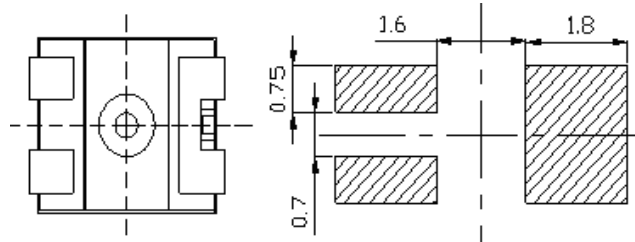

Note: Tolerances unless mentioned ± 0.1 mm. Unit = mm

2. Current limiting

A resistor should be used to limit current spikes that can be caused by voltage fluctuations. Otherwise damage could occur.

3. Storage

- 3.1 Moisture proof bag should only be opened immediately prior to usage.
- 3.2 Environment should be less than 30°C and 60% RH when moisture proof bag is opened.
- 3.3 After opening the package MSL Conditions stated on page 1 of this spec should not be exceeded.
- 3.4 If the moisture sensitivity card indicates higher than acceptable moisture, the component should be baked at min. 60°C $\pm 5^{\circ}\text{C}$ for 24 hours.

4. Iron Soldering

Hand soldering is not recommended for regular production. These guidelines are for rework only. Soldering iron tip should contact each terminal no more than 3 sec at 350°C , using soldering iron with nominal power less than 25W. Allow min. 2 sec. between soldering intervals.

5. Usage

Do not exceed the values given in this specification.

Application Restrictions

High reliability applications such as military/aerospace, automotive safety/security systems, and medical equipment may require different product. If you have any concerns, please contact Everlight before using this product in your application. This specification guarantees the quality and performance of the product as an individual component. Do not use this product beyond the specification described in this document.

Technical Data Sheet

Power Top LEDs

67-31EZ-BLT-2AV2ABC2F-2T8-AM

Revision History:

Rev.	Modified date	File modified contents
1	2009/12/4	New Spec
2	2010/03/30	變更為正式版本
3	2010/04/02	原 Package Dimension 錯誤，故更正
4	2010/07/05	客戶要求增加 VF 分 BIN
5	2010/12/3	更改 Emitted Color