

### SMD ■ Top View LEDs 67-11-RANC-Q6U1U2C1E-2T8-AM



#### Features

- P-LCC-2 package.
- Colorless clear resin.
- Wide viewing angle 120°.
- Inner reflector and white package.
- Brightness: 450 to 710 mcd at 20mA.
- Qualification according to AEC-Q101 rev C
- Precondition: Bases on JEDEC J-STD 020 Level 3.
- Automotive reflow profile (IR reflow or wave soldering)

#### Applications

- Automotive backlighting or indicator: Dashboard, switch, audio and video equipments...etc.
- Backlight: LCD, switches, symbol, mobile phone and illuminated advertising.
- Display for indoor and outdoor application.
- Ideal for coupling into light guides.
- Substitution of traditional light.
- Optical indicator.
- General applications.

## Device Selection Guide

Chip Materials	Emitted Color	Resin Color
AlGaInP	Super Red	Water Clear

## Absolute Maximum Ratings (Ta=25 °C)

Parameter	Symbol	Rating	Unit
Reverse Voltage	$V_R$	12	V
Forward Current	$I_F$	70	mA
Peak Forward Current (Duty 1/10 @1KHz)	$I_{FP}$	100	mA
Power Dissipation	$P_d$	120	mW
Junction Temperature	$T_j$	125	
Operating Temperature	$T_{opr}$	-40 ~ +100	
Storage Temperature	$T_{stg}$	-40 ~ +110	
Thermal Resistance	$R_{th\ J-A}$	250	K/W
	$R_{th\ J-S}$	150	K/W
ESD (Classification acc. AEC Q101)	$ESD_{HBM}$	2000	V
	$ESD_{MM}$	200	V
Soldering Temperature	$T_{sol}$	Reflow Soldering : 260 for 30 sec. Hand Soldering : 350 for 3 sec.	

**Electro-Optical Characteristics (Ta=25 °C)**

Parameter	Symbol	Min.	Typ.	Max.	Unit	Condition
Luminous Intensity	I <sub>v</sub>	450	---	710	mcd	I <sub>F</sub> =20mA
Viewing Angle	2θ <sub>1/2</sub>	---	120	---	deg	I <sub>F</sub> =20mA
Peak Wavelength	λ <sub>p</sub>	---	639	---	nm	I <sub>F</sub> =20mA
Dominant Wavelength	λ <sub>d</sub>	618	---	630	nm	I <sub>F</sub> =20mA
Spectrum Radiation Bandwidth	Δλ	---	20	---	nm	I <sub>F</sub> =20mA
Forward Voltage	V <sub>F</sub>	1.7	---	2.6	V	I <sub>F</sub> =20mA
Reverse Current	I <sub>R</sub>	---	---	10	μA	V <sub>R</sub> =12V

Note:

1. Tolerance of Luminous Intensity: ±11%
2. Tolerance of Dominant Wavelength: ±1nm
3. Tolerance of Forward Voltage: ±0.1V

**Bin Range of Luminous Intensity**

Bin Code	Min.	Max.	Unit	Condition
U1	450	560	mcd	I <sub>F</sub> =20mA
U2	560	710		

Note:

Tolerance of Luminous Intensity: ±11%

**Bin Range of Dominant Wavelength**

Bin Code	Min.	Max.	Unit	Condition
1	618	624	nm	I <sub>F</sub> =20mA
2	624	630		

## Note:

Tolerance of Dominant Wavelength: ±1nm

EVERLIGHT

**Typical Electro-Optical Characteristics Curves**

**Typical Curve of Spectral Distribution**

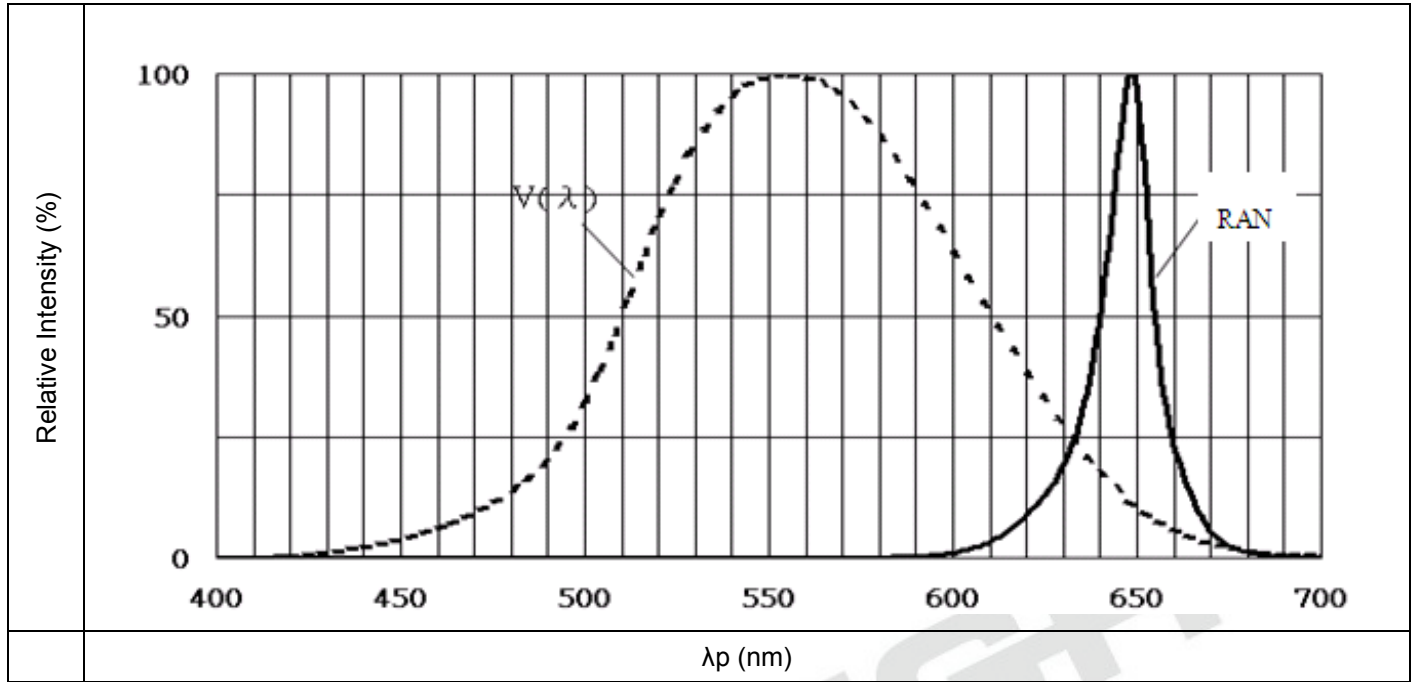

Note:  $V(\lambda)$ =Standard eye response curve;  $I_F = 20\text{mA}$

**Diagram Characteristics of Radiation**

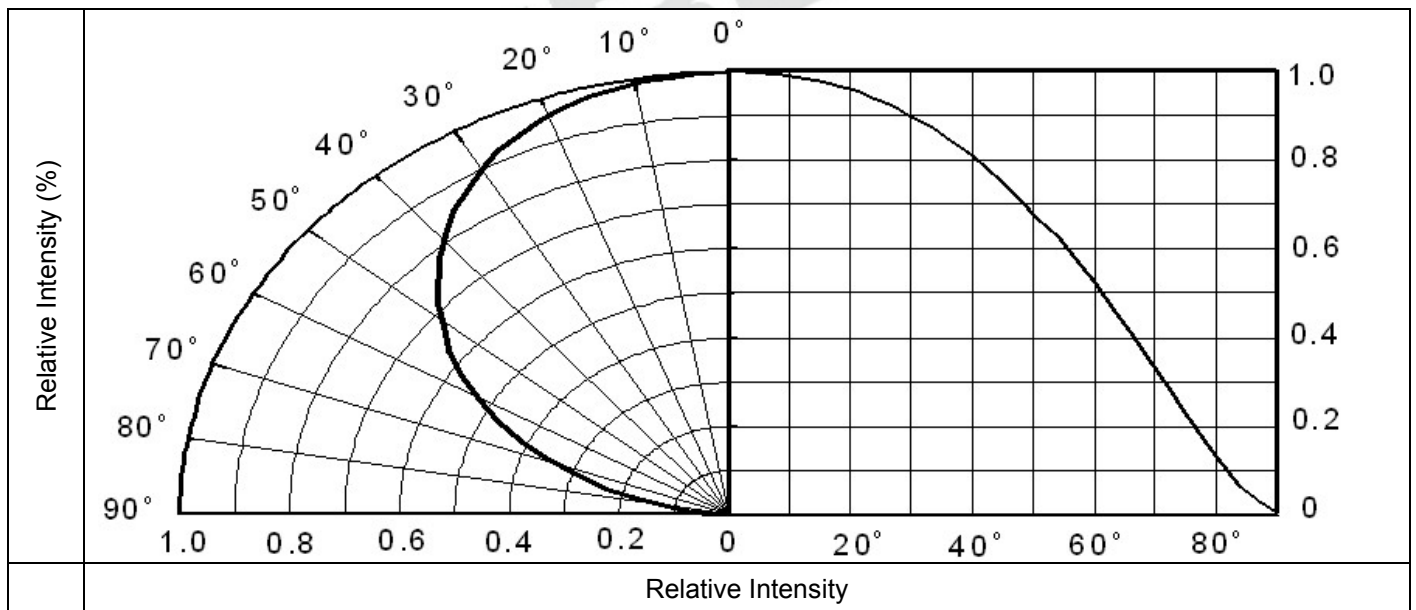

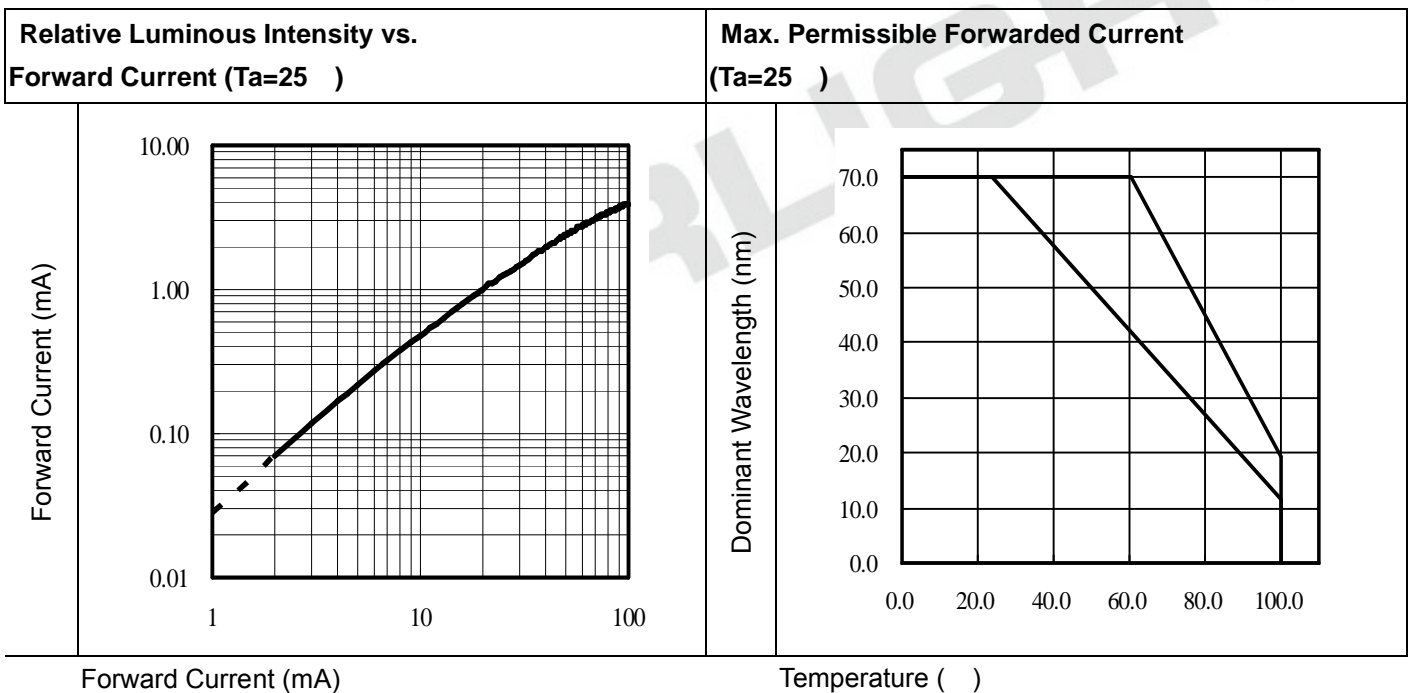
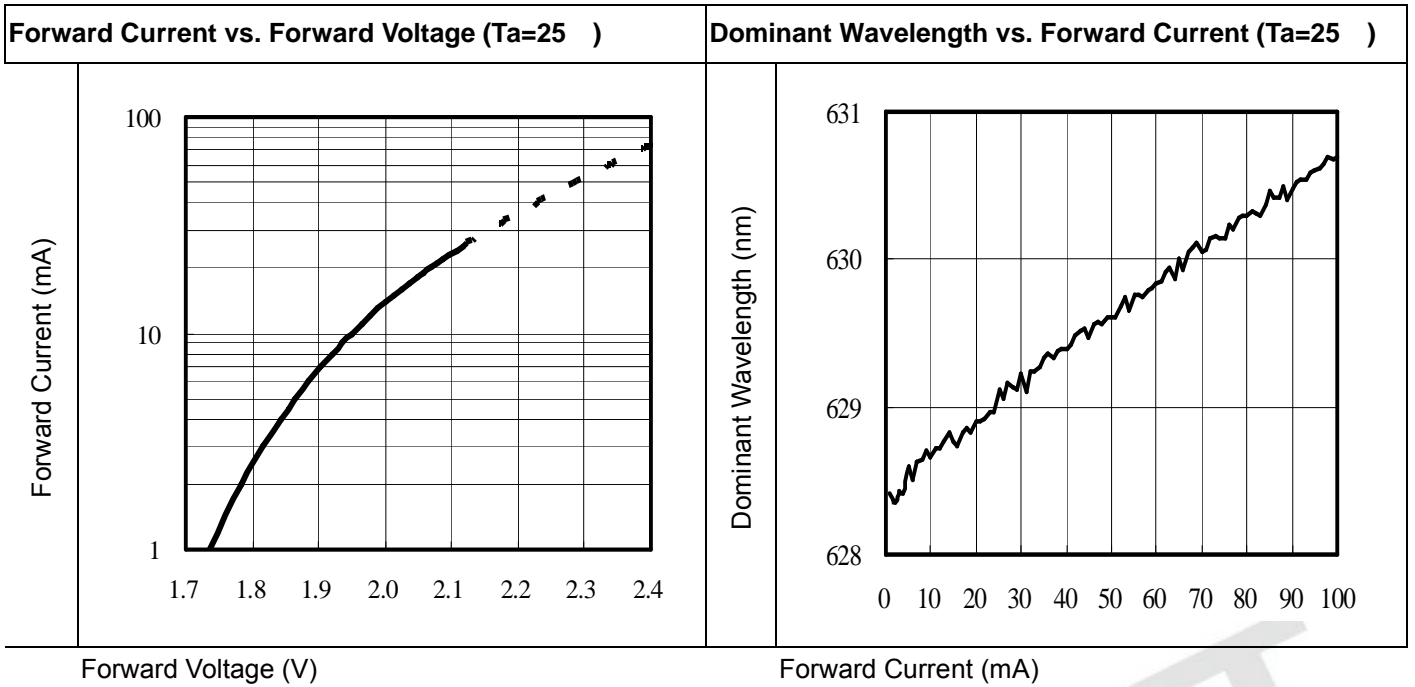

Package Dimension

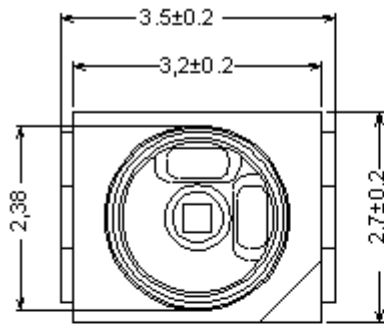

Chip position

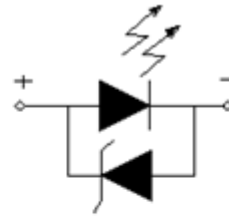

Polarity

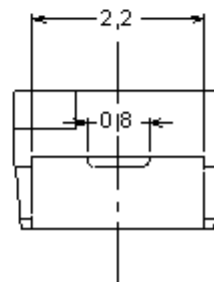
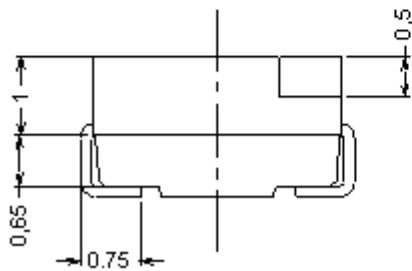

Note: Tolerances unless mentioned  $\pm 0.1$ mm. Unit = mm

**Moisture Resistant Packing Materials**

**Label Explanation**



- CPN: Customer's Product Number
- P/N: Product Number
- QTY: Packing Quantity
- CAT: Luminous Intensity Rank
- HUE: Dom. Wavelength Rank
- REF: Forward Voltage Rank
- LOT No: Lot Number

**Reel Dimensions**

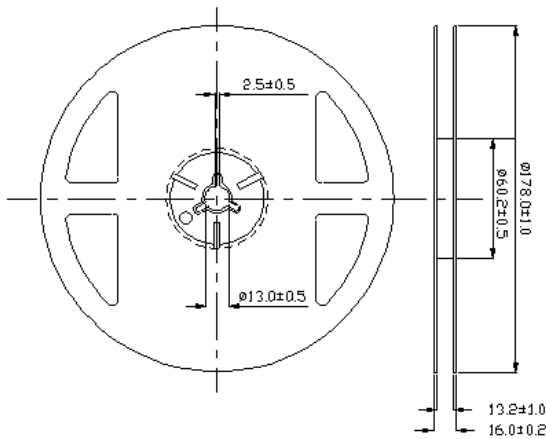

**Carrier Tape Dimensions: Loaded Quantity 2000 pcs Per Reel**

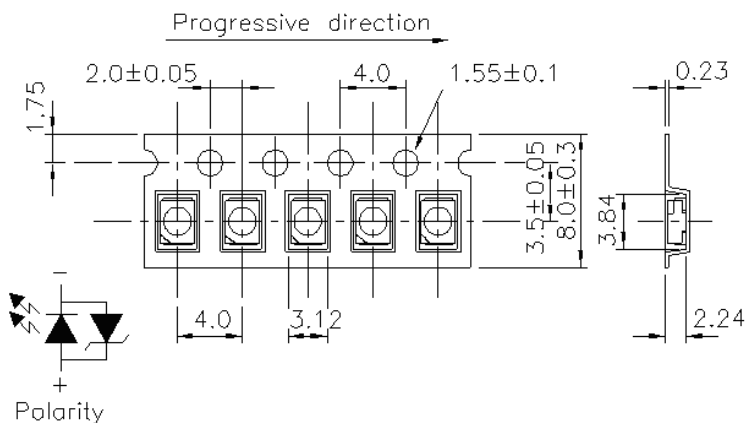

Note: Tolerances unless mentioned ±0.1mm. Unit = mm



**Moisture Resistant Packing Process**

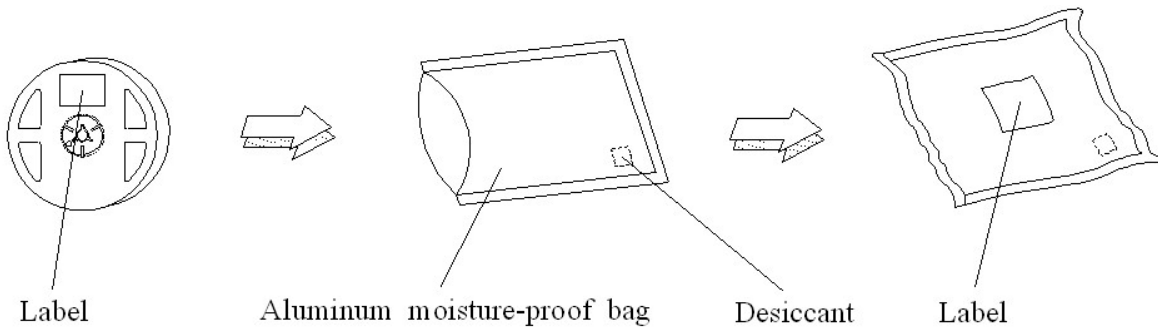

Note: Tolerances unless mentioned  $\pm 0.1\text{mm}$ . Unit = mm

**Precautions for Use**

**1. Soldering Condition (Reference: IPC/JEDEC J-STD-020D)**

**a. IR reflow**

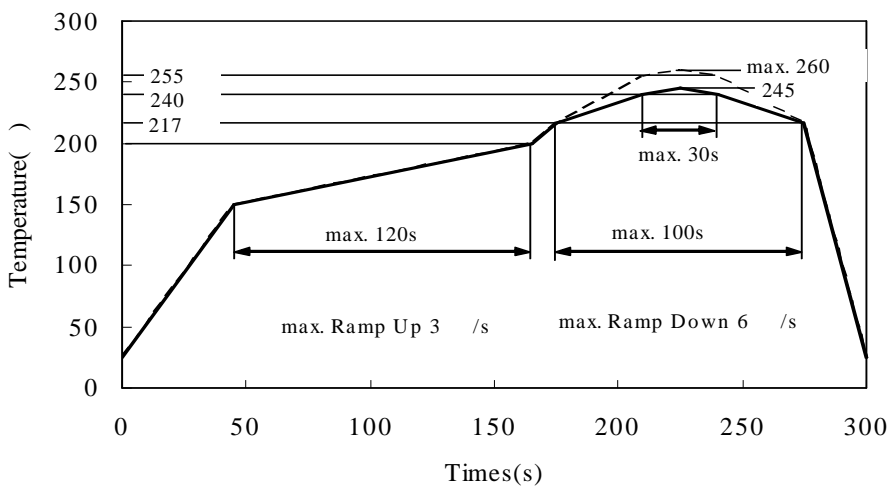

**b. Wave soldering reflow.**

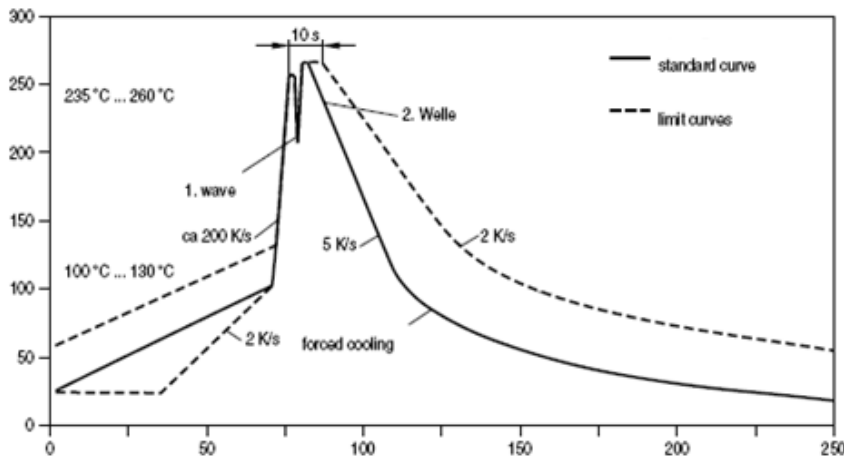

(B) Recommend soldering pad

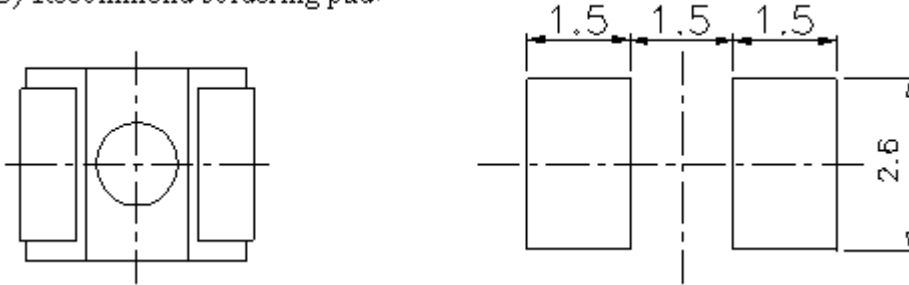

Note: Tolerances unless mentioned  $\pm 0.1$ mm. Unit = mm

## 2. Current limiting

A resistor should be used to limit current spikes that can be caused by voltage fluctuations. Otherwise damage could occur.

## 3. Storage

3.1 Moisture proof bag should only be opened immediately prior to usage.

3.2 Environment should be less than 30 °C and 60% RH when moisture proof bag is opened.

3.3 After opening the package MSL Conditions stated on page 1 of this spec should not be exceeded.

3.4 If the moisture sensitivity card indicates higher than acceptable moisture, the component should be baked at min. 60deg +/-5deg for 24 hours.

## 4. Iron Soldering

Hand soldering is not recommended for regular production. These guidelines are for rework only. Soldering iron tip should contact each terminal no more than 3 sec at 350 °C, using soldering iron with nominal power less than 25W. Allow min. 2 sec. between soldering intervals.

## 5. Usage

Do not exceed the values given in this specification.

## Application Restrictions

High reliability applications such as military/aerospace, automotive safety/security systems, and medical equipment may require different product. If you have any concerns, please contact Everlight before using this product in your application. This specification guarantees the quality and performance of the product as an individual component. Do not use this product beyond the specification described in this document.