



EVERLIGHT ELECTRONICS CO., LTD.

# DATA SHEET

Part No. : 61-03/GBB7RSW-B06/ET

Date : 2007.09.21

Department : RD3

Revision : 1.1

Received	
<input type="checkbox"/>	MASS PRODUCTION
<input checked="" type="checkbox"/>	PRELIMINARY
<input type="checkbox"/>	CUSTOMER DESIGN
PAGE : 14	

Revised record		
REV.	DESCRIPTION	RELEASE DATE
1.1	New Spec.	2007.9.21

OFFICE:..NO.25,LANE76,SEC.3,CHUNG YANG RD.,TUCHENG 236,TAIPEI,TAIWAN,R.O.C

TEL : 886-2-22672000

FAX : 886-2-22676244

<http://www.everlight.com>



## Technical Data Sheet - Preliminary

### Luminosity Full Color LED

**61-03/GBB7RSW-B06/ET**

#### Features

- White package with black surface.
- Optical indicator.
- Colorless clear window.
- Ideal for backlight and light pipe application.
- Interior reflector.
- Wide viewing angle.
- Suitable for vapor-phase reflow, infrared reflow and wave solder processes.
- Computable with automatic placement equipment.
- Pb-free.
- The product itself will remain within RoHS compliant version.

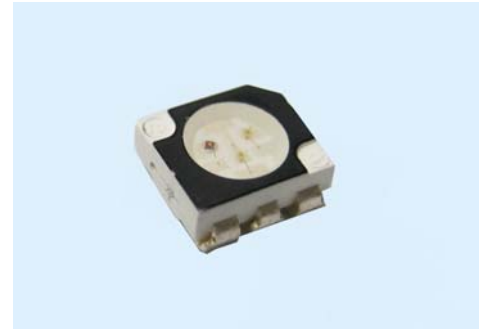

#### Descriptions

- Due to the package design, 61-03 has wide viewing angle , low power consumption and adjusting each color is possible thanks to serial connection by 6 terminal connection (Individual driving by each terminal) in case of using several number of LED. And makes it ideal for light pipe application.

#### Applications

- Amusement equipment.
- Information boards.
- Flashlight for digital camera of cellular phone.

#### Device Selection Guide

Chip		Emitted Color	Resin Color
Type	Material		
RS	AlGaInP	Brilliant Red	White Diffuse
GB	InGaN	Brilliant Green	
B7	InGaN	Blue	

Technical Data Sheet - Preliminary

Luminosity Full Color LED

**61-03/GBB7RSW-B06/ET**

Package Outline Dimensions

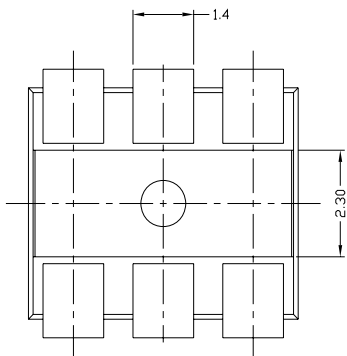
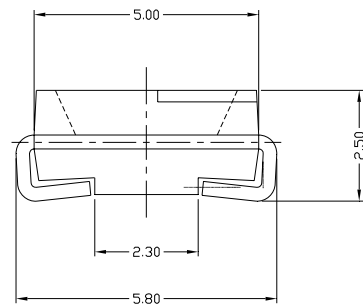
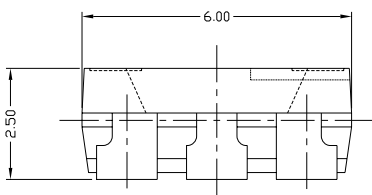
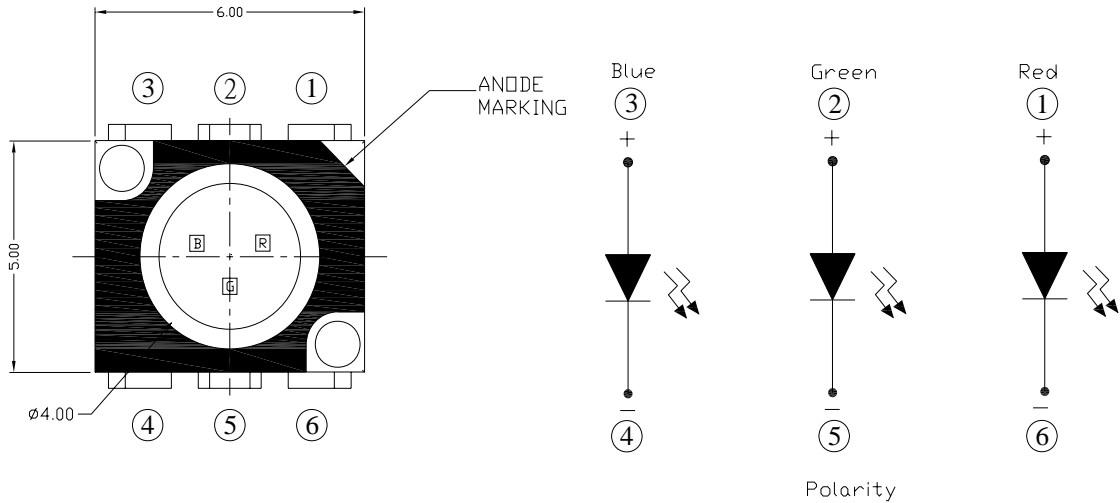

For Reflow Soldering (Proposal)

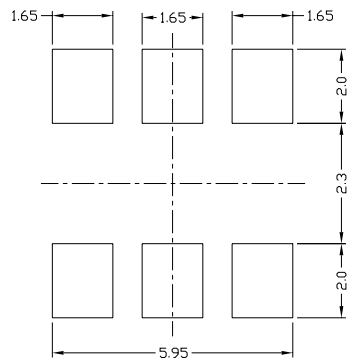

Notes:

1. All dimensions are in millimeters
2. Tolerance unless mentioned is  $\pm 0.1\text{mm}$

**Technical Data Sheet - Preliminary****Luminosity Full Color LED****61-03/GBB7RSW-B06/ET****Absolute Maximum Ratings (Ta=25°C)**

Parameter	Symbol	Rating		Unit
Reverse Voltage	$V_R$	5		V
Forward Current	$I_F$	RS	50	mA
		GB	30	
		B7	30	
Peak Forward Current (Duty 1/10 @ 1KHz)	$I_{FP}$	RS	100	mA
		GB	100	
		B7	100	
Power Dissipation	$P_d$	RS	120	mW
		GB	110	
		B7	110	
Electrostatic Discharge(HBM)	ESD	RS	2000	V
		GB	1000	
		B7	1000	
Operating Temperature	$T_{opr}$	-40 ~ +85		°C
Storage Temperature	$T_{stg}$	-40~ +90		°C
Soldering Temperature	$T_{sol}$	Reflow Soldering : 260 °C for 10 sec. Hand Soldering : 350 °C for 3 sec.		



## Technical Data Sheet - Preliminary

## Luminosity Full Color LED

**61-03/GBB7RSW-B06/ET**

## Electro-Optical Characteristics (Ta=25°C)

Parameter	Symbol	Min.	Typ.	Max.	Unit	Condition	
Luminous Intensity	I <sub>v</sub>	RS	500	-----	720	mcd	I <sub>F</sub> =20mA
		GB	1030	-----	1485		
		B7	345	-----	500		
Peak Wavelength	λ <sub>p</sub>	RS	-----	632	-----	nm	I <sub>F</sub> =20mA
		GB	-----	518	-----		
		B7	-----	468	-----		
Dominant Wavelength	λ <sub>d</sub>	RS	619	-----	628	nm	I <sub>F</sub> =20mA
		GB	525	-----	532.5		
		B7	465	-----	472.5		
Spectrum Radiation Bandwidth	Δλ	RS	-----	20	-----	nm	I <sub>F</sub> =20mA
		GB	-----	35	-----		
		B7	-----	35	-----		
Forward Voltage	V <sub>F</sub>	RS	1.75	-----	2.35	V	I <sub>F</sub> =20mA
		GB	2.9	-----	3.5		
		B7	2.9	-----	3.5		
Viewing Angle	2θ <sub>1/2</sub>	-----	120	-----	deg	I <sub>F</sub> =20mA	
Reverse Current	I <sub>R</sub>	RS	-----	-----	10	μA	V <sub>R</sub> =5V
		GB	-----	-----	50		
		B7	-----	-----	50		

**Note:**

1. Tolerance of Luminous Intensity: ±11%
2. Tolerance of Dominant Wavelength: ±1nm
3. Tolerance of Forward Voltage: ±11%



## Technical Data Sheet - Preliminary

## Luminosity Full Color LED

**61-03/GBB7RSW-B06/ET****Bin Range of Luminous Intensity**

Symbol		Bin Code	Min.	Max.	Unit	Condition
I <sub>v</sub>	RS	11	500	600	mcd	I <sub>F</sub> = 20mA
		12	600	720		
	GB	15	1030	1240		
		16	1240	1485		
	B7	9	345	415		
		10	415	500		

**Bin Range of Dominant Wavelength**

Symbol		Bin Code	Min.	Max.	Unit	Condition
λ <sub>d</sub>	RS	R1	619	622	nm	I <sub>F</sub> = 20mA
		R2	622	625		
		R3	625	628		
	GB	G1	525	527.5		
		G2	527.5	530		
		G3	530	532.5		
	B7	B1	465	467.5		
		B2	467.5	470		
		B3	470	472.5		

**Note:**

1. Tolerance of Luminous Intensity: ±11%
2. Tolerance of Dominant Wavelength: ±1nm



## Technical Data Sheet - Preliminary

## Luminosity Full Color LED

**61-03/GBB7RSW-B06/ET**

## Bin Range of Forward Voltage

Symbol		Bin Code	Min.	Max.	Unit	Condition
V <sub>F</sub>	RS	0	1.75	1.95	V	I <sub>F</sub> = 20mA
		1	1.95	2.15		
		2	2.15	2.35		
	GB	11	2.90	3.10		
		12	3.10	3.30		
		13	3.30	3.50		
	B7	11	2.90	3.10		
		12	3.10	3.30		
		13	3.30	3.50		

## Note:

1. Tolerance of Forward Voltage:  $\pm 11\%$



Technical Data Sheet - Preliminary

Luminosity Full Color LED

61-03/GBB7RSW-B06/ET

Typical Electro-Optical Characteristics Curves (GB)

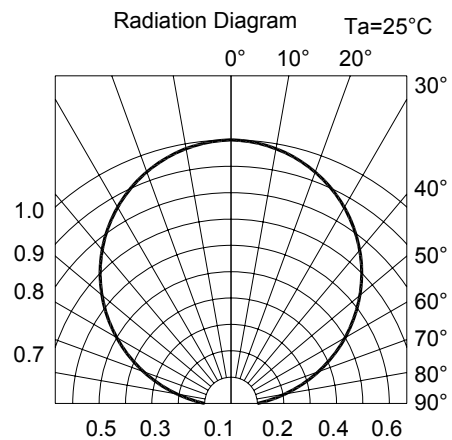
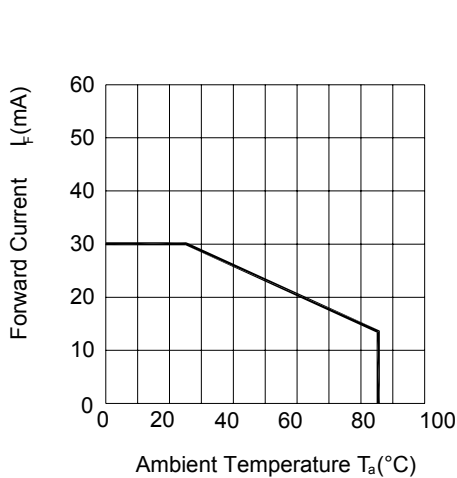
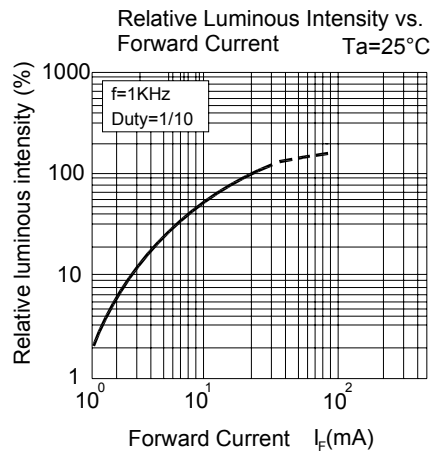
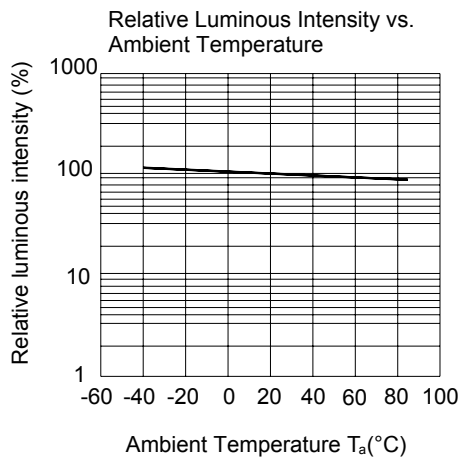
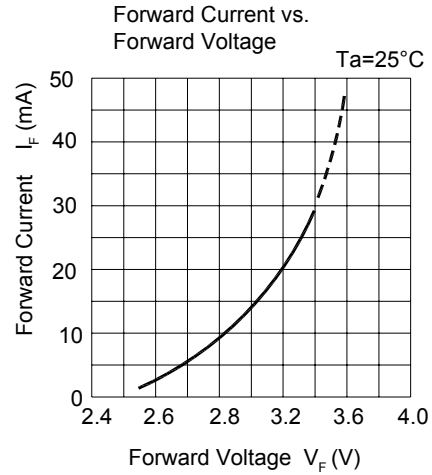
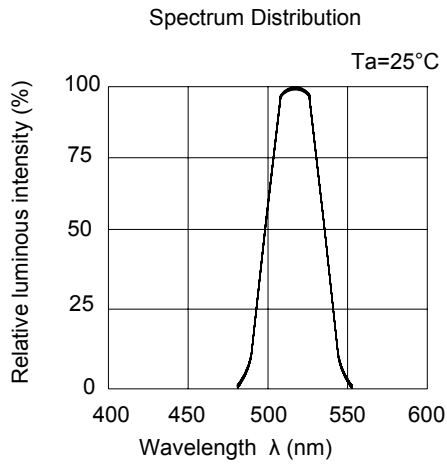



Technical Data Sheet - Preliminary

Luminosity Full Color LED

**61-03/GBB7RSW-B06/ET**

Typical Electro-Optical Characteristics Curves (B7)

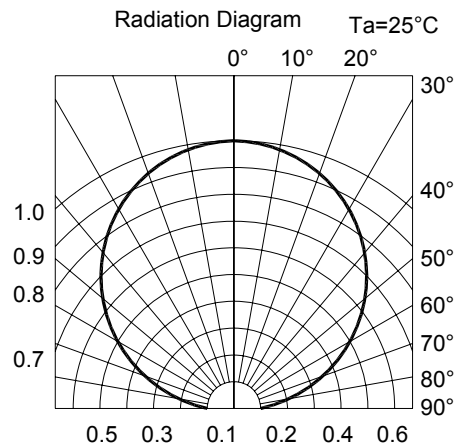
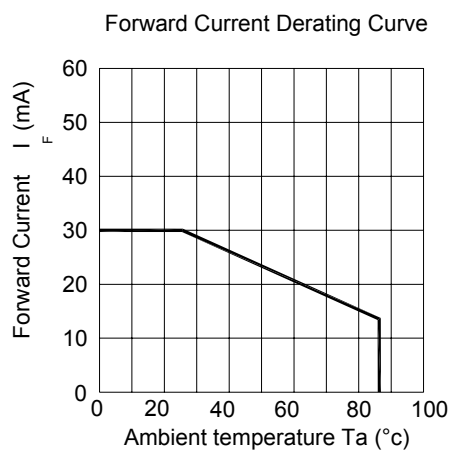
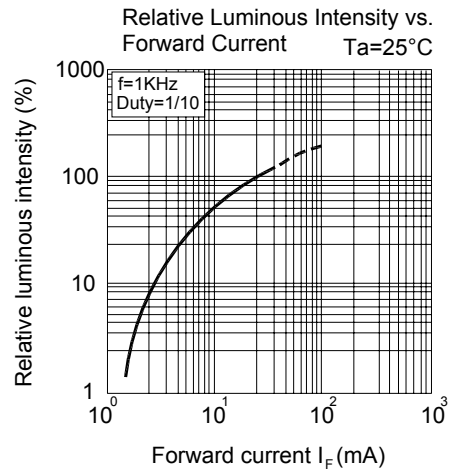
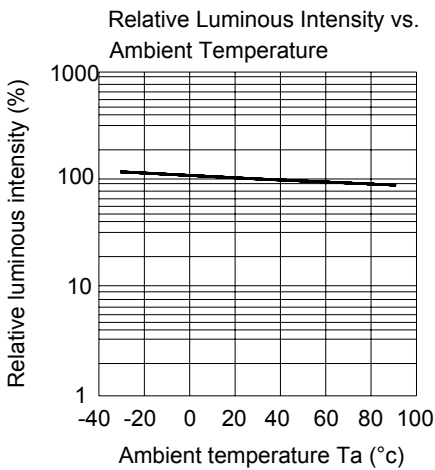
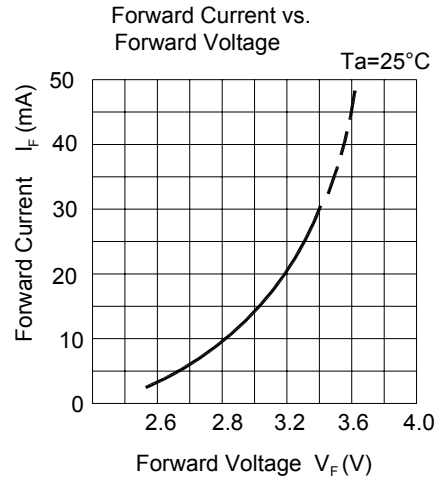
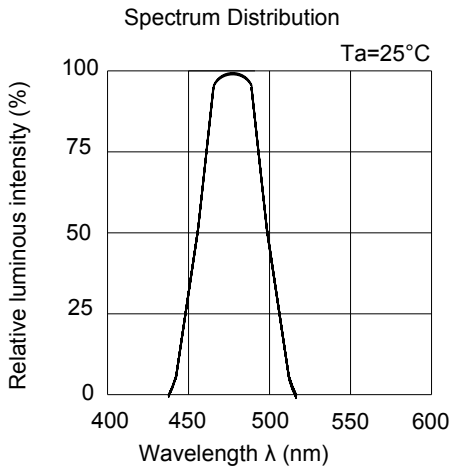

Technical Data Sheet - Preliminary

Luminosity Full Color LED

**61-03/GBB7RSW-B06/ET**

Typical Electro-Optical Characteristics Curves (RS)

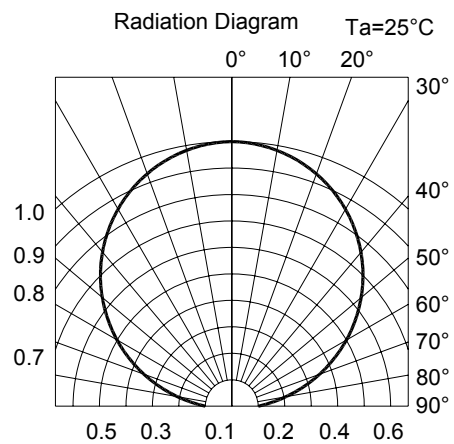
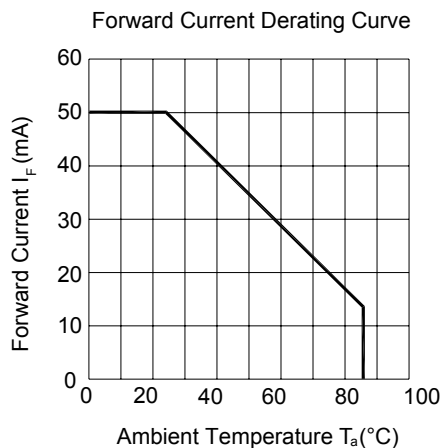
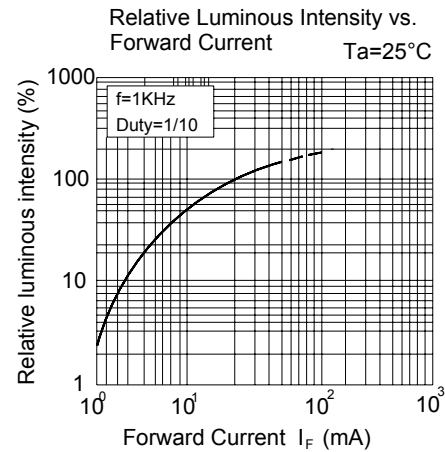
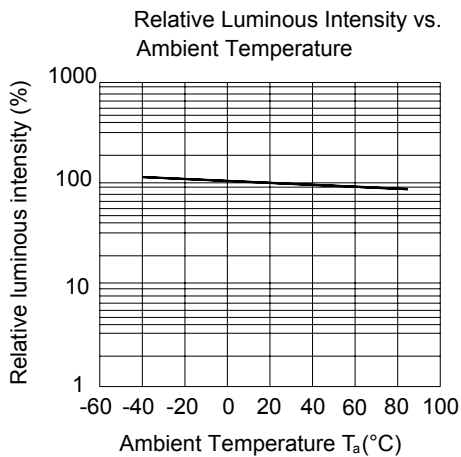
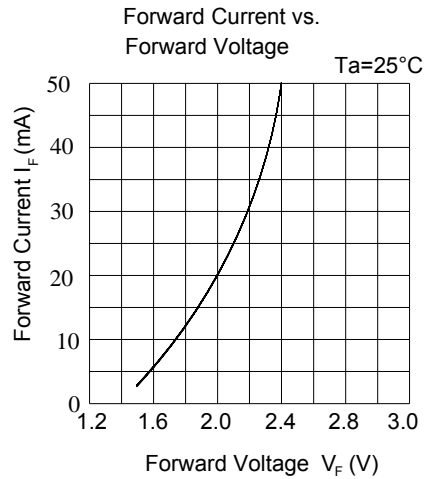
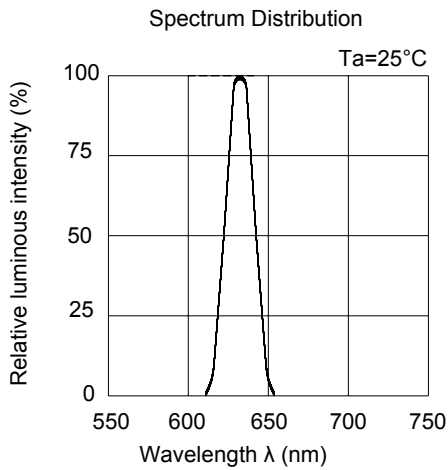



Technical Data Sheet - Preliminary

Luminosity Full Color LED

61-03/GBB7RSW-B06/ET

Label Explanation

CAT: Luminous Intensity Rank

HUE: Dom. Wavelength Rank

REF: Forward Voltage Rank

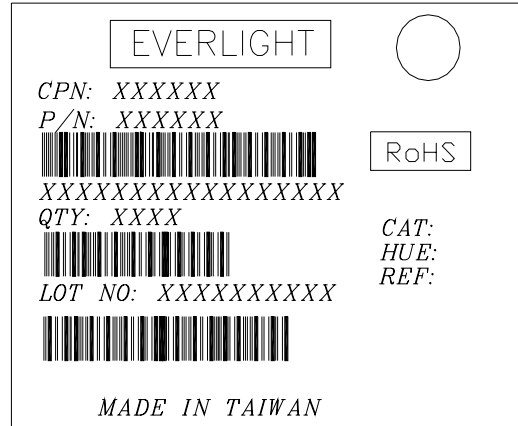

Reel Dimensions

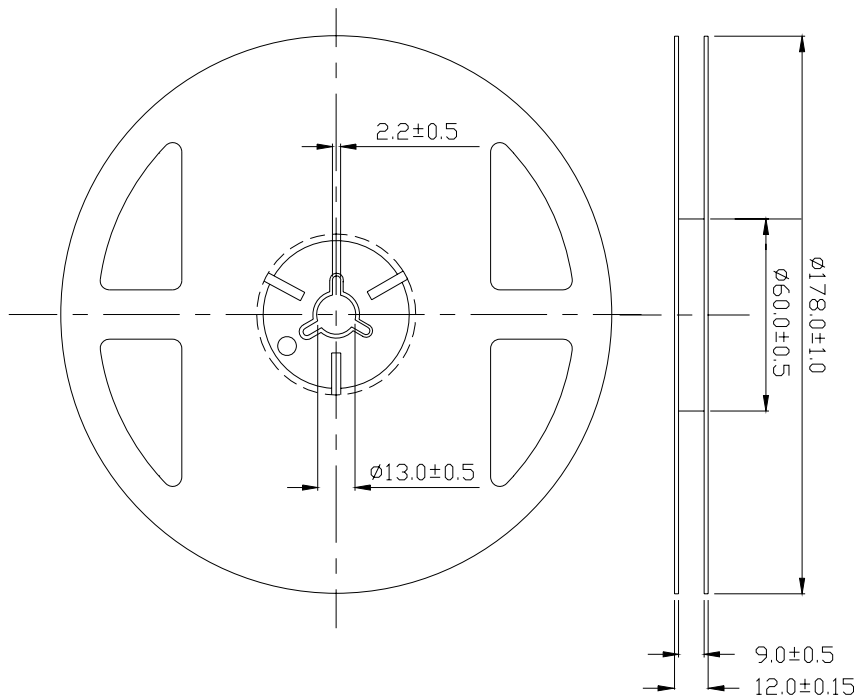

Note: Tolerance unless mentioned is ±0.1mm; Unit = mm



Technical Data Sheet - Preliminary

Luminosity Full Color LED

**61-03/GBB7RSW-B06/ET**

Carrier Tape Dimensions: Loaded Quantity 800 pcs Per Reel

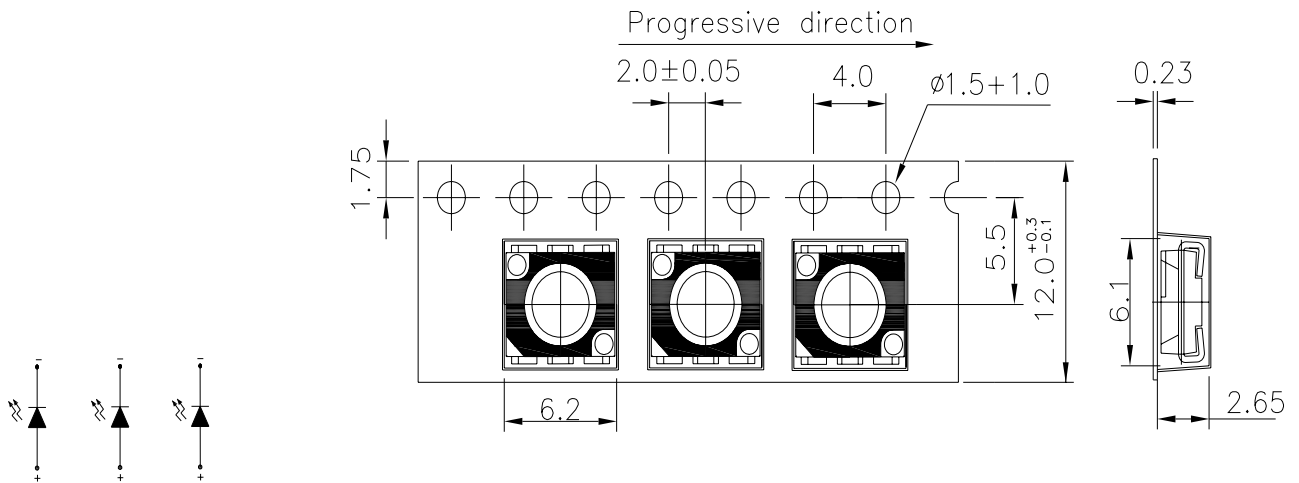

**Note:** The tolerances unless mentioned is  $\pm 0.1$ mm; Unit = mm

Moisture Resistant Packaging

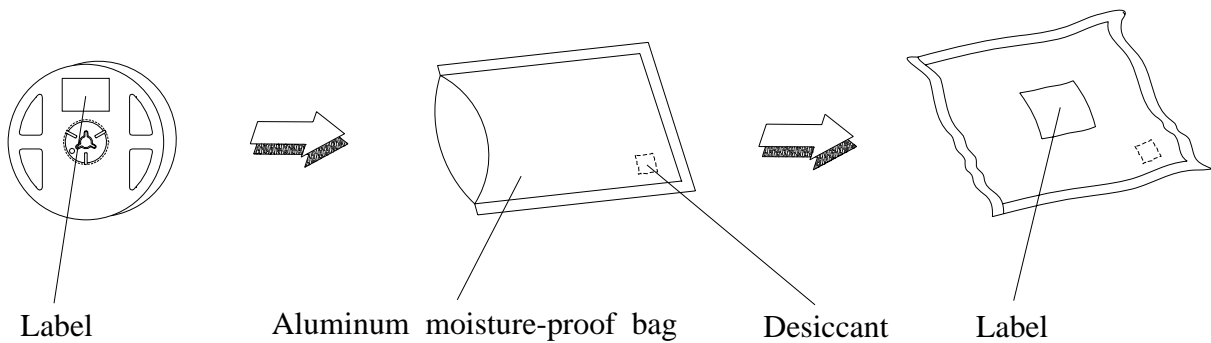

**Technical Data Sheet - Preliminary****Luminosity Full Color LED****61-03/GBB7RSW-B06/ET****Reliability Test Items and Conditions**

The reliability of products shall be satisfied with items listed below.

Confidence level : 90%

LTPD : 10%

No.	Items	Test Condition	Test Hours/Cycles	Sample Size	Ac/Re
1	Reflow Soldering	Temp. : 260°C±5°C Min. 5sec.	6 Min.	22 PCS.	0/1
2	Temperature Cycle	H : +100°C 15min ∫ 5 min L : -40°C 15min	300 Cycles	22 PCS.	0/1
3	Thermal Shock	H : +100°C 5min ∫ 10 sec L : -10°C 5min	300 Cycles	22 PCS.	0/1
4	High Temperature Storage	Temp. : 100°C	1000 Hrs.	22 PCS.	0/1
5	Low Temperature Storage	Temp. : -40°C	1000 Hrs.	22 PCS.	0/1
6	DC Operating Life	I <sub>F</sub> = 20 mA	1000 Hrs.	22 PCS.	0/1
7	High Temperature / High Humidity	85°C / 85%RH	1000 Hrs.	22 PCS.	0/1

**Technical Data Sheet - Preliminary****Luminosity Full Color LED****61-03/GBB7RSW-B06/ET****Precautions for Use**

## 1. Over-current-proof

Customer must apply resistors for protection; otherwise slight voltage shift will cause big current change (Burn out will happen).

## 2. Storage

2.1 Do not open moisture proof bag before the products are ready to use.

2.2 Before opening the package: The LEDs should be kept at 30°C or less and 90%RH or less.

2.3 After opening the package: The LED's floor life is 1 year under 30°C or less and 60% RH or less. If unused LEDs remain, it should be stored in moisture proof packages.

2.4 If the moisture absorbent material (silica gel) has faded away or the LEDs have exceeded the storage time, baking treatment should be performed using the following conditions.

Baking treatment: 60±5°C for 24 hours.

## 3. Soldering Condition

## 3.1 Pb-free solder temperature profile

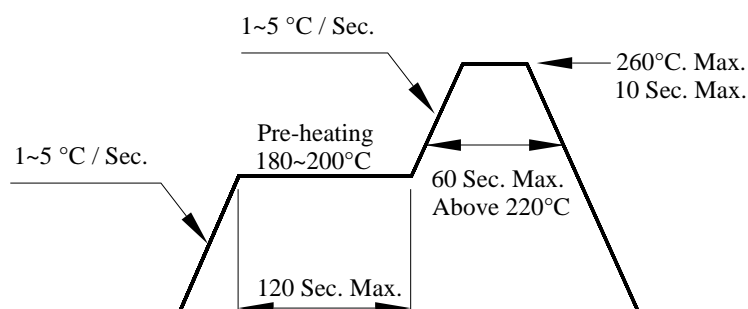

3.2 Reflow soldering should not be done more than two times.

3.3 When soldering, do not put stress on the LEDs during heating.

3.4 After soldering, do not warp the circuit board.

**Technical Data Sheet - Preliminary****Luminosity Full Color LED****61-03/GBB7RSW-B06/ET****4. Soldering Iron**

Each terminal is to go to the tip of soldering iron temperature less than 350°C for 3 seconds within once in less than the soldering iron capacity 25W. Leave two seconds and more intervals, and do soldering of each terminal. Be careful because the damage of the product is often started at the time of the hand solder.

**5. Repairing**

Repair should not be done after the LEDs have been soldered. When repairing is unavoidable, a double-head soldering iron should be used (as below figure). It should be confirmed beforehand whether the characteristics of the LEDs will or will not be damaged by repairing.

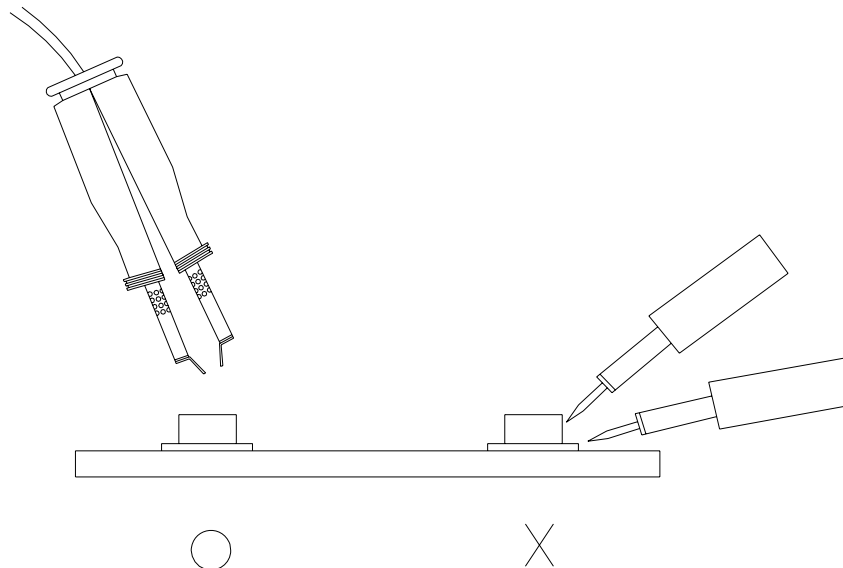

**EVERLIGHT ELECTRONICS CO., LTD.**  
Office: No 25, Lane 76, Sec 3, Chung Yang Rd,  
Tucheng, Taipei 236, Taiwan, R.O.C

Tel: 886-2-2267-2000, 2267-9936  
Fax: 886-2267-6244, 2267-6189, 2267-6306  
<http://www.everlight.com>