

## Technical Data Sheet

### Side View LEDs

**57-21-GPSC-U8M1N2A5E-BT8-AM**

#### Lead (Pb) Free Product - RoHS Compliant



#### Feature

- P-LCC-4 package.
- Colorless clear resin.
- Wide viewing angle 120°.
- Inner reflector and white package.
- Brightness: 18 to 45 mcd at 20mA.
- Precondition: Bases on JEDEC J-STD 020D Level 3.
- Qualification according to AEC-Q101 rev C.
- Automotive reflow profile (IR reflow or wave soldering)

#### Applications

- Automotive backlighting or indicator: Dashboard, LCD, signal switch, keys, display, symbol luminaire, audio and video equipments...etc.
- Backlight: LCD, switches, symbol, mobile phone and illuminated advertising.
- Display for indoor and outdoor application.
- Ideal for coupling into light guides.
- Substitution of traditional light.
- Optical indicator.
- General applications.

#### Device Selection Guide

Chip	Emitted Color	Resin Color
Material		
AlGaInP	Pale Green	Water Clear

Technical Data Sheet

Side View LEDs

**57-21-GPSC-U8M1N2A5E-BT8-AM**

Absolute Maximum Ratings (Ta=25 )

Parameter	Symbol	Rating	Unit
Reverse Voltage	V <sub>R</sub>	12	V
Forward Current	I <sub>F</sub>	30	mA
Peak Forward Current (Duty 1/10 @1KHz)	I <sub>FP</sub>	100	mA
Power Dissipation	P <sub>d</sub>	120	mW
Junction Temperature	T <sub>j</sub>	125	
Operating Temperature	T <sub>opr</sub>	-40 ~ +100	
Storage Temperature	T <sub>stg</sub>	-40 ~ +110	
Thermal resistance	R <sub>th J-A</sub>	500	K/W
	R <sub>th J-S</sub>	300	K/W
ESD (Classification acc. AEC Q101)	ESD <sub>HBM</sub>	2000	V
	ESD <sub>MM</sub>	200	V
Soldering Temperature	T <sub>sol</sub>	Reflow Soldering : 260 Hand Soldering : 350	for 30 sec. for 3 sec.

Technical Data Sheet

Side View LEDs

**57-21-GPSC-U8M1N2A5E-BT8-AM**

Electro-Optical Characteristics (Ta=25 )

Parameter	Symbol	Min.	Typ.	Max.	Unit	Condition
Luminous Intensity	$I_v$	18	---	45	mcd	$I_F = 20\text{mA}$
Viewing Angle	$2\theta_{1/2}$	---	120	---	deg	$I_F = 20\text{mA}$
Peak Wavelength	$\lambda_p$	---	561	---	nm	$I_F = 20\text{mA}$
Dominant Wavelength	$\lambda_d$	559	---	568	nm	$I_F = 20\text{mA}$
Spectrum Radiation Bandwidth	$\Delta\lambda$	---	20	---	nm	$I_F = 20\text{mA}$
Forward Voltage	$V_F$	1.8	---	2.4	V	$I_F = 20\text{mA}$
Reverse Current	$I_R$	---	---	10	$\mu\text{A}$	$V_R = 12\text{V}$
Temperature coefficient of $\lambda_p$	$TC_{\lambda_p}$	---	0.11	---	nm/K	$I_F = 20\text{mA}$
Temperature coefficient of $\lambda_d$	$TC_{\lambda_d}$	---	0.09	---	nm/K	$I_F = 20\text{mA}$
Temperature coefficient of $V_F$	$TC_V$	---	-2.1	---	mV/K	$I_F = 20\text{mA}$

Note:

1. Tolerance of Luminous Intensity:  $\pm 11\%$
2. Tolerance of Dominant Wavelength:  $\pm 1\text{nm}$
3. Tolerance of Forward Voltage:  $\pm 0.1\text{V}$

**Technical Data Sheet**  
**Side View LEDs**

**57-21-GPSC-U8M1N2A5E-BT8-AM**

**Bin Range of Luminous Intensity**

Bin Code	Min.	Max.	Unit	Condition
M1	18	22.4	mcd	I <sub>F</sub> =20mA
M2	22.4	28		
N1	28	35.5		
N2	35.5	45		

Notes : Tolerance of Luminous Intensity : ±11%

**Bin Range of Dominant Wavelength**

Bin Code	Min.	Max.	Unit	Condition
1	559	562	nm	I <sub>F</sub> =20mA
2	562	565		
3	565	568		

Notes : Tolerance of Dominant Wavelength : ±1nm

CONFIDENTIAL

**Technical Data Sheet**

**Side View LEDs**

**57-21-GPSC-U8M1N2A5E-BT8-AM**

**Typical Electro-Optical Characteristics Curves**

**Typical Curve of Spectral Distribution**

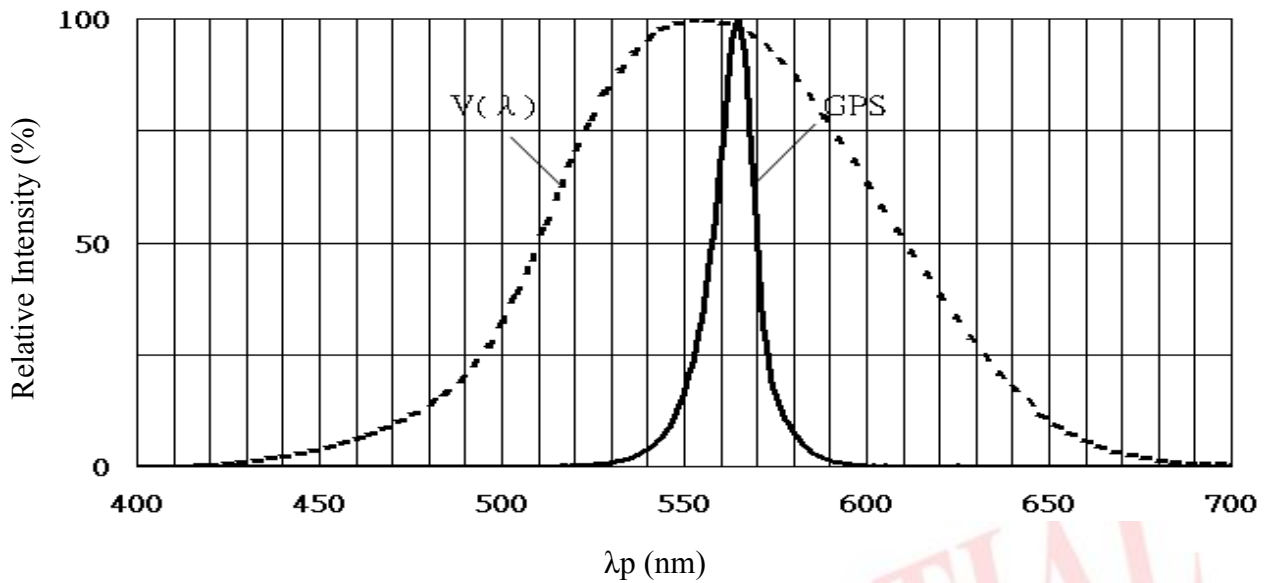

Note:  $V(\lambda)$ =Standard eye response curve

**Diagram Characteristics of Radiation**

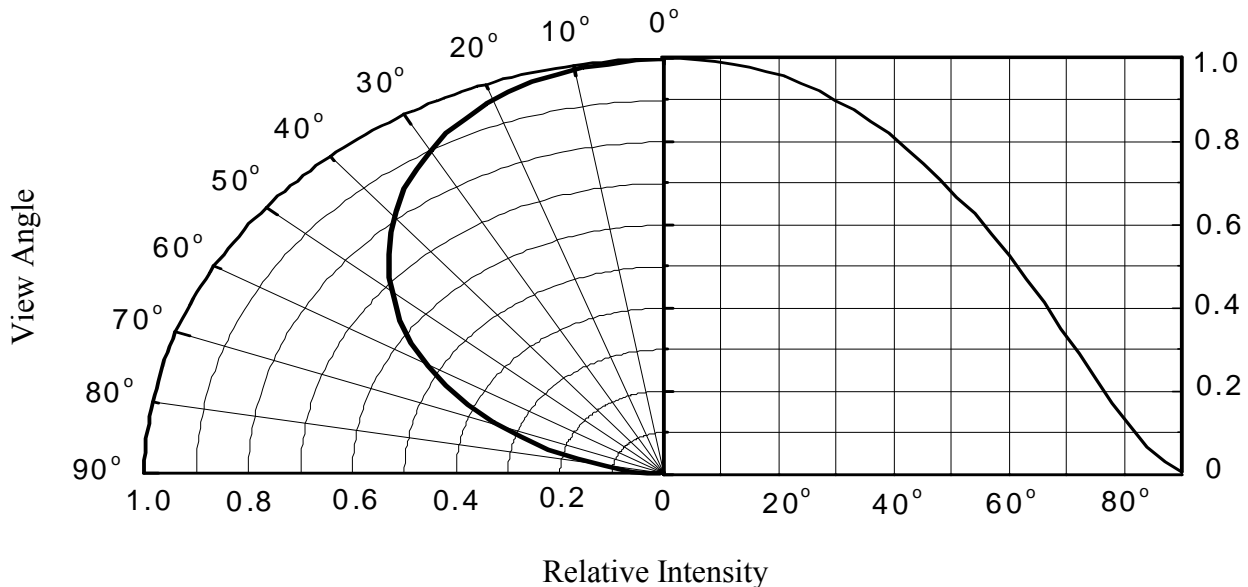

**Technical Data Sheet**  
**Side View LEDs**

**57-21-GPSC-U8M1N2A5E-BT8-AM**

**Forward Current vs. Forward Voltage**  
( $T_a=25^\circ\text{C}$ )

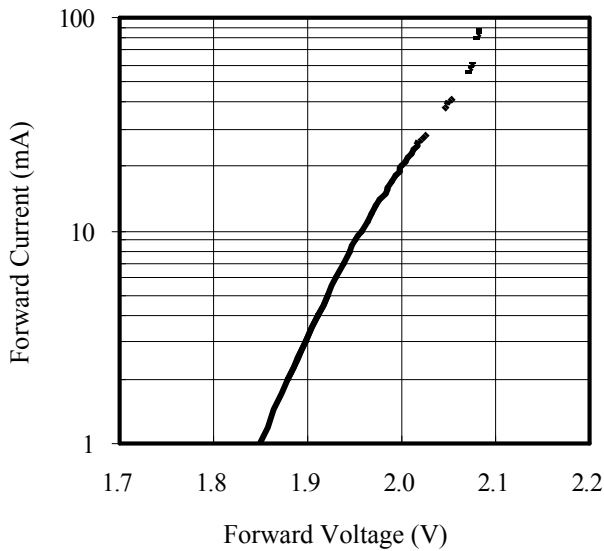

**Dominant Wavelength vs. Forward Current**  
( $T_a=25^\circ\text{C}$ )

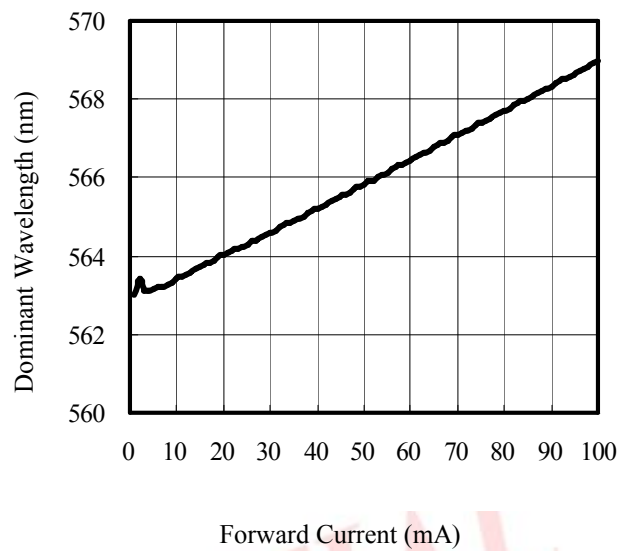

**Relative Luminous Intensity vs. Forward Current**  
( $T_a=25^\circ\text{C}$ )

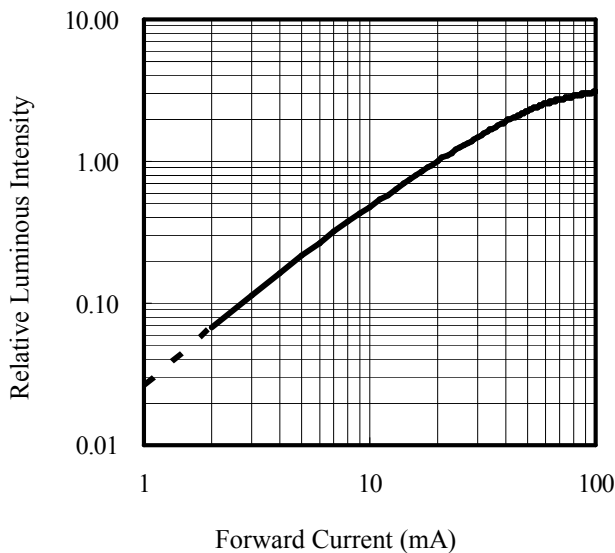

**Forward current vs. Ambient and Solder Temperature**

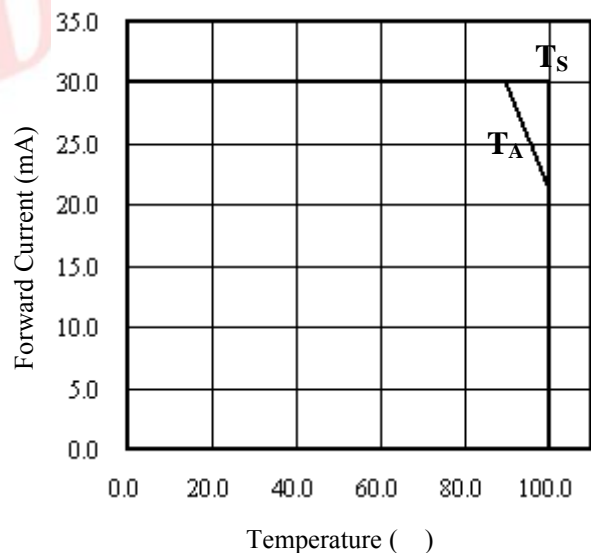

**Technical Data Sheet**

**Side View LEDs**

**57-21-GPSC-U8M1N2A5E-BT8-AM**

**Relative Luminous Intensity vs. Junction Temperature**

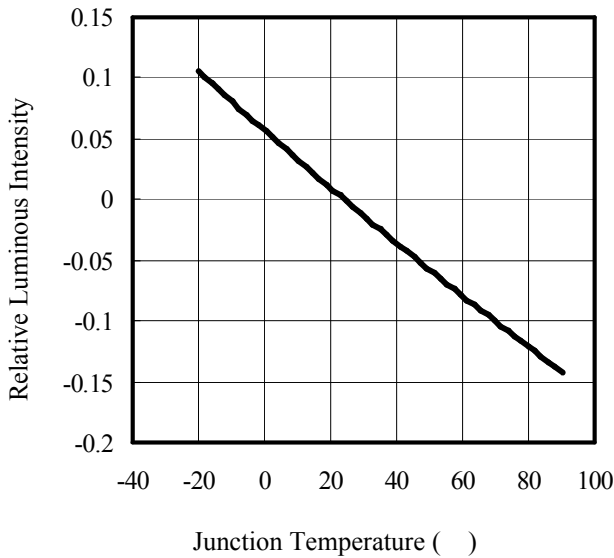

Note:  $f(T_j) = I_v / I_v(25^\circ\text{C})$ ;  $I_F = 20\text{mA}$

**Relative Forward Voltage vs. Junction Temperature**

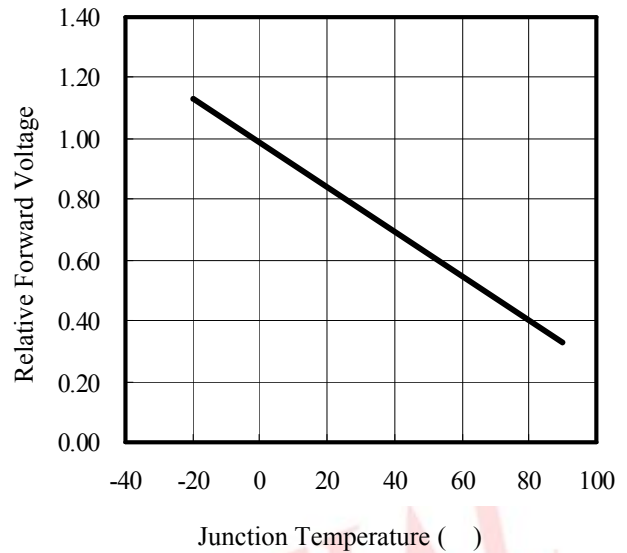

Note:  $V_F = V_F - V_F(25^\circ\text{C}) = f(T_j)$ ;  $I_F = 20\text{mA}$

CONFIDENTIAL

# Technical Data Sheet

## Side View LEDs

**57-21-GPSC-U8M1N2A5E-BT8-AM**

### Package Dimension

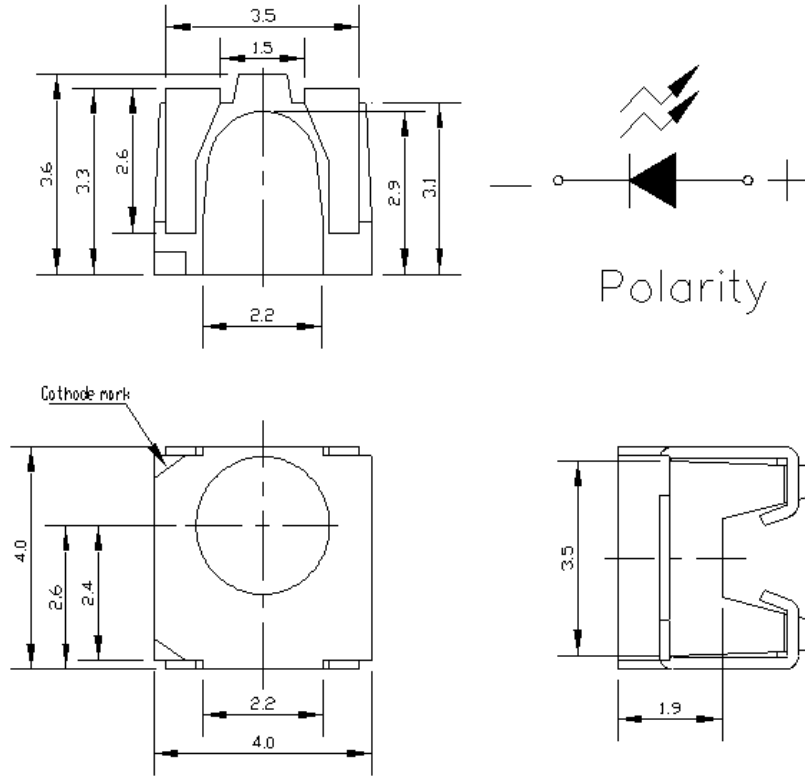

Note: Tolerances unless mentioned  $\pm 0.1$ mm. Unit = mm



**Technical Data Sheet**  
**Side View LEDs**

**57-21-GPSC-U8M1N2A5E-BT8-AM**

Carrier Tape Dimensions: Loaded Quantity 500 pcs Per Reel

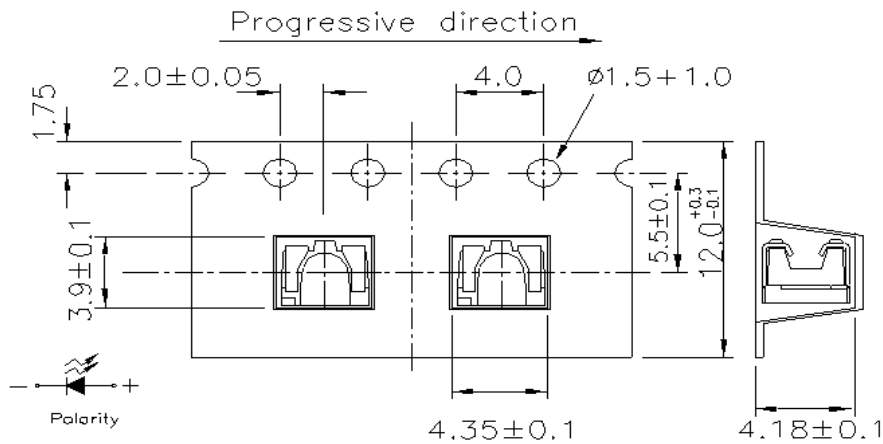

Note: Tolerances unless mentioned ±0.1mm. Unit = mm

**Label Explanation**

- CPN: Customer's Product Number
- P/N: Product Number
- QTY: Packing Quantity
- CAT: Luminous Intensity Rank
- HUE: Dom. Wavelength Rank
- REF: Forward Voltage Rank
- LOT No: Lot Number



**Technical Data Sheet**

**Side View LEDs**

**57-21-GPSC-U8M1N2A5E-BT8-AM**

**Reel Dimensions**

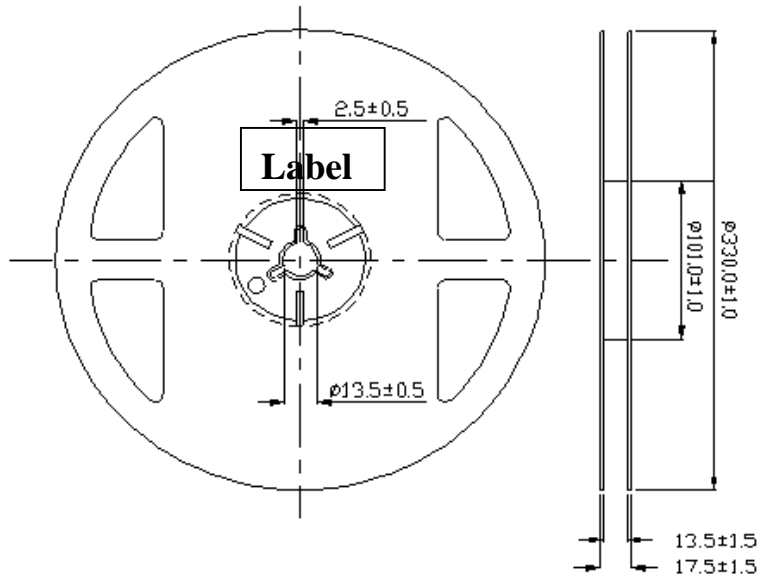

Note: Unit = mm

**Moisture Resistant Packing Process**

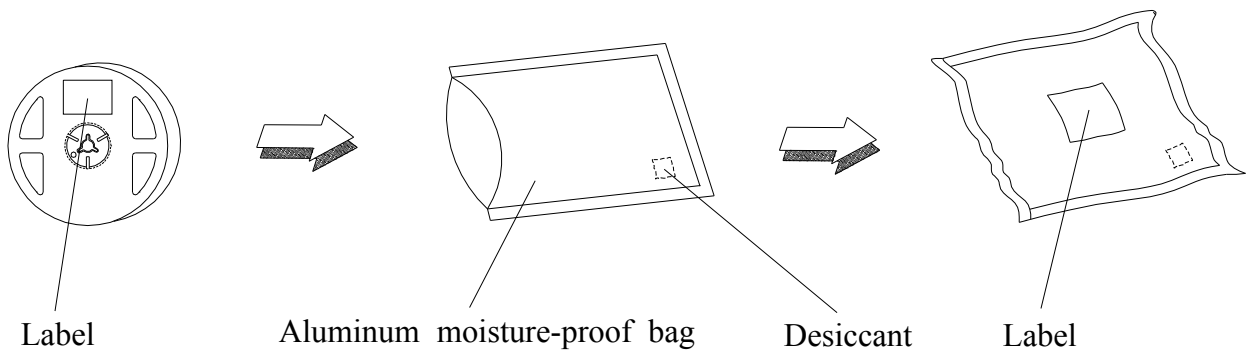

**Technical Data Sheet**

**Side View LEDs**

**57-21-GPSC-U8M1N2A5E-BT8-AM**

**Precautions for Use**

**1. Soldering Condition (Reference: IPC/JEDEC J-STD-020D)**

**a. IR reflow**

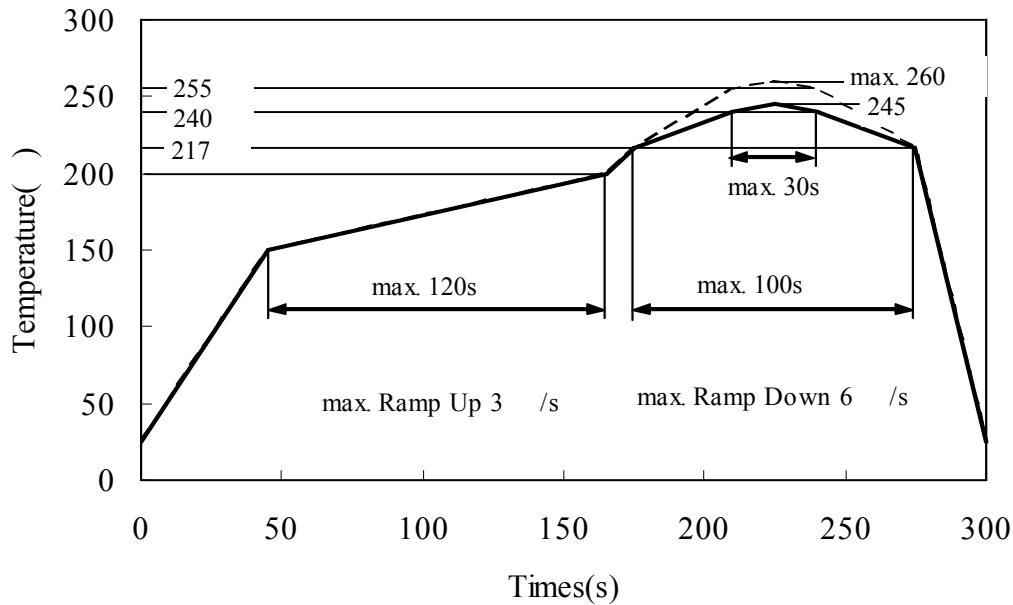

**b. Wave soldering reflow**

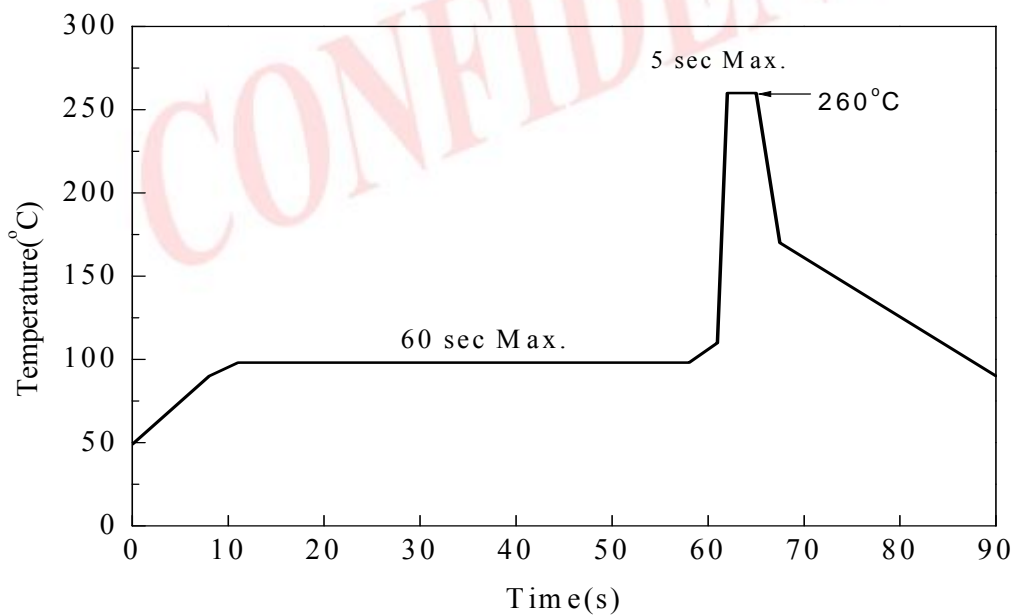

## Technical Data Sheet

### Side View LEDs

#### 57-21-GPSC-U8M1N2A5E-BT8-AM

(B) Recommend soldering pad

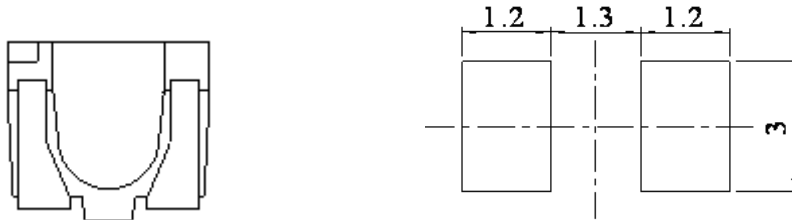

Note: Tolerances unless mentioned  $\pm 0.1$ mm. Unit = mm

#### 2. Current limiting

A resistor should be used to limit current spikes that can be caused by voltage fluctuations. Otherwise damage could occur.

#### 3. Storage

- 3.1 Moisture proof bag should only be opened immediately prior to usage.
- 3.2 Environment should be less than 30 °C and 60% RH when moisture proof bag is opened.
- 3.3 After opening the package MSL Conditions stated on page 1 of this spec should not be exceeded.
- 3.4 If the moisture sensitivity card indicates higher than acceptable moisture, the component should be baked at min. 60deg +/-5deg for 24 hours.

#### 4. Iron Soldering

Hand soldering is not recommended for regular production. These guidelines are for rework only. Soldering iron tip should contact each terminal no more than 3 sec at 350 °C, using soldering iron with nominal power less than 25W. Allow min. 2 sec. between soldering intervals.

#### 5. Usage

Do not exceed the values given in this specification.

### Application Restrictions

High reliability applications such as military/aerospace, automotive safety/security systems, and medical equipment may require different product. If you have any concerns, please contact Everlight before using this product in your application. This specification guarantees the quality and performance of the product as an individual component. Do not use this product beyond the specification described in this document.



**Technical Data Sheet**  
**Side View LEDs**

**57-21-GPSC-U8M1N2A5E-BT8-AM**

**Revision History:**

Rev.	Modified date	File modified contents
1	2009/6/26	New Spec

CONFIDENTIAL