



Technical Data Sheet

Top View LEDs

45-21/RSC-AU1V1B/2T

Features

- P-LCC-2 package.
- Optical indicator.
- Colorless clear window.
- Wide viewing angle.
- Suitable for vapor-phase reflow, Infrared reflow and wave solder processes.
- Computable with automatic placement equipment.
- Available on tape and reel (8mm Tape).
- Pb-free.
- The product itself will remain within RoHS compliant version



Descriptions

- The 45-21 series is available in soft orange, green, blue and yellow. Due to the package design, the LED has wide viewing angle and optimized light coupling by inter reflector. This feature makes the ideal for light pipe application. The low current requirement makes this device ideal for portable equipment or any other application where power is at a premium.

Applications

- Telecommunication: indicator and backlighting in telephone and fax.
- Flat backlight for LCD, switch and symbol.
- Light pipe application.
- General use.

Device Selection Guide

Chip	Emitted Color	Resin Color
Material		
AlGaInP	Brilliant Red	Water Clear

Technical Data Sheet

Top View LEDs

45-21/RSC-AU1V1B/2T

Package Outline Dimensions

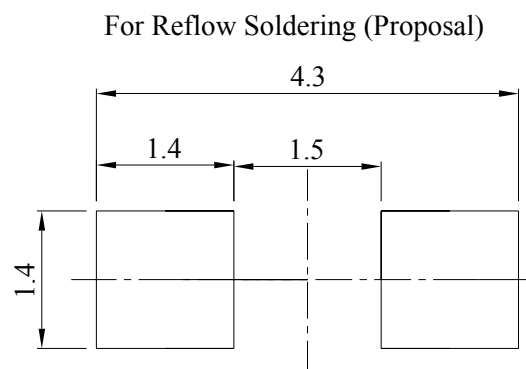
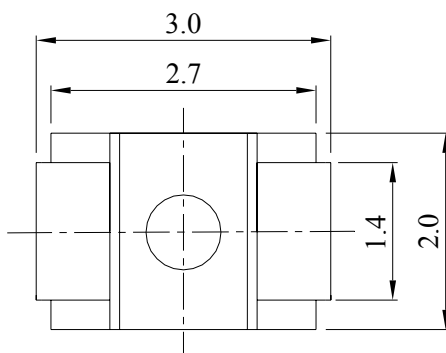
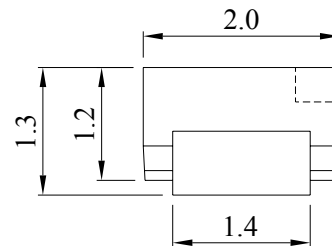
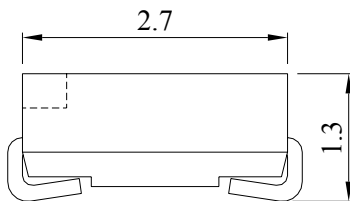
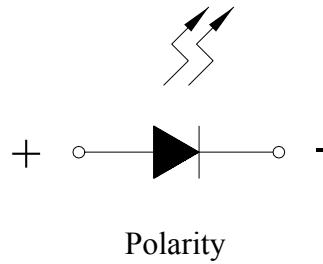
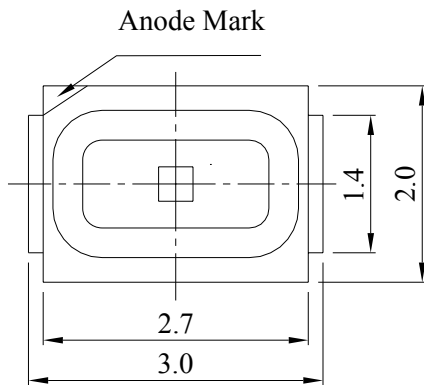

Recommended soldering pad design

Note:

Tolerances unless mentioned is $\pm 0.1\text{mm}$, unit = mm

Technical Data Sheet

Top View LEDs

45-21/RSC-AU1V1B/2T**Absolute Maximum Ratings (Ta=25°C)**

Parameter	Symbol	Rating	Unit
Reverse Voltage	V_R	5	V
Forward Current	I_F	70	mA
Peak Forward Current (Duty 1/10 @1KHz)	I_{FP}	200	mA
Power Dissipation	P_d	180	mW
Electrostatic Discharge(HBM)	ESD	2000	V
Operating Temperature	T_{opr}	-40 ~ +85	°C
Storage Temperature	T_{stg}	-40 ~ +90	°C
Soldering Temperature	T_{sol}	Reflow Soldering : 260 °C for 10 sec. Hand Soldering : 350 °C for 3 sec.	

Electro-Optical Characteristics (Ta=25°C)

Parameter	Symbol	Min.	Typ.	Max.	Unit	Condition
Luminous Intensity	I_V	450	-----	900	mcd	$I_F=20mA$
Viewing Angle	2θ1/2	-----	120	-----	deg	$I_F=20mA$
Peak Wavelength	λ_p	-----	632	-----	nm	$I_F=20mA$
Dominant Wavelength	λ_d	617.5	-----	633.5	nm	$I_F=20mA$
Spectrum Radiation Bandwidth	$\Delta\lambda$	-----	20	-----	nm	$I_F=20mA$
Forward Voltage	V_F	1.75	-----	2.35	V	$I_F=20mA$
Reverse Current	I_R	-----	-----	10	μA	$V_R=5V$

Notes:

- 1.Tolerance of Luminous Intensity: ±11%
- 2.Tolerance of Dominant Wavelength: ±1nm
- 3.Tolerance of Forward Voltage: ±0.05V

Technical Data Sheet**Top View LEDs****45-21/RSC-AU1V1B/2T****Bin Range of Luminous Intensity**

Bin Code	Min.	Max.	Unit	Condition
U1	450	565	mcd	I _F =20mA
U2	565	715		
V1	715	900		

Bin Range of Dominant Wavelength

Groups	Bin	Min	Max	Unit	Condition
A	E4	617.5	621.5	nm	I _F =20mA
	E5	621.5	625.5		
	E6	625.5	629.5		
	E7	629.5	633.5		

Bin Range of Forward Voltage

Groups	Bin	Min	Max	Unit	Condition
B	0	1.75	1.95	V	I _F =20mA
	1	1.95	2.15		
	2	2.15	2.35		

Notes:

- 1.Tolerance of Luminous Intensity: $\pm 11\%$
- 2.Tolerance of Dominant Wavelength: $\pm 1\text{nm}$
- 3.Tolerance of Forward Voltage: $\pm 0.05\text{V}$

Technical Data Sheet
Top View LEDs

45-21/RSC-AU1V1B/2T

Typical Electro-Optical Characteristics Curves

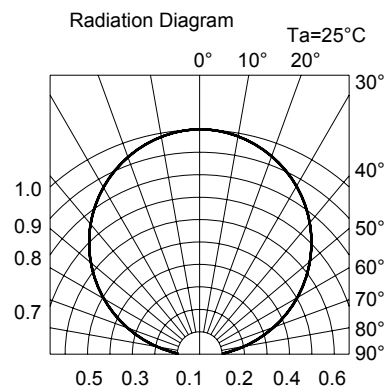
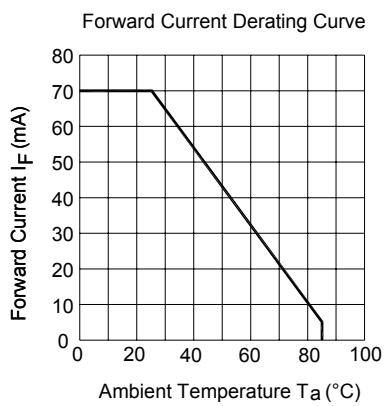
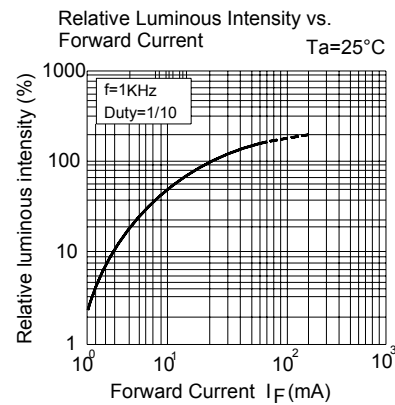
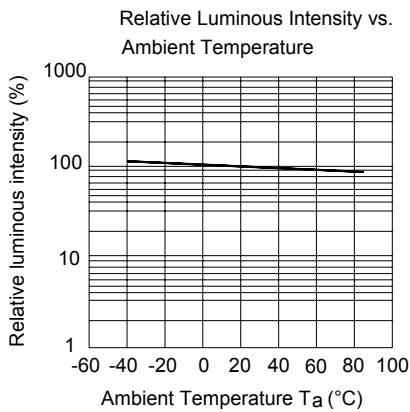
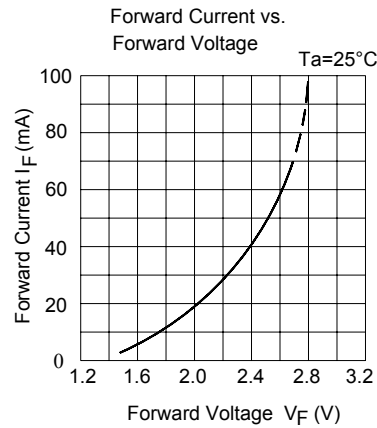
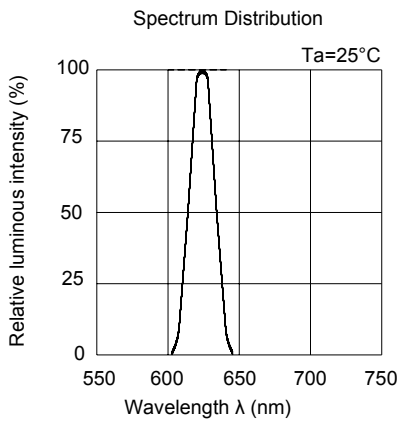



Technical Data Sheet

Top View LEDs

45-21/RSC-AU1V1B/2T

Label explanation

CAT: Luminous Intensity Rank

HUE: Dom. Wavelength Rank

REF: Forward Voltage Rank

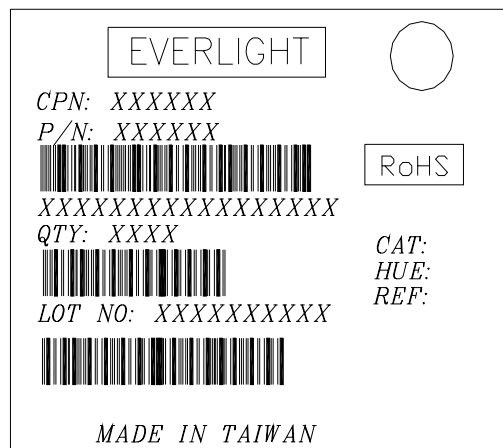

Reel Dimensions

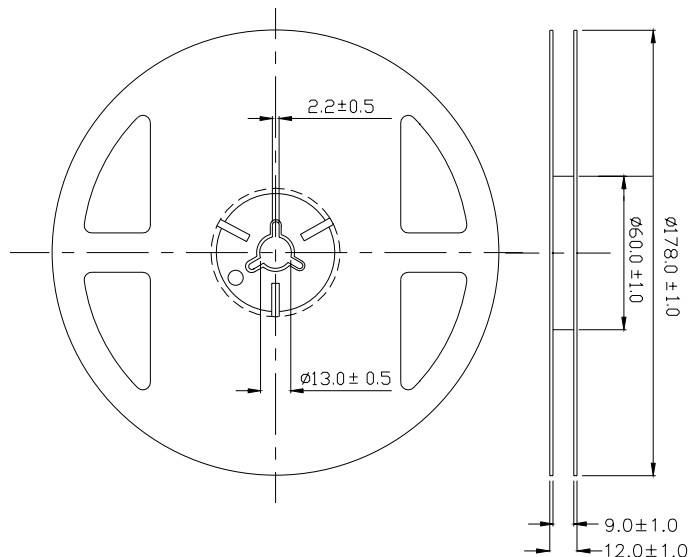

Note:

Tolerances unless mentioned is ±0.1mm,unit = mm

Technical Data Sheet
Top View LEDs

45-21/RSC-AU1V1B/2T

Carrier Tape Dimensions: Loaded Quantity 2000 pcs Per Reel.

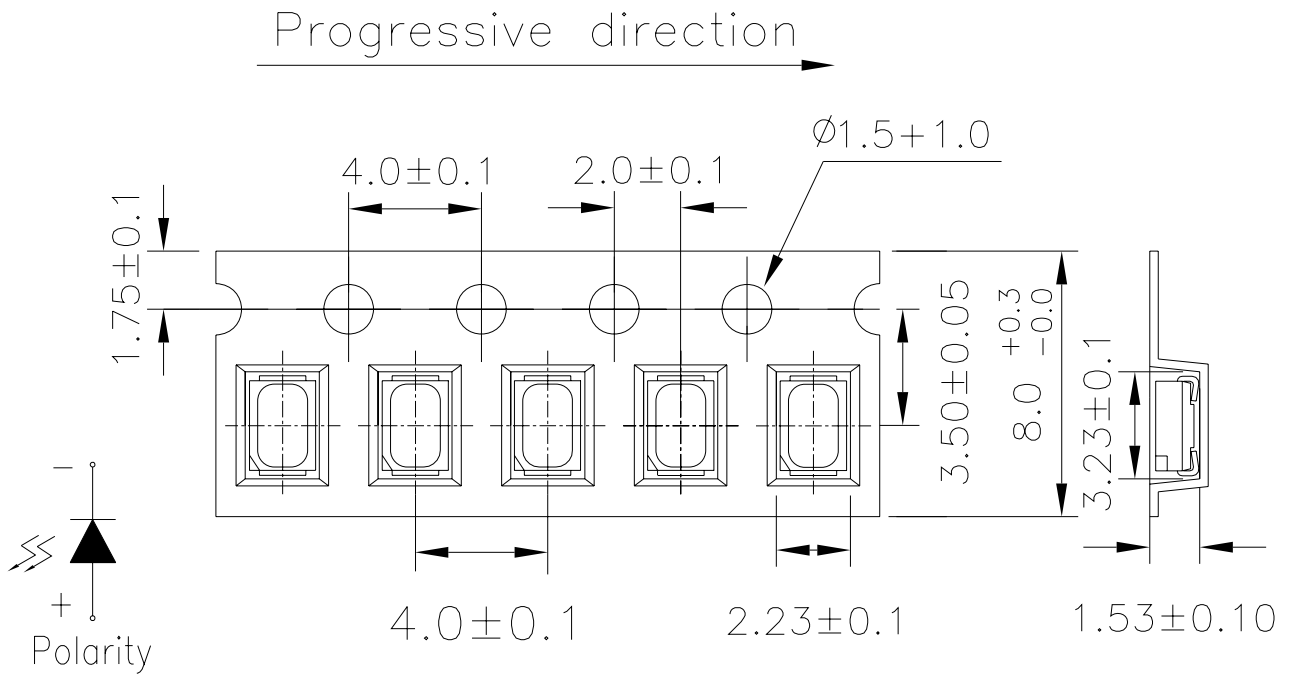

Note:

Tolerances unless mentioned is ±0.1mm, unit = mm

Moisture Resistant Packaging

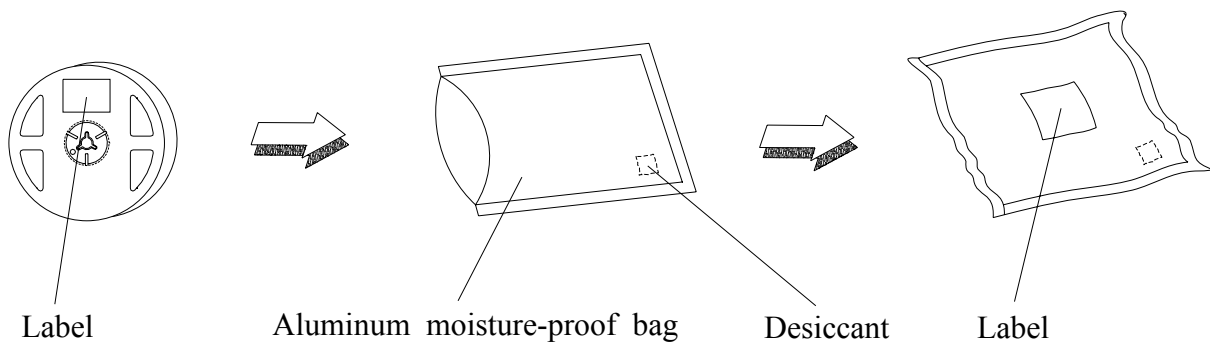



Technical Data Sheet

Top View LEDs

45-21/RSC-AU1V1B/2T

Reliability Test Items And Conditions

The reliability of products shall be satisfied with items listed below.

Confidence level : 90%

LTPD : 10%

No.	Items	Test Condition	Test Hours/Cycles	Sample Size	Ac/Re
1	Reflow Soldering	Temp. : 260°C±5°C Min. 5sec.	6 Min.	22 PCS.	0/1
2	Temperature Cycle	H : +100°C 15min ∫ 5 min L : -40°C 15min	300 Cycles	22 PCS.	0/1
3	Thermal Shock	H : +100°C 5min ∫ 10 sec L : -10°C 5min	300 Cycles	22 PCS.	0/1
4	High Temperature Storage	Temp. : 100°C	1000 Hrs.	22 PCS.	0/1
5	Low Temperature Storage	Temp. : -40°C	1000 Hrs.	22 PCS.	0/1
6	DC Operating Life	I _F = 20 mA	1000 Hrs.	22 PCS.	0/1
7	High Temperature / High Humidity	85°C / 85%RH	1000 Hrs.	22 PCS.	0/1

Technical Data Sheet**Top View LEDs****45-21/RSC-AU1V1B/2T****Precautions For Use**

1. Over-current-proof

Customer must apply resistors for protection, otherwise slight voltage shift will cause big current change (Burn out will happen).

2. Storage

2.1 Do not open moisture proof bag before the products are ready to use.

2.2 Before opening the package: The LEDs should be kept at 30°C or less and 90%RH or less.

2.3 After opening the package: The LED's floor life is 1 year under 30°C or less and 60% RH or less.

If unused LEDs remain, it should be stored in moisture proof packages.

2.4 If the moisture absorbent material (silica gel) has faded away or the LEDs have exceeded the storage time, baking treatment should be performed using the following conditions.

Baking treatment : 60±5°C for 24 hours.

3. Soldering Condition

3.1 Pb-free solder temperature profile

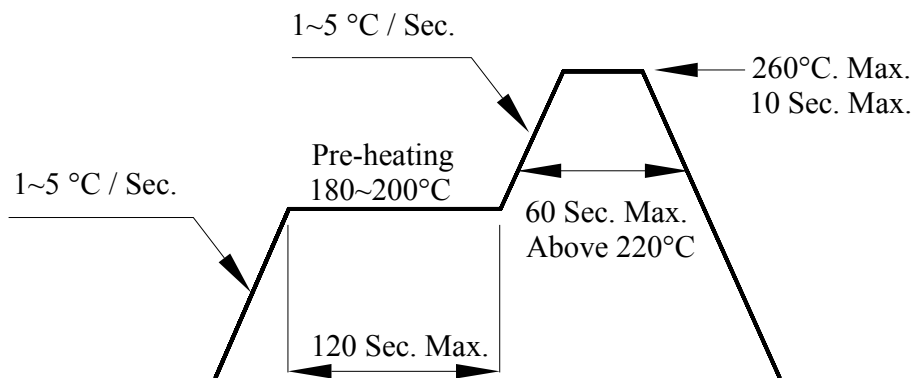

3.2 Reflow soldering should not be done more than two times.

3.3 When soldering, do not put stress on the LEDs during heating.

3.4 After soldering, do not warp the circuit board.

4. Soldering Iron

Each terminal is to go to the tip of soldering iron temperature less than 350°C for 3 seconds within once in less than the soldering iron capacity 25W. Leave two seconds and more intervals, and do soldering of each terminal. Be careful because the damage of the product is often started at the time of the hand solder.

Technical Data Sheet

Top View LEDs

45-21/RSC-AU1V1B/2T

5. Repairing

Repair should not be done after the LEDs have been soldered. When repairing is unavoidable, a double-head soldering iron should be used (as below figure). It should be confirmed beforehand whether the characteristics of the LEDs will or will not be damaged by repairing.

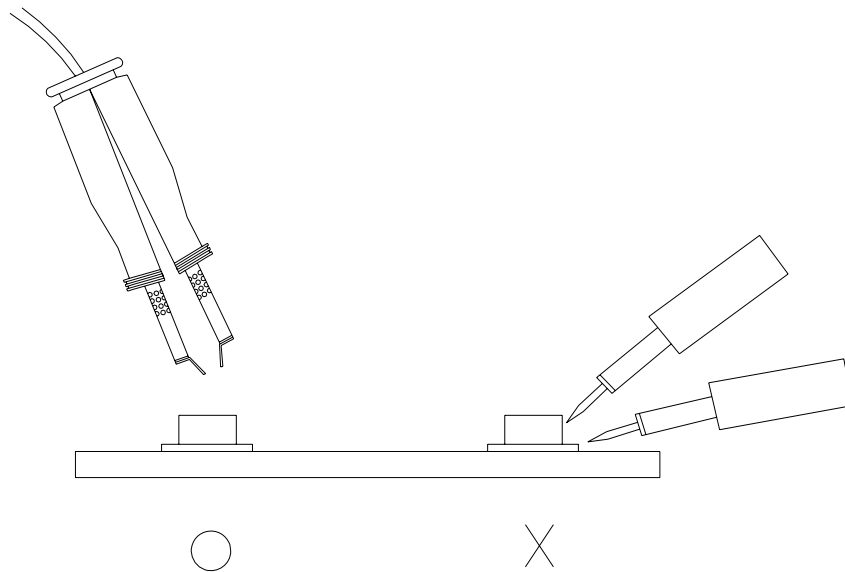

EVERLIGHT ELECTRONICS CO., LTD.
Office: No 25, Lane 76, Sec 3, Chung Yang Rd,
Tucheng, Taipei 236, Taiwan, R.O.C

Tel: 886-2-2267-2000, 2267-9936
Fax: 886-2267-6244, 2267-6189, 2267-6306
<http://www.everlight.com>