

**Technical Data Sheet****Top View LED****45-21/B7C-FS1T2G/2T****Features**

- P-LCC-2 package
- White package
- Optical indicator
- Colorless clear window
- Wide viewing angle
- Suitable for vapor-phase reflow, infrared reflow and wave solder processes
- Computable with automatic placement equipment
- Available on tape and reel (8mm Tape)
- Pb-free
- The product itself will remain within RoHS compliant version.

**Descriptions**

- The 45-21 series is available in soft orange, green, blue and yellow. Due to the package design, the LED has wide viewing angle and optimized light coupling by inter reflector. This feature makes the device ideal for light pipe application. The low current requirement makes this device ideal for portable equipment or any other application where power is at a premium.

**Applications**

- Telecommunication: indicator and backlighting in telephone and fax
- Flat backlight for LCD, switch and symbol
- Light pipe application
- General use

**Device Selection Guide**

Chip	Emitted Color	Resin Color
Material		
InGaN	Blue	Water Clear

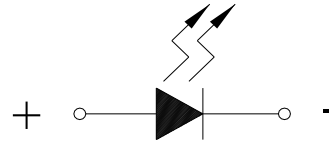
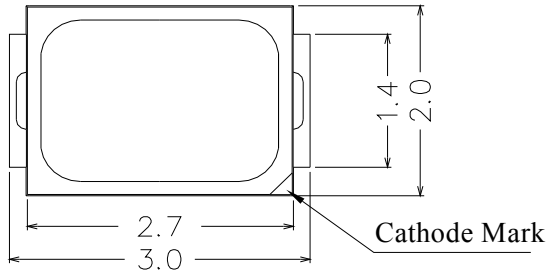
**Technical Data Sheet****Top View LED****45-21/B7C-FS1T2G/2T****Package Outline Dimensions**

Polarity

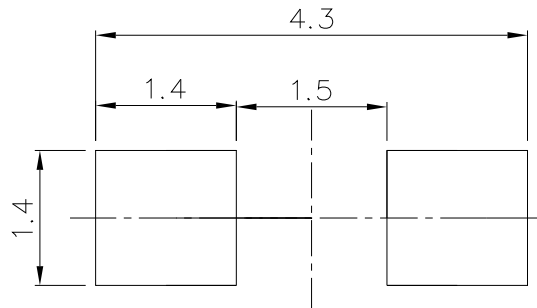
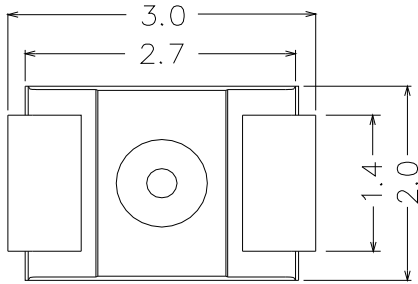
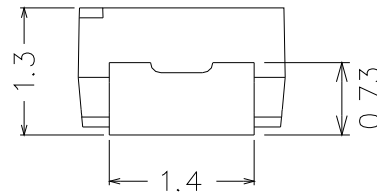
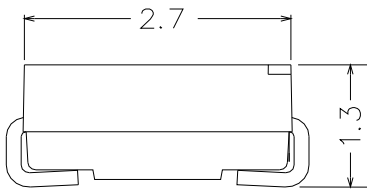

Recommended soldering pad design

**Note:** Tolerances unless mentioned are  $\pm 0.1$ mm, unit = mm.

**Technical Data Sheet****Top View LED****45-21/B7C-FS1T2G/2T****Absolute Maximum Ratings (Ta=25°C)**

Parameter	Symbol	Rating	Unit
Reverse Voltage	V <sub>R</sub>	5	V
Forward Current	I <sub>F</sub>	30	mA
Peak Forward Current (Duty 1/10 @1KHz)	I <sub>FP</sub>	100	mA
Power Dissipation	P <sub>d</sub>	110	mW
Electrostatic Discharge(HBM)	ESD	1000	V
Operating Temperature	T <sub>opr</sub>	-40 ~ +85	°C
Storage Temperature	T <sub>stg</sub>	-40 ~ +90	°C
Soldering Temperature	T <sub>sol</sub>	Reflow Soldering : 260°C for 10 sec. Hand Soldering : 350°C for 3 sec.	

**Electro-Optical Characteristics (Ta=25°C)**

Parameter	Symbol	Min.	Typ.	Max.	Unit	Condition
Luminous Intensity	I <sub>v</sub>	180	----	450	mcd	I <sub>F</sub> =20mA
Viewing Angle	2θ <sub>1/2</sub>	----	120	----	deg	
Peak Wavelength	λ <sub>p</sub>	----	468	----	nm	
Dominant Wavelength	λ <sub>d</sub>	464	----	472	nm	
Spectrum Radiation Bandwidth	Δλ	----	25	----	nm	
Forward Voltage	V <sub>F</sub>	2.7	----	3.7	V	
Reverse Current	I <sub>R</sub>	----	----	50	μA	V <sub>R</sub> =5V

**Notes:**

1. Tolerance of Luminous Intensity: ±11%
2. Tolerance of Dominant Wavelength: ±1nm
3. Tolerance of Forward Voltage: ±0.05V



Technical Data Sheet

Top View LED

45-21/B7C-FS1T2G/2T

**Bin Range of Luminous Intensity**

Bin Code	Min.	Max.	Unit	Conduction
S1	180	225	mcd	I <sub>F</sub> =20mA
S2	225	285		
T1	285	360		
T2	360	450		

**Bin Range of Dominant Wavelength**

Groups	Bin	Min	Max	Unit	Condition
B	AA1	464.0	466.0	nm	I <sub>F</sub> =20mA
	AA2	466.0	468.0		
	AA3	468.0	470.0		
	AA4	470.0	472.0		



LIGHTING FOREVER

Technical Data Sheet

Top View LED

45-21/B7C-FS1T2G/2T

Bin Range of Forward Voltage

Groups	Bin Code	Min.	Max.	Unit	Condition
G	34	2.7	2.8	V	IF=20mA
	35	2.8	2.9		
	36	2.9	3.0		
	37	3.0	3.1		
	38	3.1	3.2		
	39	3.2	3.3		
	40	3.3	3.4		
	41	3.4	3.5		
	42	3.5	3.6		
	43	3.6	3.7		

Notes:

1. Tolerance of Luminous Intensity:  $\pm 11\%$
2. Tolerance of Dominant Wavelength:  $\pm 1\text{nm}$
3. Tolerance of Forward Voltage:  $\pm 0.1\text{V}$

**Technical Data Sheet**

**Top View LED**

**45-21/B7C-FS1T2G/2T**

**Typical Electro-Optical Characteristics Curves**

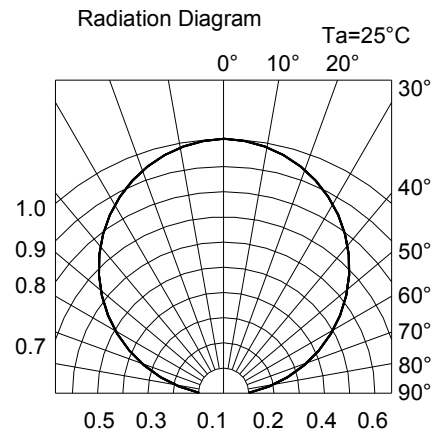
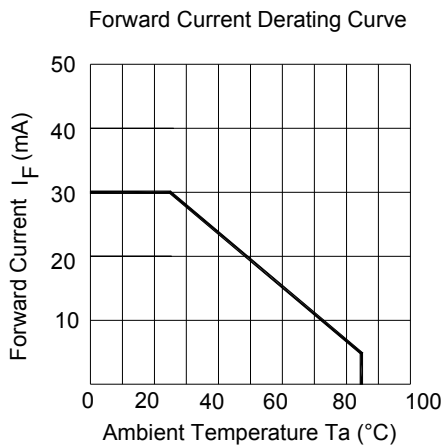
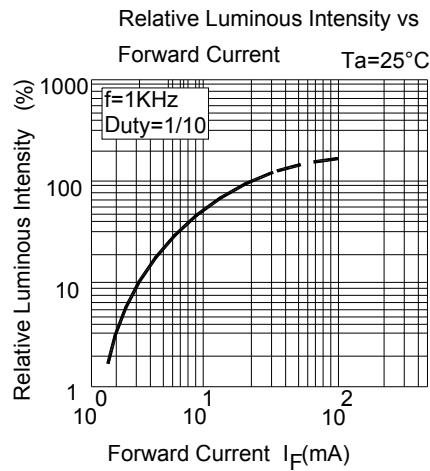
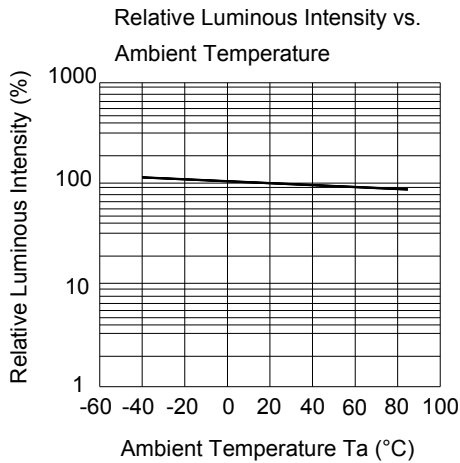
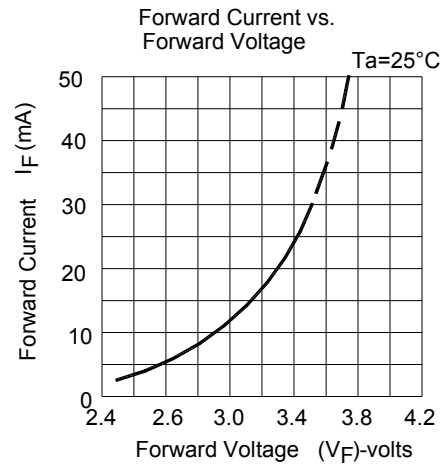
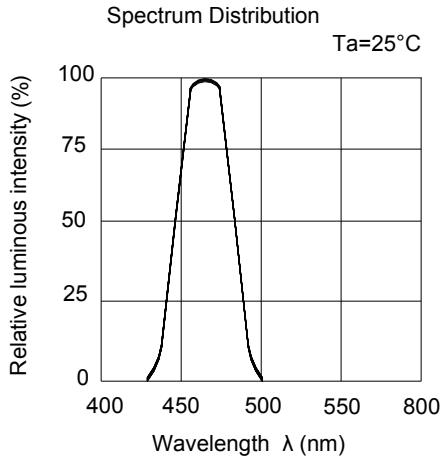



LIGHTING FOREVER

Technical Data Sheet

Top View LED

**45-21/B7C-FS1T2G/2T**

Label Explanation

CAT: Luminous Intensity Rank

HUE: Dom. Wavelength Rank

REF: Forward Voltage Rank



Reel Dimensions

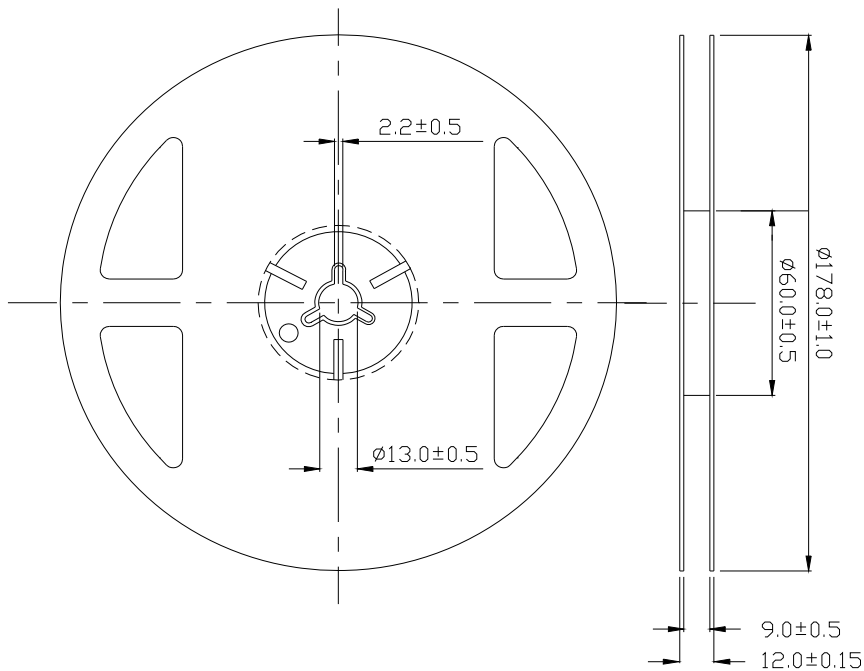

Note: Tolerance unless mentioned is ±0.1mm, unit = mm.

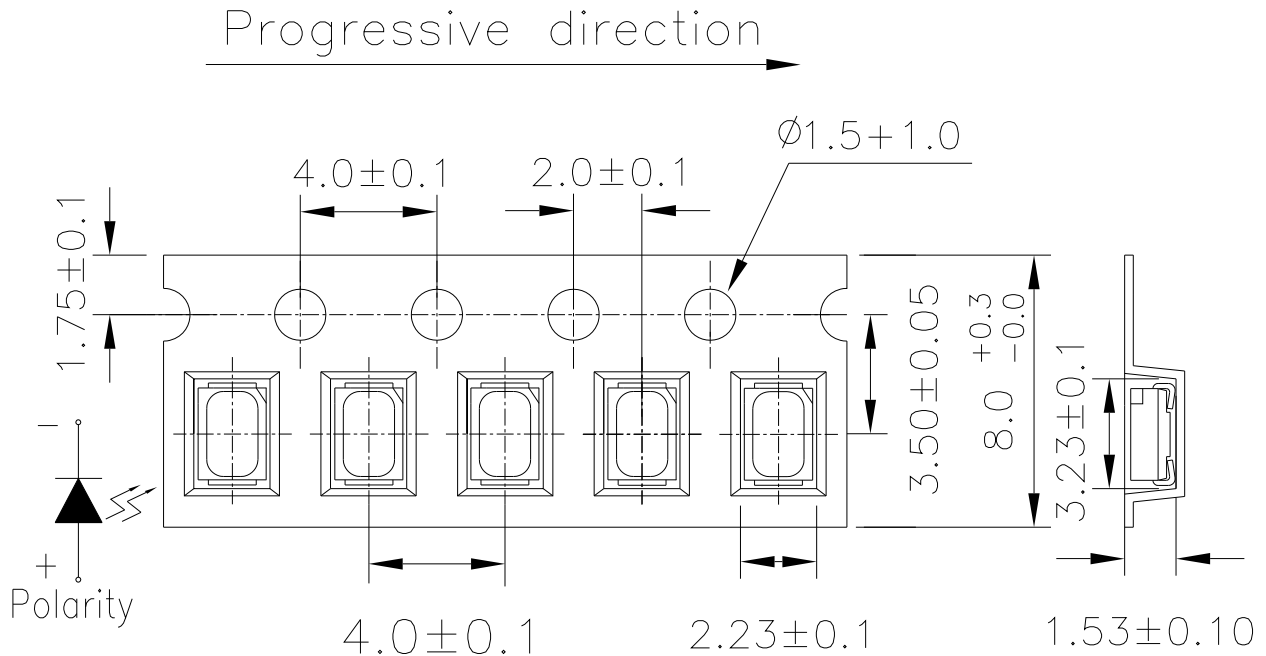
**Technical Data Sheet**
**Top View LED**
**45-21/B7C-FS1T2G/2T**
**Carrier Tape Dimensions: Loaded Quantity 2000 pcs. Per Reel**

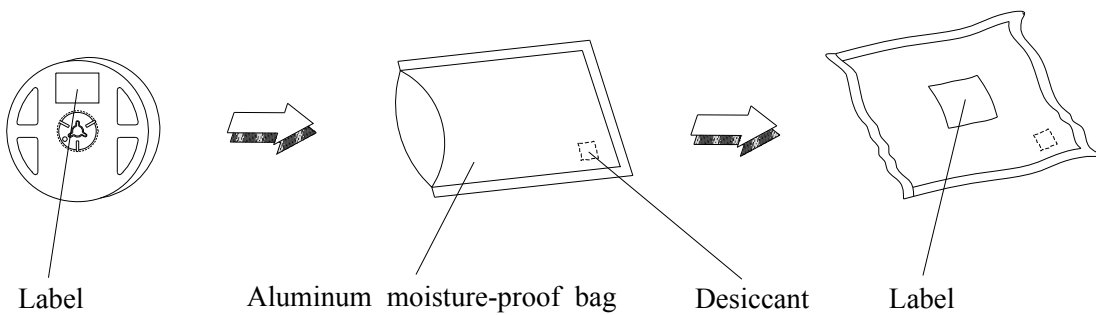
**Note:** Tolerance unless mentioned is  $\pm 0.1$ mm, unit = mm.

**Moisture Resistant Packaging**





LIGHTING FOREVER

**Technical Data Sheet**

**Top View LED**

**45-21/B7C-FS1T2G/2T**

**Reliability Test Items and Conditions**

The reliability of products shall be satisfied with items listed below.

Confidence level : 90%

LTPD : 10%

No.	Items	Test Condition	Test Hours/Cycles	Sample Size	Ac/Re
1	Reflow Soldering	Temp. : 260°C±5°C Min. 5sec.	6 Min.	22 pcs.	0/1
2	Temperature Cycle	H : +100°C 15min ∫ 5 min L : -40°C 15min	300 Cycles	22 pcs.	0/1
3	Thermal Shock	H : +100°C 5min ∫ 10 sec L : -10°C 5min	300 Cycles	22 pcs.	0/1
4	High Temperature Storage	Temp. : 100°C	1000 Hrs.	22 pcs.	0/1
5	Low Temperature Storage	Temp. : -40°C	1000 Hrs.	22 pcs.	0/1
6	DC Operating Life	I <sub>F</sub> = 20 mA	1000 Hrs.	22 pcs.	0/1
7	High Temperature / High Humidity	85°C / 85%RH	1000 Hrs.	22 pcs.	0/1

**Technical Data Sheet****Top View LED****45-21/B7C-FS1T2G/2T****Precautions for Use**

## 1. Over-current-proof

Customer must apply resistors for protection; otherwise slight voltage shift will cause big current change (Burn out will happen).

## 2. Storage

2.1 Do not open moisture proof bag before the products are ready to use.

2.2 Before opening the package: The LEDs should be kept at 30°C or less and 90%RH or less.

2.3 After opening the package: The LED's floor life is 1 year under 30°C or less and 60% RH or less.

If unused LEDs remain, it should be stored in moisture proof packages.

2.4 If the moisture absorbent material (silica gel) has faded away or the LEDs have exceeded the storage time, baking treatment should be performed using the following conditions.

Baking treatment : 60±5°C for 24 hours.

## 3. Soldering Condition

## 3.1 Pb-free solder temperature profile

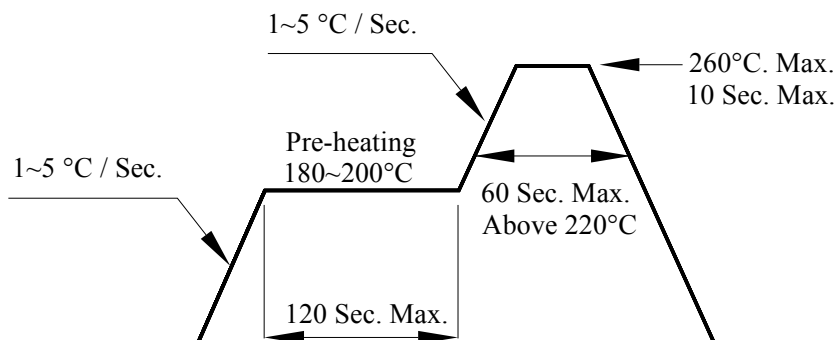

3.2 Reflow soldering should not be done more than two times.

3.3 When soldering, do not put stress on the LEDs during heating.

3.4 After soldering, do not warp the circuit board.

**Technical Data Sheet****Top View LED****45-21/B7C-FS1T2G/2T****4. Soldering Iron**

Each terminal is to go to the tip of soldering iron temperature less than 350°C for 3 seconds within once in less than the soldering iron capacity 25W. Leave two seconds and more intervals, and do soldering of each terminal. Be careful because the damage of the product is often started at the time of the hand solder.

**5. Repairing**

Repair should not be done after the LEDs have been soldered. When repairing is unavoidable, a double-head soldering iron should be used (as below figure). It should be confirmed beforehand whether the characteristics of the LEDs will or will not be damaged by repairing.

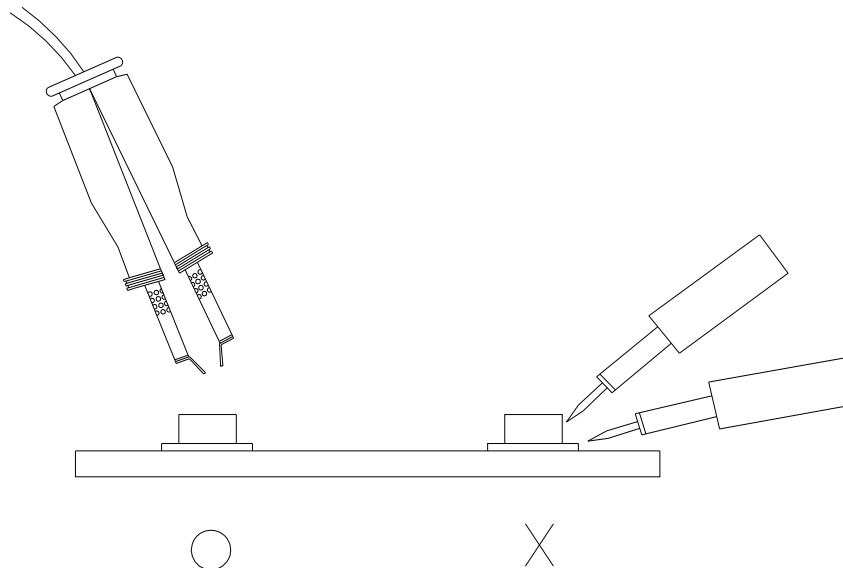
**EVERLIGHT ELECTRONICS CO., LTD.**

Office: No 25, Lane 76, Sec 3, Chung Yang Rd,  
Tucheng, Taipei 236, Taiwan, R.O.C

Tel: 886-2-2267-2000, 2267-9936

Fax: 886-2267-6244, 2267-6189, 2267-6306

<http://www.everlight.com>