

# HSMx-C120/C177/C197/C265

## High Performance Chip LEDs



## Data Sheet



### Description

These chip type LEDs utilize Aluminium Indium Gallium Phosphide (AlInGaP) material technology. The AlInGaP material has a very high luminous efficiency, capable of producing high light output over a wide range of drive currents. The available colors in this surface mount series are 592 nm Amber, 605 nm Orange, 626 nm Red and 639 nm Deep Red.

All packages are binned by both color and intensity, except for red and deep red color.

These ChipLEDs come either in low profile top emitting packages (HSMx-C177/C197), in a side emitting package (HSMx-C120) or in a reverse mount package (HSMx-C265). The right angle ChipLED is suitable for applications such as LCD back lighting. The top emitting ChipLEDs with wide viewing angle are suitable for light piping and direct backlighting of keypads and panels. The reverse mount ChipLED is suitable for space saving.

In order to facilitate pick and place operation, these ChipLEDs are shipped in tape and reel, with 4000 units per reel for HSMx-C120/C177/C197 and 3000 units per reel for HSMx-C265.

These packages are compatible with IR soldering process.

### Features

- High brightness AlInGaP material
- 0805 or 0603 industry standard footprint with 0.4 mm height for top emitting packages
- Also available in right angle emitting and reverse mounting packages
- Diffused optics
- Operating temperature range of  $-30^{\circ}\text{C}$  to  $+85^{\circ}\text{C}$
- Compatible with IR soldering
- Available in 4 colors
- Available in 8 mm tape on 7" diameter reel
- Reel sealed in zip locked moisture barrier bags

### Applications

- Membrane switch indicator
- LCD backlighting
- Push button backlighting
- Front panel indicator
- Symbol backlighting
- Keypad backlighting
- Microdisplays
- Small message panel signage

### Device Selection Guide

| Dimensions (mm) <sup>[1,2]</sup> | Amber     | Red       | Orange    | Deep Red  | Package Description    |
|----------------------------------|-----------|-----------|-----------|-----------|------------------------|
| 1.6 x 1.0 x 0.6                  | HSMA-C120 | HSMC-C120 | HSML-C120 | -         | Untinted, Non-diffused |
| 2.0 x 1.25 x 0.4                 | HSMA-C177 | HSMC-C177 | HSML-C177 | HSMT-C177 | Untinted, Diffused     |
| 1.6 x 0.8 x 0.4                  | HSMA-C197 | HSMC-C197 | HSML-C197 | HSMT-C197 | Untinted, Diffused     |
| 3.4 x 1.25 x 1.1                 | HSMA-C265 | HSMC-C265 | HSML-C265 | HSMT-C265 | Untinted, Non-diffused |

**CAUTION:** HSMA-Cxxx, HSMC-Cxxx, HSML-Cxxx and HSMT-Cxxx LEDs are Class 1A ESD sensitive per JESD22-A114C.01. Please observe appropriate precautions during handling and processing. Refer to Application Note AN-1142 for additional details.

## Package Dimensions

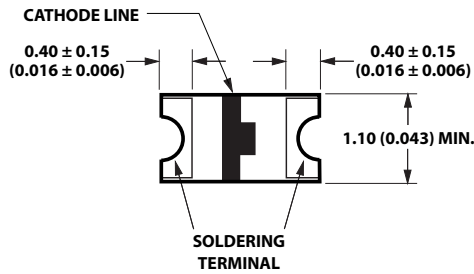
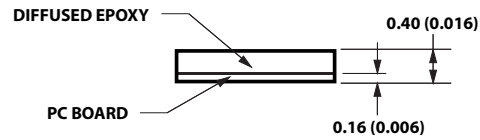
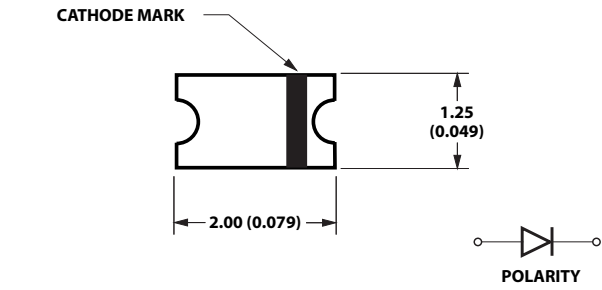

HSMx-C177

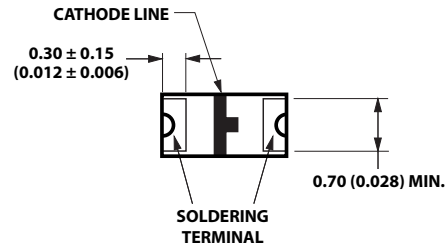
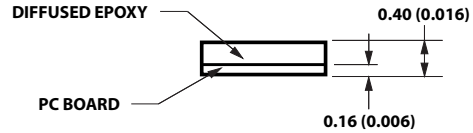
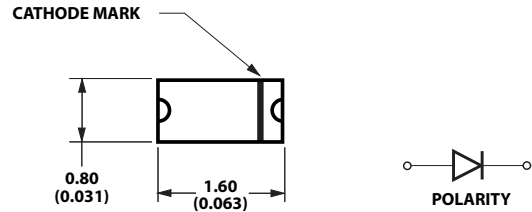

HSMx-C197

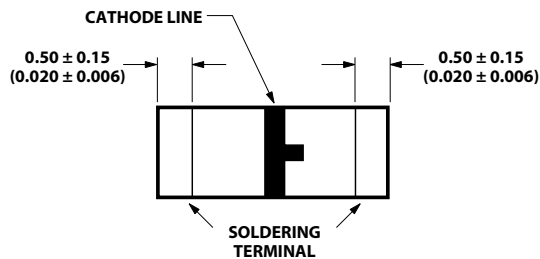
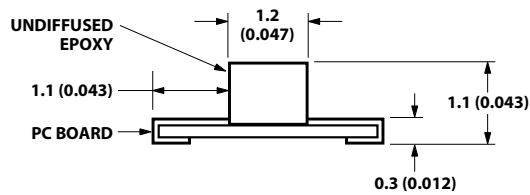
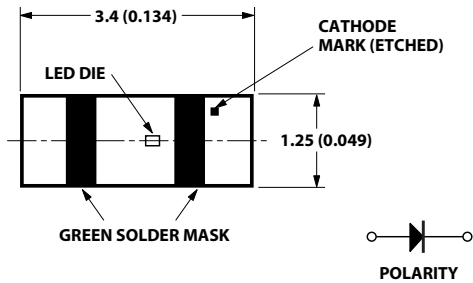

HSMx-C265

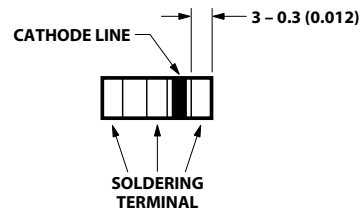
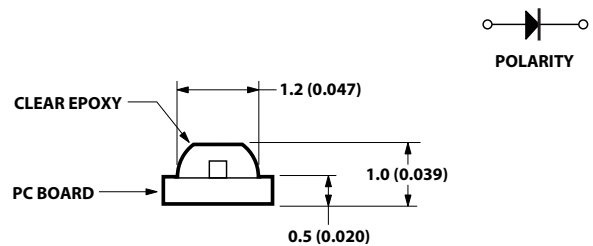
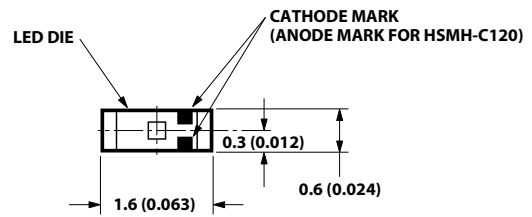

HSMx-C120

### NOTES:

1. ALL DIMENSIONS IN MILLIMETERS (INCHES).
2. TOLERANCE IS ± 0.1 mm (± 0.004 IN.) UNLESS OTHERWISE SPECIFIED.

### Absolute Maximum Ratings at $T_A = 25^\circ\text{C}$

| Parameter                                    | HSMx-Cxxx                                    | Units            |
|--|--|------------------|
| DC Forward Current <sup>[1]</sup>            | 25   | mA               |
| Peak Pulsing Current <sup>[2]</sup>          | 100  | mA               |
| Power Dissipation                            | 60   | mW               |
| Reverse Voltage ( $I_R = 100\ \mu\text{A}$ ) | 5  | V                |
| LED Junction Temperature                     | 95   | $^\circ\text{C}$ |
| Operating Temperature Range                  | -30 to +85                                   | $^\circ\text{C}$ |
| Storage Temperature Range                    | -40 to +85                                   | $^\circ\text{C}$ |
| Soldering Temperature                        | See reflow soldering profile (Figures 8 & 9) |                  |

Notes:

1. Derate linearly as shown in Figure 4.
2. Pulse condition of 1/10 duty and 0.1 ms width.

### Electrical Characteristics at $T_A = 25^\circ\text{C}$

| Part Number   | Forward Voltage<br>$V_F$ (Volts)<br>@ $I_F = 20\ \text{mA}$ |      | Reverse Breakdown<br>$V_R$ (Volts)<br>@ $I_R = 100\ \mu\text{A}$ | Capacitance C<br>(pF), $V_F = 0$ ,<br>$f = 1\ \text{MHz}$ | Thermal<br>Resistance<br>$R_{\theta J-PIN}$ ( $^\circ\text{C/W}$ ) |
|---------------|---|------|--|---|--|
|               | Typ.  | Max. | Min.   | Typ.  | Typ.   |
| HSMA-C120     | 1.9   | 2.4  | 5  | 11  | 400  |
| HSMA-C177/197 | 1.9   | 2.4  | 5  | 11  | 300  |
| HSMA-C265     | 1.9   | 2.4  | 5  | 11  | 550  |
| HSMC-C120     | 1.9   | 2.4  | 5  | 15  | 400  |
| HSMC-C177/197 | 1.9   | 2.4  | 5  | 15  | 300  |
| HSMC-C265     | 1.9   | 2.4  | 5  | 15  | 550  |
| HSML-C120     | 1.9   | 2.4  | 5  | 20  | 400  |
| HSML-C177/197 | 1.9   | 2.4  | 5  | 20  | 300  |
| HSML-C265     | 1.9   | 2.4  | 5  | 20  | 550  |
| HSMT-C177/197 | 1.9   | 2.4  | 5  | 15  | 300  |
| HSMT-C265     | 1.9   | 2.4  | 5  | 15  | 550  |

$V_F$  Tolerance:  $\pm 0.1\ \text{V}$

### Optical Characteristics at $T_A = 25^\circ\text{C}$

| Part Number   | Color    | Luminous Intensity $I_V$ (mcd) @ 20 mA <sup>[1]</sup> |      | Color, Peak Wavelength $\lambda_{\text{peak}}$ (nm) | Dominant Wavelength $\lambda_d$ <sup>[2]</sup> (nm) | Viewing Angle $2 \theta_{1/2}$ Degrees <sup>[3]</sup> | Luminous Efficacy $\eta_V$ (lm/w) |
|---------------|----------|---|------|---|---|---|-----------------------------------|
|               |          | Min.  | Typ. | Typ.  | Typ.  | Typ.  | Typ.                              |
| HSMA-C120     | Amber    | 28.5  | 90   | 595   | 592   | 155   | 480                               |
| HSMA-C177/197 | Amber    | 28.5  | 90   | 595   | 592   | 130   | 480                               |
| HSMA-C265     | Amber    | 28.5  | 75   | 595   | 592   | 150   | 480                               |
| HSMC-C120     | Red      | 28.5  | 90   | 637   | 626   | 155   | 155                               |
| HSMC-C177/197 | Red      | 28.5  | 90   | 637   | 626   | 130   | 155                               |
| HSMC-C265     | Red      | 28.5  | 75   | 637   | 626   | 150   | 155                               |
| HSML-C120     | Orange   | 28.5  | 90   | 609   | 605   | 155   | 370                               |
| HSML-C177/197 | Orange   | 28.5  | 90   | 609   | 605   | 130   | 370                               |
| HSML-C265     | Orange   | 28.5  | 75   | 609   | 605   | 150   | 370                               |
| HSMT-C177/197 | Deep Red | 11.2  | 30   | 660   | 639   | 130   | 70                                |
| HSMT-C265     | Deep Red | 11.2  | 25   | 660   | 639   | 150   | 70                                |

Notes:

1. The luminous intensity,  $I_V$ , is measured at the peak of the spatial radiation pattern which may not be aligned with the mechanical axis of the lamp package.
2. The dominant wavelength,  $\lambda_d$ , is derived from the CIE Chromaticity Diagram and represents the perceived color of the device.
3.  $\theta_{1/2}$  is the off-axis angle where the luminous intensity is 1/2 the peak intensity.

**Color Bin Limits**

| <b>Orange Color Bins<sup>[1]</sup></b> |             |             |
|--|-------------|-------------|
| <b>Dom. Wavelength (nm)</b>            |             |             |
| <b>Bin ID</b>                          | <b>Min.</b> | <b>Max.</b> |
| A                                      | 597.0       | 600.0       |
| B                                      | 600.0       | 603.0       |
| C                                      | 603.0       | 606.0       |
| D                                      | 606.0       | 609.0       |
| E                                      | 609.0       | 612.0       |
| F                                      | 612.0       | 615.0       |

Tolerance: ± 1 nm

| <b>Amber Color Bins<sup>[1]</sup></b> |             |             |
|---------------------------------------|-------------|-------------|
| <b>Dom. Wavelength (nm)</b>           |             |             |
| <b>Bin ID</b>                         | <b>Min.</b> | <b>Max.</b> |
| A                                     | 582.0       | 584.5       |
| B                                     | 584.5       | 587.0       |
| C                                     | 587.0       | 589.5       |
| D                                     | 589.5       | 592.0       |
| E                                     | 592.0       | 594.5       |
| F                                     | 594.5       | 597.0       |

Tolerance: ± 1 nm

| <b>Red Color Bins<sup>[1]</sup></b> |             |             |
|-------------------------------------|-------------|-------------|
| <b>Dom. Wavelength (nm)</b>         |             |             |
| <b>Bin ID</b>                       | <b>Min.</b> | <b>Max.</b> |
| -                                   | 620.0       | 635.0       |

Tolerance: ±1 nm

Note:

1. Bin categories are established for classification of products. Products may not be available in all categories. Please contact your Avago representative for information on currently available bins.

**Light Intensity (Iv) Bin Limits<sup>[1]</sup>**

| <b>Intensity (mcd)</b> |             |             |
|------------------------|-------------|-------------|
| <b>Bin ID</b>          | <b>Min.</b> | <b>Max.</b> |
| A                      | 0.11        | 0.18        |
| B                      | 0.18        | 0.29        |
| C                      | 0.29        | 0.45        |
| D                      | 0.45        | 0.72        |
| E                      | 0.72        | 1.10        |
| F                      | 1.10        | 1.80        |
| G                      | 1.80        | 2.80        |
| H                      | 2.80        | 4.50        |
| J                      | 4.50        | 7.20        |
| K                      | 7.20        | 11.20       |
| L                      | 11.20       | 18.00       |
| M                      | 18.00       | 28.50       |
| N                      | 28.50       | 45.00       |
| P                      | 45.00       | 71.50       |
| Q                      | 71.50       | 112.50      |
| R                      | 112.50      | 180.00      |
| S                      | 180.00      | 285.00      |
| T                      | 285.00      | 450.00      |
| U                      | 450.00      | 715.00      |
| V                      | 715.00      | 1125.00     |
| W                      | 1125.00     | 1800.00     |
| X                      | 1800.00     | 2850.00     |
| Y                      | 2850.00     | 4500.00     |

Tolerance: ± 15%

Notes:

1. Bin categories are established for classification of products. Products may not be available in all categories. Please contact your Avago representative for information on currently available bins.
2. The Iv binning specification set-up is for lowest allowable Iv binning only. There are no upper Iv bin limits.

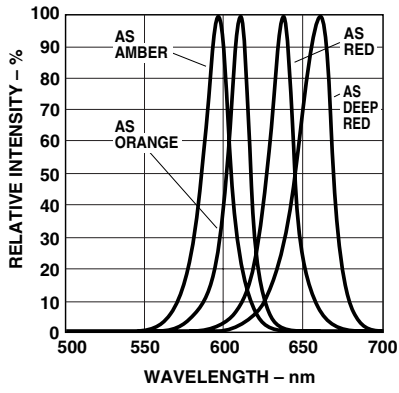

Figure 1. Relative intensity vs. wavelength.

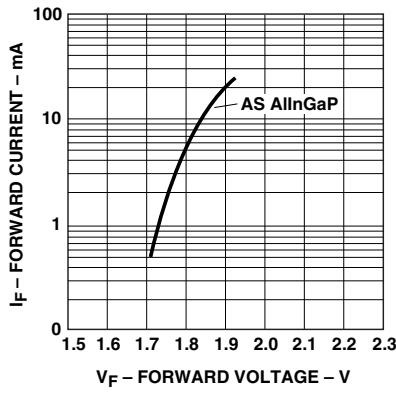

Figure 2. Forward current vs. forward voltage.

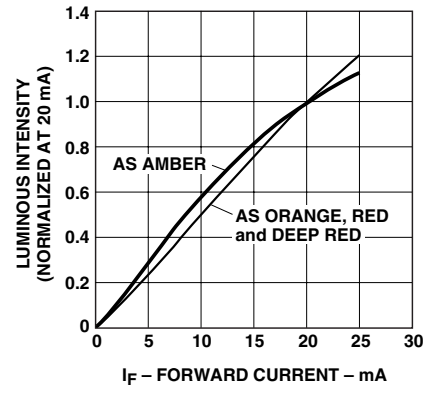

Figure 3. Luminous intensity vs. forward current.

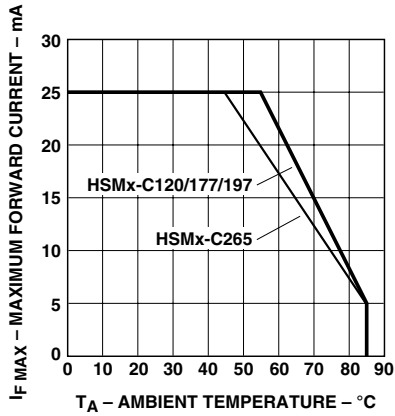

Figure 4. Maximum forward current vs. ambient temperature.

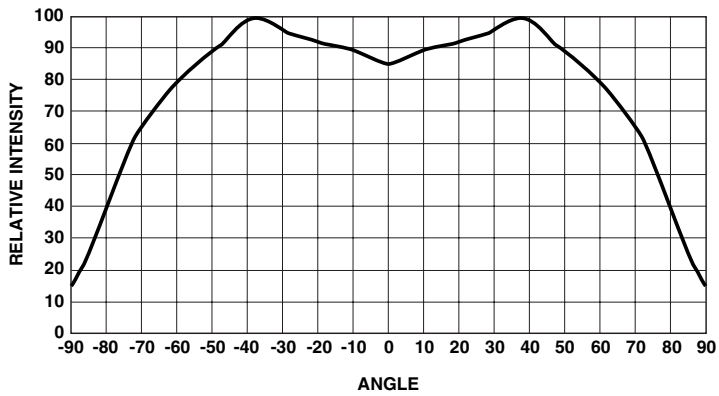
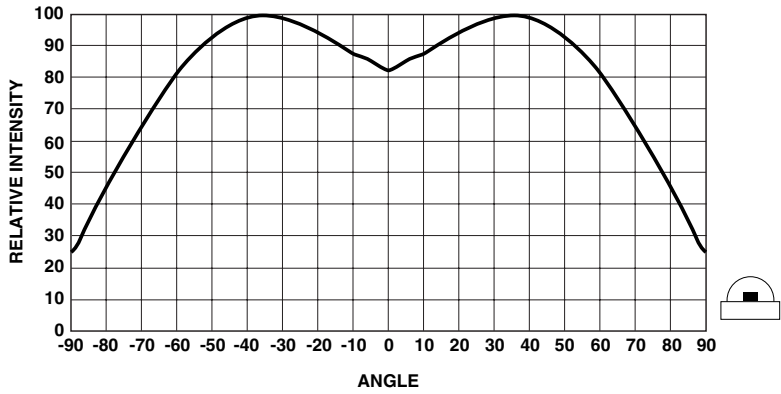

Figure 5. Relative intensity vs. angle for HSMx-C120.

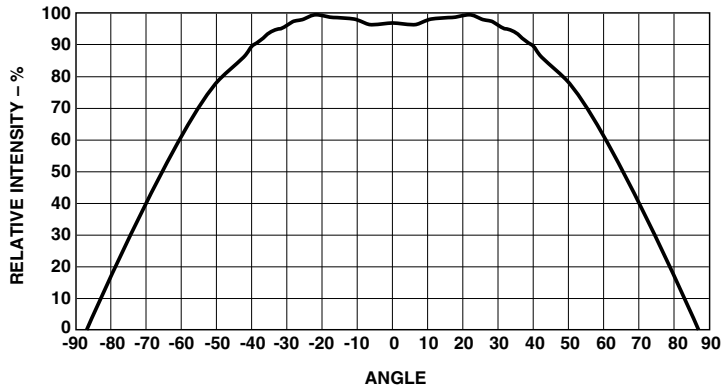

Figure 6. Relative intensity vs. angle for HSMx-C177/197.

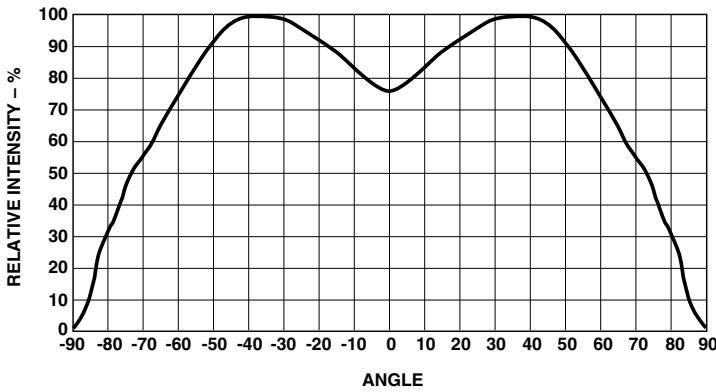

Figure 7. Relative intensity vs. angle for HSMx-C265.

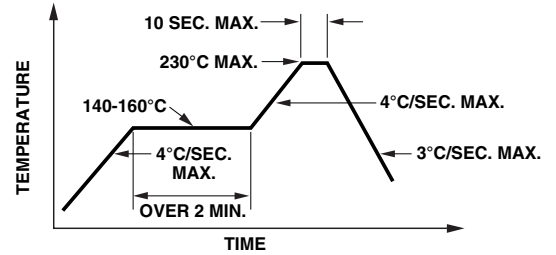

Figure 8. Recommended reflow soldering profile.

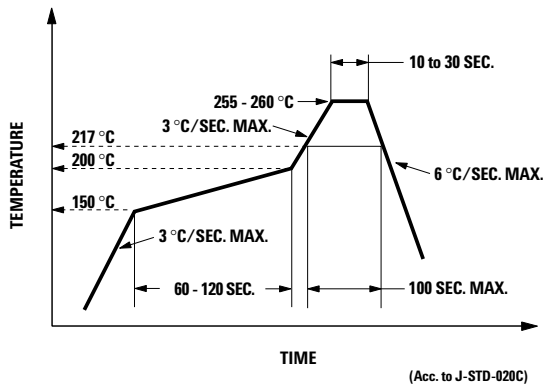

Figure 9. Recommended Pb-free reflow soldering profile.

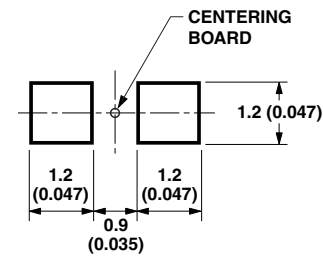

Figure 10. Recommended soldering pattern for HSMx-C177.

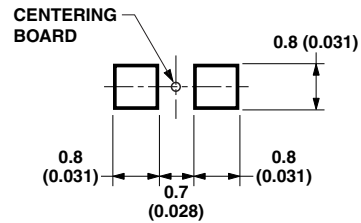

Figure 11. Recommended soldering pattern for HSMx-C197.

NOTE:  
1. ALL DIMENSIONS IN MILLIMETERS (INCHES).

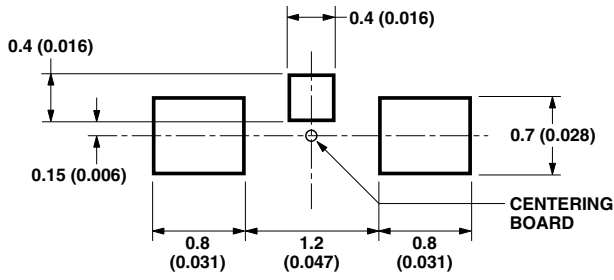

Figure 12. Recommended soldering pattern for HSMx-C120.

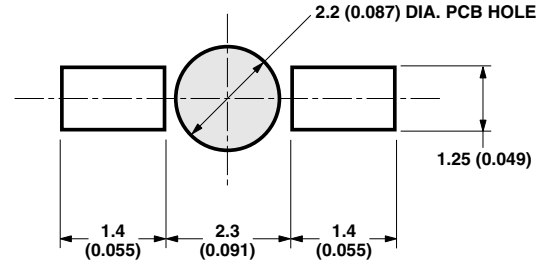

Figure 13. Recommended soldering pattern for HSMx-C265.

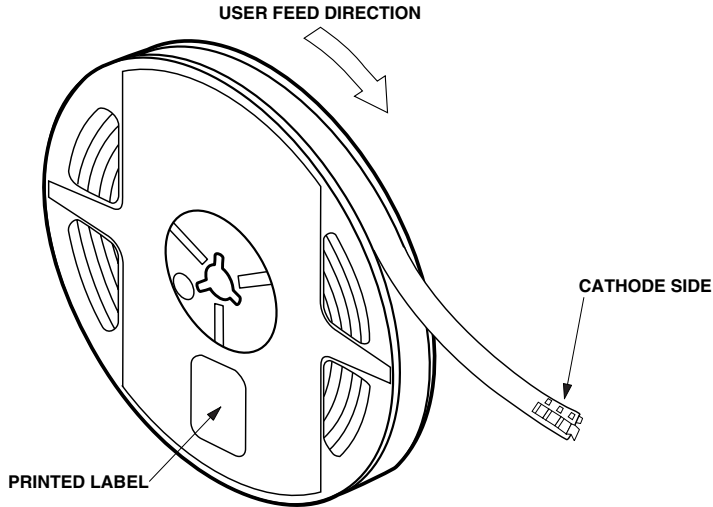

Figure 14. Reeling orientation.

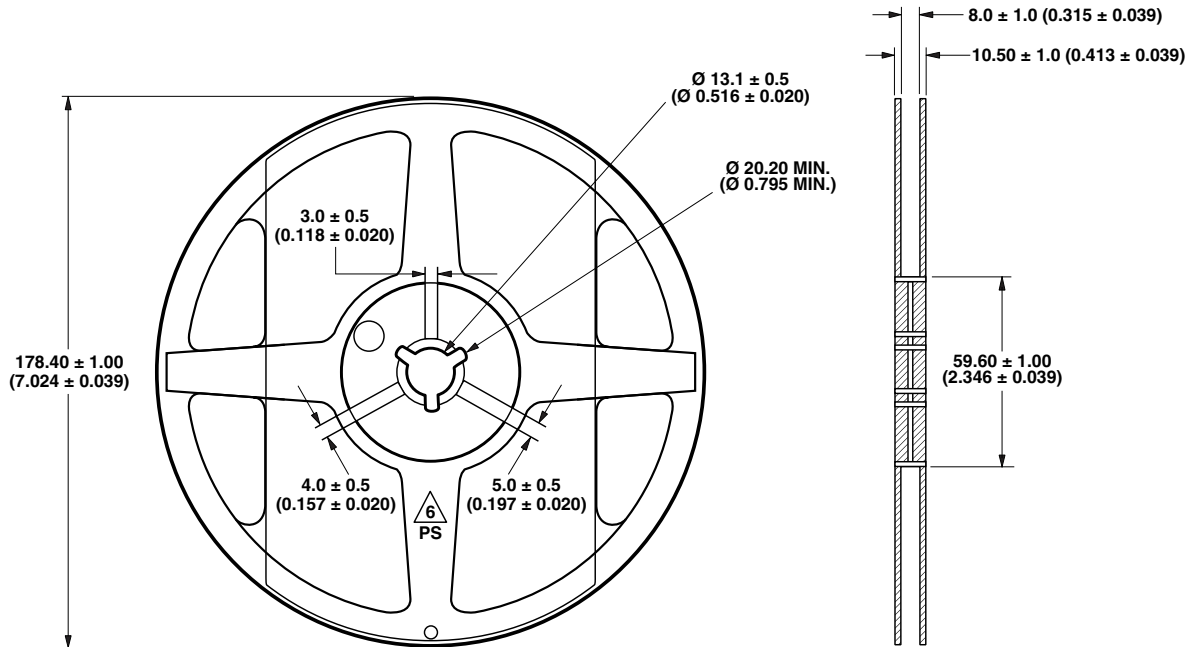

Figure 15. Reel dimensions.

NOTE:  
1. ALL DIMENSIONS IN MILLIMETERS (INCHES).



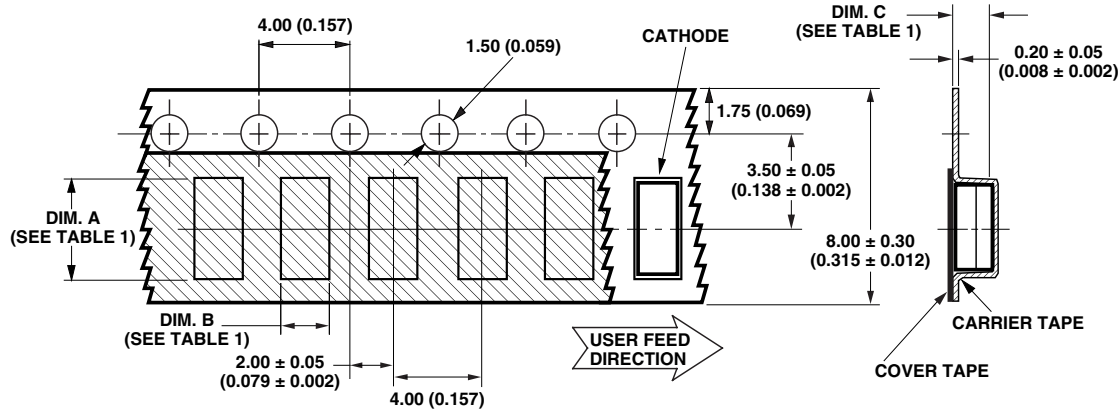

TABLE 1  
DIMENSIONS IN MILLIMETERS (INCHES)

| PART NUMBER      | DIM. A<br>± 0.10 (0.004) | DIM. B<br>± 0.10 (0.004) | DIM. C<br>± 0.10 (0.004) |
|------------------|--------------------------|--------------------------|--------------------------|
| HSMx-C120 SERIES | 1.90 (0.075)             | 1.15 (0.045)             | 0.75 (0.030)             |
| HSMx-C177 SERIES | 2.30 (0.091)             | 1.40 (0.055)             | 0.60 (0.024)             |
| HSMx-C197 SERIES | 1.75 (0.069)             | 0.95 (0.037)             | 0.60 (0.024)             |

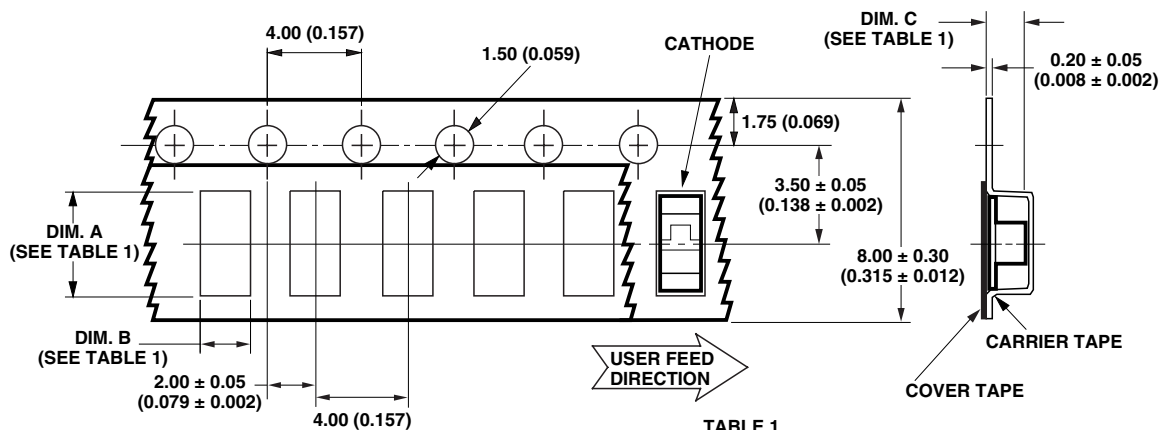
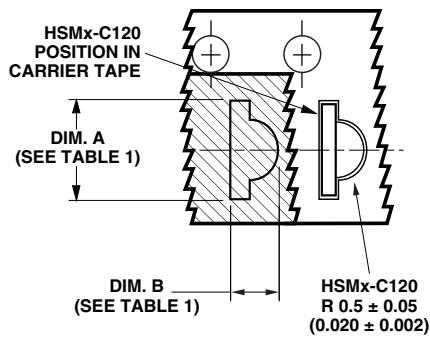

TABLE 1  
DIMENSIONS IN MILLIMETERS (INCHES)

| PART NUMBER      | DIM. A<br>± 0.10 (0.004) | DIM. B<br>± 0.10 (0.004) | DIM. C<br>± 0.10 (0.004) |
|------------------|--------------------------|--------------------------|--------------------------|
| HSMx-C265 SERIES | 3.70 (0.146)             | 1.45 (0.057)             | 1.30 (0.051)             |

Figure 16. Tape dimensions.

NOTES:

1. ALL DIMENSIONS IN MILLIMETERS (INCHES).
2. TOLERANCE IS ± 0.1 mm (± 0.004 IN.) UNLESS OTHERWISE SPECIFIED.

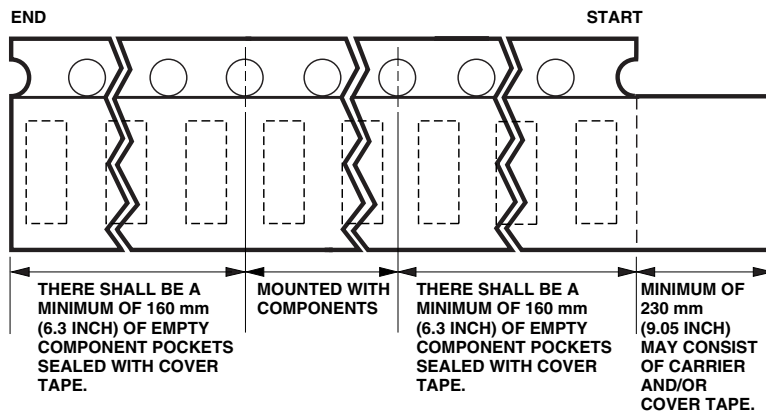

Figure 17. Tape leader and trailer dimensions.

### Convective IR Reflow Soldering

For more information on IR reflow soldering, refer to Application Note 1060, *Surface Mounting SMT LED Indicator Components*.

### Storage Condition:

**5 to 30°C @ 60% RH max.**

Baking is required under the condition:

- Humidity Indicator Card is >10% when read at  $23 \pm 5^\circ\text{C}$
- Device exposed to factory conditions <30°C/60% RH more than 672 hours.

Baking recommended condition:  $60 \pm 5^\circ\text{C}$  for 20 hours.

For product information and a complete list of distributors, please go to our website: [www.avagotech.com](http://www.avagotech.com)

Avago, Avago Technologies, and the A logo are trademarks of Avago Technologies in the United States and other countries. Data subject to change. Copyright © 2005-2009 Avago Technologies. All rights reserved. Obsoletes AV01-0520EN AV02-0975EN - July 9, 2009

**AVAGO**  
TECHNOLOGIES